

IAV **MOMENTUM**



TRAVEL TRAILER TOY HAULER **OWNER'S MANUAL**



Welcome to the Grand Design RV family!

THANK YOU for purchasing a Grand Design recreational vehicle to enjoy the leisure, adventure, and fun of the RV lifestyle. Your new RV has been designed and built to Grand Design's highest quality and safety standards. To keep you and your family safe, our products meet or exceed all applicable state and federal regulations, standards and requirements as well as those of the *Recreational Vehicle Industry Association*.

The Grand Design RV Team and our Dealer Partners pledge to always do our absolute best to provide you with a positive ownership experience as you pursue all of the exciting opportunities this "Grand" lifestyle has to offer.

Please thoroughly read and understand the content of this Owner's Manual and the various component manufacturer manuals included with your RV, paying special attention to any safety precautions (*Dangers, Cautions, Warnings and Notices*). Before camping, learn how to properly operate and maintain all of your recreational vehicle's appliances, components, and systems. Familiarize yourself and your family with the safety features built into your RV, and the actions and steps necessary to ensure safe camping.

Grand Design's *Limited Base Warranty* and *Limited Structural Warranty* are included in this manual. Please read them carefully to fully understand the duration and extent of your coverage as well as the various exclusions and limitations that may apply. Our component suppliers may also provide additional warranties that extend coverage beyond our *Limited Base Warranty*. Please be sure to read all component warranty information found in your Owner Information Package and submit any required registration forms. ***Failure to perform required maintenance could void your warranty.*** Know that some ongoing maintenance is required and must be performed at specified intervals for your warranty to remain in effect.

All of us at Grand Design RV and your Grand Design Dealer THANK YOU again for your purchase. We wish you many safe and happy journeys in your new RV and a lifetime of fond memories.

This page is intentionally blank.



Travel Trailer Owner's Manual

Introduction	1
Reporting Safety Defects	6
Service & Warranty	7
Grand Design RV One Year Limited Base Warranty	13
Grand Design RV Three Year Limited Structural Warranty	19
Component Supplier Contact Information	26
Component Manufacturer Warranty Information	27
Occupant Safety	29
Pre-Travel Information	49
Towing & Leveling	67
Electrical Systems	79
Plumbing Systems	91
Water Heater Bypass Valves	104
Winterization Valve	105
Propane System	111
Appliances	119
Electronics	121
Heating & Cooling	125
Slideout Systems	132
Garage	136
Patio Rail Kit	138
Interior Care	141
Exterior Care	146
Maintenance	155
Required Maintenance Schedule	156
Basic Troubleshooting	158
Glossary	167
Index	177
Maintenance Record	180

This page is intentionally blank.

Introduction

About This Manual

You are responsible for the safe operation and use of your recreation vehicle (RV). This manual is designed to guide you through the normal operation, safety, care, and maintenance of your RV. The procedures outlined are typical for normal operating conditions. We include tips to help you enjoy the RV lifestyle; however, this guide is not intended to teach you how, or where, to camp.

There is nothing in this manual that creates any warranty, expressed or implied. Information in this manual is not meant to in any way supplement, modify, or alter the terms and conditions of the Limited Base Warranty, Limited Structural Warranty, or any component manufacturer warranties.

The information in this manual is accurate at the time of publication but is subject to change without notice. Due to ongoing upgrades and improvements, some photographs, drawings, components, or systems described may not represent what is actually in your RV.

If you have any questions, concerns, or require assistance regarding any aspect of your RV, please contact your dealer or Grand Design RV Customer Service.

Contact Information:

Website: www.granddesignrv.com
Email: customerservice@granddesignrv.com
Phone: (574) 825-9679
Fax: (574) 825-9249
Address: Customer Service
Grand Design RV
11356 County Road 2
Middlebury, IN 46540



Owner Information Package

 This manual and the owner information package should be considered a permanent part of the RV. If the RV is sold, both of these should remain with the RV for the next owner.



Owner Information Package

The Owner Information Package contains the manual and registration cards for several individual components of your new Momentum M.A.V. Travel Trailer (TT).

- It is critical that you register and activate each component warranty within the prescribed time limits to avoid loss of warranty coverage.
 - **Some manufacturers require online registration through their company website.**
 - See **page 26**, *Component Supplier Contact Information*.
- Some component manufacturers offer warranties beyond the Grand Design Limited Base and Structural Warranties.
- Other components are warranted separately and exclusively by the individual component manufacturer, and are therefore excluded from our Limited Base and Structural Warranties.
- **BEFORE using your RV, it is important that you read and understand the information in this manual and your Owner Information Package. Some component manuals are ONLY available on the manufacturer's website.**

Manufacturing Certification

All Grand Design RV fifth wheels and travel trailers are built to meet or exceed the thorough safety and manufacturing codes, standards, and regulations of the Recreational Vehicle Industry Association (RVIA).

- Both RVIA and Transport Canada conduct frequent random audits to confirm that our RVs are manufactured to U.S. (RVIA) and Canadian (CSA) standards.
- The RVIA or CSA Group label found on the sidewall next to the entry door certifies that your RV has been constructed to these exacting codes and standards.
- RVs built for sale in Canada may differ to conform to Canadian codes.

 This NOTE symbol is used to identify special attention items, like useful tips, reminders or maintenance items.

Vehicle Identification Number

The unique 17-digit vehicle identification number (VIN) for your RV is stamped on a metal tag permanently attached to the trailer's A-frame. It is also listed on the Federal Certification label.

A breakdown of a typical Grand Design RV VIN is shown in the example below:

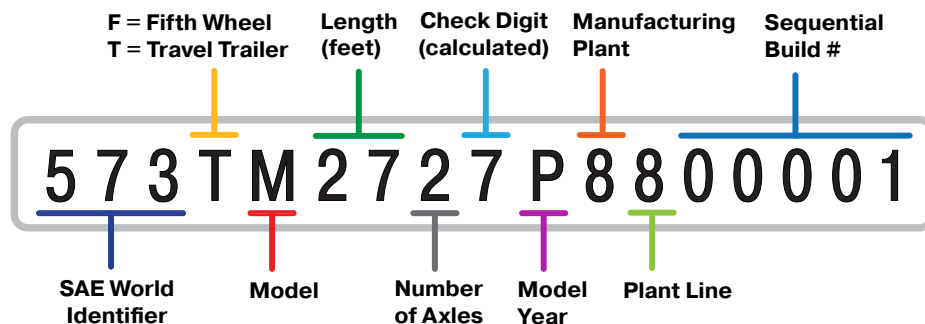

SAE World Identifier:

573 — Grand Design RV

Make / Model:

M — Momentum
S — Solitude
R — Reflection
E — Imagine
T — Transcend

Length:

The number listed falls within a predetermined, specified grouping that does not indicate the actual measured length of your RV.

Model Year:

M — 2021
N — 2022
P — 2023
R — 2024
S — 2025

 The last 8 digits of the VIN number are also the RV's serial number. For the example shown, the serial number is P8800001.



Various safety and information labels are attached to surfaces both inside and outside your RV.

These labels are permanent and should not be removed or relocated for any reason.

Safety Precautions

Nothing is more important than the personal safety of you, your family and others. Safety encompasses several areas related to the RV experience. This includes driving/towing safety, occupant safety, operational safety, environmental safety, and more. Any time you are dealing with carbon monoxide producing appliances, propane gas, electricity and other hazards it is critical that safety become your number one priority in and around your recreational vehicle.



The Safety Alert Symbol is used to alert you to potential personal injury hazards. It is imperative that you read, understand and abide by these safety alerts and messages to avoid possible personal injury or death.



DANGER

DANGER indicates a hazardous situation which, if not avoided, will result in death or serious injury.



WARNING

WARNING indicates a hazardous situation which, if not avoided, could result in death or serious injury.



CAUTION

CAUTION indicates a hazardous situation which, if not avoided, could result in minor or moderate injury.

NOTICE

NOTICE is used to address practices not related to physical injury. This applies to hazardous situations involving property damage only.

Additional Terminology Used

[Customer Supplied] This denotes aftermarket items not installed or included by Grand Design RV. Items noted as “customer supplied” are not covered by the Limited Base and Structural Warranties. The inclusion of items noted as “customer supplied” does not imply or suggest the availability, application sustainability, or inclusion for any specific unit.

[If so equipped] This denotes items that may be installed by Grand Design on particular RVs. Additionally, some items noted as “if so equipped” can only be included during the manufacturing phase and cannot be added at a later date. The inclusion of items noted as “if so equipped” does not imply or suggest the availability, application sustainability, or inclusion for any specific unit.

[Optional] This denotes items that may be an option on all or particular models. Additionally, some optional items can only be included during the manufacturing phase and cannot be added at a later date. The inclusion of optional items does not imply or suggest the availability, application sustainability or inclusion for any specific unit.

Reporting Safety Defects

In the United States

If you believe your vehicle has a defect, that could cause an accident, injury or death, you should immediately inform the **National Highway Traffic Safety Administration (NHTSA)**, and Grand Design RV.

If the NHTSA receives similar complaints, they may open an investigation. If they determine that a safety defect exists in other vehicles, a recall and remedy campaign may be ordered. The NHTSA does not become involved in individual cases between you, your dealer, or Grand Design RV.

To contact the **NHTSA**,

Website: www.safercar.gov
Address: NHTSA Headquarters
Attn: Administrator
1200 New Jersey Avenue, SE
Washington DC 20590

Toll-free Vehicle
Safety Hotline: 1-888-327-4236
TTY: 1-800-424-9153

Additional motor vehicle safety information is available online at www.safercar.gov

In Canada

If you believe that your vehicle has a defect, which could cause a crash or could cause injury or death, you should immediately inform **Transport Canada's Defect Investigations & Recalls Division**, and Grand Design RV.

To contact **Transport Canada**,

Website: www.tc.gc.ca
Address: Transport Canada
Defect Investigations & Recalls Division
330 Sparks Street
Ottawa ON K1A 0N5
Canada

Toll-free in Canada: 1-800-333-0510

If calling internationally,
or from the Gatineau-Ottawa area: 1-819-994-3328

Service & Warranty

Dealer's Responsibilities

When you buy your new RV, at the time of purchase, your dealer is expected to:

1. **DELIVER your RV in the best condition possible.**
Your RV must pass the dealer's Pre-Delivery Inspection (PDI). This inspection tests all systems and components.
2. PROVIDE an orientation to familiarize you with how to operate all systems and components of your new RV.
3. REVIEW with you, and explain the provisions of the *Limited Base Warranty* and *Limited Structural Warranty*.
4. SEND your completed *Warranty Registration and New Vehicle PDI Check List* to Grand Design RV.
Your registration form is required within 30 days of the delivery date to activate your warranty coverage.
5. ENSURE that you receive a complete Owner Information Package. Assist you with all component manufacturer warranty registrations (ie, locating the model and serial numbers of components as needed).
6. EXPLAIN how to obtain local and out-of-town service for your RV, and its (separately warranted) components, including repairs NOT under warranty.
7. SERVICE all Grand Design RV products.



The Limited Base Warranty and the Limited Structural Warranty are activated *only AFTER* Grand Design RV receives a completed (*signed & dated*) warranty registration form from your dealer.

Owner's Responsibilities

As the owner, you are responsible for the regular care and maintenance of your RV in accordance with this manual and the component manufacturer's instructions.

- it is also your responsibility and obligation to return the RV to an authorized dealer for any warranty repairs and service that may be required.
- Proper maintenance will help avoid situations where the Limited Base Warranty and Limited Structural Warranty will not cover items due to neglect.
- Your dealer is responsible for proper service prior to delivery, and has a continued interest in your satisfaction.
 - We recommend warranty and maintenance services be performed by *your* Grand Design RV dealer.
- it is important to protect yourself and others with insurance coverage for your RV. Your insurance agent can assist you in obtaining the appropriate insurance coverage for personal liability, theft, collision, property damage, etc.



Failure to contact Grand Design RV Customer Support, unauthorized or improper warranty repairs, or not returning requested original parts may result in loss of reimbursement and/or loss of warranty.

Obtaining Warranty Service

Warranty service must be obtained:

- WITHIN a reasonable time after the discovery of a defect, *and*
- BEFORE the applicable warranty period expires.

To help your dealer provide you the best level of service, please do the following:

Call ahead

It is best to have your service performed several weeks before you plan to use your RV. Your dealer may need some time to get you in their schedule. Most service departments are the busiest on Mondays, Fridays and before holidays.

Be prepared

Keep your warranty and service history paperwork available. Past repairs and maintenance records may help the service technician diagnose a current issue.

Make a list

Provide the dealer a prioritized list of all repairs needed. If you need your RV returned by a specific date, discuss this with the dealer's service management. A second appointment may be required to complete lower priority list items or if parts need to be ordered.

While waiting

If possible, drop off your RV. Usually, customers cannot watch as repair work is performed. Insurance companies may even require that customers not be allowed in the service area.

Inspect the work performed

Inspect all repairs thoroughly. Notify the dealer's service manager of any dissatisfaction right away.

- If you cannot immediately return your RV for repair, make an appointment to return as soon as possible.
- If a problem re-occurs after leaving the dealership, contact the dealer's service manager *and* Grand Design RV Customer Support, to quickly resolve the issue.



Please have the following available when you call:

1. Your name, location and phone number where you can be reached
2. Your RV's 17-digit VIN
3. Date of purchase
4. Contact information for the RV repair facility or dealer
5. Detailed description of the concern
6. If applicable, the component description, serial and model numbers



Promptly report any issue with an RV repair to the management where the work was done. All repair businesses require notification of problems within a specified time limit. Please familiarize yourself with the RV dealer or repair center's policies.

Obtaining Emergency Warranty Repair

A roadside emergency can happen at any time, whether your RV is new or old. If you are traveling, using the following guidelines can help get you back on the road faster.

1. To find the nearest authorized repair center, select **Find a Dealer** listed under **Shopping Tools** on our website www.granddesignrv.com.
2. If there is not an *authorized dealer* near your location, try the following to find a local repair facility:
 - ASK the campground staff for referrals.
 - SEARCH the Internet,
 - CHECK the local telephone book/yellow pages.
 - CONTACT your dealer, *or*
 - Grand Design RV Customer Support.
3. **When you find an authorized dealer or repair facility:**
 - a. CALL the RV repair facility to discuss your situation and make an appointment.
 - ASK how their billing will be handled.
 - They may choose to bill Grand Design RV directly; if not, you are expected to pay them.
 - b. Have the RV repair facility inspect your RV.
 - **BEFORE any work is performed** either the repair facility or you **must** call Grand Design RV Customer Support to discuss applicable warranty coverage.
 - c. Grand Design RV Customer Support will issue an authorization number upon warranty repair approval and advise if any original parts must be returned.
 - d. The repair center should only begin work on your RV **AFTER** the authorization number has been issued.
 - e. **FOR REIMBURSEMENT:** You or the RV repair facility **must** send a copy of your Itemized Repair Bill, **and**
 - **RETURN** all requested parts to Grand Design RV by UPS (regular ground, freight pre-paid) **within 60-days of the completed repair date.**
 - **TO EXPEDITE PROCESSING YOUR WARRANTY CLAIM:** In addition to your Itemized Repair Bill, please include your Name, Address, Phone Number, the RV's 17-digit VIN, and your Authorization Number.
 - *If returning parts*, include a copy of your freight bill.

- f. **INSPECT the completed repair work *thoroughly*.**
- Make sure that you are satisfied with the repair, *BEFORE* you pay or leave the premises.
 - *If you are not satisfied*, immediately communicate this to the management of the RV repair facility.

Obtaining emergency repair assistance on a weekend or after business hours

- *If an authorized Grand Design RV dealer is NOT located nearby*, CONTACT your selling dealer for assistance.
- If your dealer is closed, check with the campground staff, search the Internet, or telephone book/yellow pages to find a local RV repair facility.
- Have the item repaired and contact Grand Design RV Customer Support immediately the following business day.

Replacement Parts

Replacement warranty parts are **ONLY** distributed through *authorized* Grand Design RV dealers and service centers.

- If an original part is no longer available, Grand Design RV or your dealer will try to provide an approved substitute.
- *Also see our website:* granddesignrv.com
Owner Support Archive > Parts Lookup

Aftermarket Installations & Alterations

Aftermarket installations or alterations to your RV's original equipment as distributed by Grand Design RV are **NOT covered by the Limited Base and Structural Warranties**. The special body company, assembler, equipment installer, or up-fitter is solely responsible for warranties on the body or equipment and any alterations (or any effect of the alterations) to any of the parts, components, systems, or assemblies installed by Grand Design RV.

Grand Design RV is not responsible for the safety or quality of design features, materials, or workmanship of any alterations by such suppliers.

Updating Your Contact Information

- **Grand Design RV requests that you please notify us in writing of any change in:**
 - **Address,**
 - **Ownership, or**
 - **if your RV is ever stolen, totaled or destroyed.**
- **Please remember to contact us if you sell your RV or if you have purchased a previously owned (used) Grand Design RV and are NOT the original owner.**

Federal law requires that we keep a record of all Grand Design RV owners in order to reach you promptly in the event of a recall or a customer notification letter. Please help us keep your contact information up to date.

To update your contact information,

Email: customerservice@granddesignrv.com

or Write: Grand Design RV
11356 County Road 2
Middlebury, IN 46540

If you have any questions, please contact Grand Design RV Customer Support at (574) 825-9679.

Grand Design RV ONE YEAR LIMITED BASE WARRANTY

SUMMARY

What does this Warranty cover?

Grand Design RV, LLC (“Warrantor”) provides this One (1) Year (“Warranty Period”) Limited Base Warranty [which begins to run from the earlier of (i) the date of purchase by the original retail consumer purchaser or (ii) when the recreational vehicle is put into service] against certain defects in materials and/or workmanship for the recreational vehicle manufactured by, and workmanship provided directly by, Warrantor arising under normal use and service to the ORIGINAL RETAIL CONSUMER PURCHASER for the Warranty Period of the recreational vehicle. This Warranty only covers material components and parts of the recreational vehicle actually manufactured by and made by Warrantor and labor provided directly by Warrantor but no parts not made or manufactured by Warrantor. In addition to the foregoing and the other limitations and restrictions set for in this limited warranty, this limited warranty only covers a recreational vehicle sold by an authorized warrantor dealer to the original retail customer or its assign (transfer) to another retail purchaser within the warranty period, but only if the warranty for the recreational vehicle is registered in the original vehicle owner’s name within the thirty (30) day start date period set forth above.

THIS WARRANTY CONSTITUTES THE EXCLUSIVE REMEDY FOR ALL DEFECTS OF MATERIAL AND WORKMANSHIP. THIS WARRANTY IS IN LIEU OF ANY AND ALL OTHER EXPRESSED OR IMPLIED WARRANTIES. THERE ARE NO OTHER EXPRESSED OR IMPLIED WARRANTIES BEYOND THOSE SET FORTH HEREIN. THERE ARE NO WARRANTIES WHICH EXTEND BEYOND THE DESCRIPTION ON THE FACE HEREOF. IN ADDITION TO THE EXCLUSIONS SET FORTH IN THIS LIMITED WARRANTY, THIS WARRANTY DOES NOT APPLY TO DAMAGE DUE TO NEGLIGENT USE, MISUSE, ABUSE OR ACCIDENT INVOLVING ANY PART AND/OR ALL OF THE RECREATIONAL VEHICLE, OR THE REPAIR OR ALTERATION OF SUCH RECREATIONAL VEHICLE. ANY REPAIR OR ALTERATION TO THE RECREATIONAL VEHICLE SPECIFICALLY VOIDS THIS WARRANTY. ANY COMMERCIAL USE, RENTAL, OR BUSINESS USE OF THE RECREATIONAL VEHICLE VOIDS THIS AND ALL OTHER WARRANTIES PROVIDED BY WARRANTOR.

The sole remedy for a breach of the warranty is as follows. Defective parts and workmanship will be replaced by the Warrantor, or the Warrantor’s authorized agent, provided that the following terms are met:

1. The Warrantor’s authorized agent must be notified of the covered defect within the warranty period and within Twenty (20) days of when the defect was discovered or should have been discovered by a reasonable person exercising reasonable care according to the terms of this Limited Warranty.
2. The person seeking the replacement of the defective part or labor must be the original retail consumer purchaser, or an assignment to another consumer purchaser within the Warranty Period. Any assignment does not extend the Warrant Period.

Service & Warranty

3. The defective material or workmanship for which the warranty work and/or part is sought must be to the RECREATIONAL VEHICLE itself only.
4. The other terms and conditions of this Limited Warranty must be satisfied.

What types of things are excluded from the Warranty?

This Warranty does not cover:

- a. Defects in any component parts or labor of the recreational vehicle which are not considered the RECREATIONAL VEHICLE or which were not manufactured by Warrantor;
- b. Defects in any items or labor which are covered by a separate warranty from the original manufacturer of any part that is used by Warrantor in the RECREATIONAL VEHICLE;
- c. Deterioration due to normal wear, tear, and exposure;
- d. Repairs or replacements made necessary by negligence, negligent use of, misuse of, abuse of, loading the unit beyond its gross weight limitations, accidents, acts of God, modifications or alterations in or to the RECREATIONAL VEHICLE by anyone, and failure to maintain or care for the RECREATIONAL VEHICLE, and any and all matters which were not within the control of the Warrantor;
- e. Neglect of the recreational vehicle or any part of it;
- f. Repairs or replacements made necessary by reason of a failure of the original retail consumer purchaser or others to follow ordinary maintenance procedures as recommended by the Warrantor or the manufacturer or dealer of the recreational vehicle;
- g. Any defect caused in-transit to or from a dealer or to or from the consumer or by the consumer or another;
- h. Any defects in work, labor, materials or parts not actually manufactured by, performed by or made by Warrantor;
 - i. Tires; Batteries; Optional Generators and certain Appliances & Electronic Entertainment Equipment which is warranted separately by the respective component manufacturer.
 - j. Recreational vehicles purchased anywhere other than from an authorized Warrantor dealer;
 - k. Alterations, modifications or changes to the original design and build of the recreational vehicle;
 - l. Vehicles used for rental, business or disaster relief purposes;
- m. Routine maintenance and adjustments;
- n. Vehicles registered and used outside the U.S. and Canada;
- o. Consequential/incidental expenses (damages) such as service calls, transportation, lodging, food, fuel, etc. NOTE: Some states do not allow the exclusion of incidental or consequential damages, so this exclusion may not apply to you;
- p. Fading, yellowing or aging of exterior materials due to UV or sunlight or weather exposure;
- q. Damage that has occurred as a result of misuse, abuse, neglect, or lack of maintenance;

- r. Damage caused by unregulated water pressure, tank over-fill or plumbing system modifications resulting in flooding of the vehicle;
- s. Damage caused by unprotected electrical hook-ups (home or campground), power surges, lightning, circuit overload or electrical system modifications;
- t. Damage caused by overloading or improper weight distribution;
- u. Damage caused by improper ventilation resulting in excessive condensation which results in water damage and/or mold or mildew;
- v. Damage, fading or deterioration caused by prolonged exposure to natural elements;
- w. Damage caused by infestation by insects or other animals;
- x. Damage caused by the tow vehicle hitch, equalizer, stabilizer, electrical or brake controller system;
- y. Damage caused by the environment or weather, including, but not limited to, flooding, high winds, acid rain, hail, lightning, high heat, extreme cold, etc.
- z. Damage caused by road surface conditions, applications of salt or de-icing chemicals, gravel/sand, ruts, holes, etc.;
- aa. Exterior paint or finish which is warranted independently by the paint manufacturer and/or independent applicator;
- ab. DEFACING: scratches, dents, and rust on any surface of the RECREATIONAL VEHICLE; and
- ac. EXCESS weight on the RECREATIONAL VEHICLE.

WARRANTOR'S OBLIGATIONS - HOW TO GET WARRANTY SERVICES

How Do You Get Service?

In no event shall repair or replacement for a defect be covered under this Warranty unless the repair or replacement occurs at Warrantor's facilities, or Warrantor's designated repair shop or dealer. Upon discovery of any defect covered by this Warranty, you must notify the authorized dealer from whom you purchased the recreational vehicle. Following notification, the recreational vehicle must be taken to the authorized dealer from whom you purchased it for inspection or another authorized dealer, if authorized by Warrantor, or authorized repair shop as directed by Warrantor. Either that dealer or repair shop or Warrantor will undertake appropriate corrective repairs in instances where the defect is covered by this Warranty. Warrantor reserves the right to use or cause the use of alternative parts or components having substantially equal or greater quality.

Warrantor will remedy defects in materials and workmanship covered under this Limited Warranty under normal use and service caused by Warrantor in the RECREATIONAL VEHICLE ONLY of the recreational vehicle. Warranty performance can only be obtained at Warrantor's authorized dealers and service representatives. All costs incurred in transporting this recreational vehicle for warranty service shall be borne by purchaser unless otherwise approved in advance by Warrantor.

Service & Warranty

What are purchaser's obligations?

The purchaser shall give notice to the Warrantor's agent or dealer within Twenty (20) days after it is or should have been discovered, and any action to enforce it shall be commenced not more than three (3) months thereafter; otherwise the Purchaser will have waived any such defect and claim, and any and all damages arising as a result thereof. The purchaser must perform reasonable and necessary maintenance upon the recreational vehicle and use the recreational vehicle in accordance with the manufacturer of the recreational vehicles and Warrantor's directions and recommendations. Among the other requirements under this Warranty, the Purchaser must also:

- Maintain the recreational vehicle in accordance with the maintenance requirements contained in the Owner's Manual;
- Make minor adjustments including (but limited to) doors, drawers, latches, regulators, controls, mechanisms, etc. after 90 days of ownership;
- Maintain all exterior seals and sealant, which must be inspected every 3 months to assure there are no gaps or voids, and correcting as necessary; and
- Return their vehicle to an authorized dealer for repairs.

If you believe that you have a claim under this Warranty, locate and contact your nearest authorized Warrantor dealer to schedule an appointment. Be prepared to provide your vehicle serial number (VIN), date of purchase, and a description of the issue or concern. If you cannot locate a dealer, please go to the Warrantor's web site or contact Warrantor directly for immediate assistance.

What are the Dealer's Responsibilities?

- Perform a walk-through to assure that the customer understands the operation, use and safety requirements of the vehicle;
- Review vehicle warranties, operating manuals and instruction guides; and
- Inform the customer on how to obtain service, locally or while in transit;

Warrantor is not responsible or liable for any failures, breaches, negligence, inattention or problems on the part of the Dealer.

What events discharge Warrantor from the obligations under this Warranty?

Misuse or negligent use, abuse, or accident, neglect, unauthorized alteration, failure to provide reasonable and necessary maintenance including reasonable periodic inspections of the recreational vehicle and/or use of the recreational vehicle for rental, business or commercial use or any other use other than to use the recreational vehicle only for personal use, shall each discharge the Warrantor from any obligation under this Warranty. The recreational vehicle is designed for recreational and personal use.

What do I do to activate warranties of other manufacturers of component parts and goods?

COMPONENT WARRANTIES

As stated above, some components, accessories or equipment are not covered by this Base Limited Warranty. Examples include tires, batteries, optional generators, and some appliance & electronic entertainment equipment. However, those items may have coverage provided by the component manufacturer. These warranties are completely separate from this Limited Base Warranty, and in some cases may be longer and/or have specific coverage provisions and requirements. In order to activate these warranties you may have to complete registration forms, post cards or some other form of notification to the component manufacturer within a specific time period. These forms and documents will be located with the Owner's Materials provided with your new vehicle. You must complete and submit them to the respective manufacturer as quickly as possible, and within the time periods required by those warranties.

DISCLAIMER OF CONSEQUENTIAL, PUNITIVE AND INCIDENTAL DAMAGES

What other conditions or limitations apply to this Warranty?

The original retail purchaser of the recreational vehicle and any person to whom the recreational vehicle is transferred or given or conveyed, and any person who is an intended or unintended user or beneficiary of this Limited Warranty, shall not be entitled to recover from Warrantor any consequential, punitive or incidental damages resulting from any defect in the recreational vehicle, or loss of use, time or revenues. This warranty also excludes costs of transportation to any authorized dealer or service representative or to the Warrantor to get warranty service, loss of use of the recreational vehicle, loss of time, loss of revenues, inconvenience, or other incidental or consequential damage and any punitive damages, with respect to business or property, whether as a result of breach of warranty, negligence, or otherwise.

Some states do not allow the exclusion or limitation or the exclusion may not apply to you.

TO THE EXTENT NOT EXCLUDED IN THIS LIMITED WARRANTY, THE IMPLIED WARRANTY OF MERCHANTABILITY, AN UNWRITTEN WARRANTY THAT THE PRODUCT IS FIT FOR ORDINARY USE, IS LIMITED TO THE WARRANTY PERIOD OF THIS WRITTEN WARRANTY, AND ANY OTHER IMPLIED WARRANTY ARISING BY OPERATION OF LAW ARE SPECIFICALLY LIMITED TO THE WARRANTY PERIOD OF THIS WRITTEN WARRANTY TO THE EXTENT NOT ACTUALLY EXCLUDED IN THIS LIMITED WARRANTY.

IF ANY MODEL OR SAMPLE IS SHOWN TO THE PURCHASER PRIOR TO THE PURCHASE OF THE RECREATIONAL VEHICLE, SUCH SAMPLE OR MODEL WAS MERELY TO ILLUSTRATE A GENERAL TYPE OF QUALITY AND NOT TO REPRESENT THAT THE RECREATIONAL VEHICLE WOULD NECESSARILY CONFORM TO A SAMPLE OR MODEL AND SHALL NOT BE DEEMED TO BE PART OF THE BASIS OF THE BARGAIN OR CREATE ANY EXPRESSED WARRANTIES OR AFFIRMATIONS OR PROMISES.

DISCLAIMER OF EXPRESSED AND IMPLIED WARRANTIES

THE WARRANTOR EXPRESSLY DISCLAIMS ALL IMPLIED WARRANTIES OF MERCHANTABILITY AND FITNESS FOR A PARTICULAR PURPOSE AND ANY OTHER IMPLIED WARRANTIES.

THERE IS NO EXPRESS OR IMPLIED WARRANTY MADE BY WARRANTOR BEYOND THAT CONTAINED IN THE LIMITED WARRANTY ABOVE. THE ABOVE REFERENCED LIMITED WARRANTY IS IN LIEU OF ANY AND ALL OTHER WARRANTIES. TO ACTIVATE THE LIMITED WARRANTY, THE RECREATIONAL VEHICLE MUST BE REGISTERED WITHIN THIRTY (30) DAYS OF THE DATE OF PURCHASE; OTHERWISE, THIS LIMITED WARRANTY WILL NOT BE EFFECTIVE. NO PERSON HAS THE AUTHORITY TO ENLARGE, AMEND, OR MODIFY THIS WARRANTY.

Some states do not allow limitations on how long an implied warranty lasts, so the above limitations may not apply to you.

DESIGN CHANGES

Warrantor reserves the right to change the design of its RECREATIONAL VEHICLE from time to time without notice and without obligation to make corresponding changes in its products previously manufactured.

ATTORNEYS FEES

Any warranty claim asserted or brought in violation of this Limited Warranty, or any claim brought against WARRANTOR, directly or indirectly, under which the Purchaser or any other person or entity seeks to broaden the terms of the Limited Warranty or under which the Purchaser or any other person fails to successfully prevail on any issue or matter of any type or nature, shall entitle Warrantor to recover its costs, damages, and reasonable attorney's fees in connection with the same.

How Does State Law Relate to This Warranty?

This Warranty gives you specific legal rights, and you may also have other rights which vary from state to state.

By registering or having your recreational vehicle registered in your name, or by asserting a claim under this Limited Warranty, Purchaser (and all assigns) is agreeing on behalf of the purchaser and all assigns to be bound by the terms and conditions of this Limited Warranty.

Grand Design RV THREE YEAR LIMITED STRUCTURAL WARRANTY

SUMMARY

What does this Warranty cover?

Grand Design RV, LLC (“Warrantor”) provides this Three (3) Year (“Warranty Period”) Limited Structural Warranty [which begins to run from the earlier of (i) the date of purchase by the original retail consumer purchaser or (ii) when the recreational vehicle is put into service] against certain defects in materials and/or workmanship for the structural components manufactured by, and workmanship provided directly by, Warrantor arising under normal use and service to the structural components (as defined below) for the above described recreational vehicle of Warrantors to the ORIGINAL RETAIL CONSUMER PURCHASER for the Warranty Period. This Warranty only covers material components and parts of the Structural Components actually manufactured by and made by Warrantor and labor provided directly by Warrantor. In addition to the forgoing and the other limitations and restrictions set for in this limited warranty, this limited warranty only covers a recreational vehicle sold to the original retail customer by an authorized warrantor dealer within the thirty (30) day start period set forth above. This Warranty is not assignable to any person or entity.

“Structural Components” consist of: materials and/or workmanship directly attributable to Warrantor, namely, the laminated fiberglass sidewall assembly, laminated fiberglass rear wall assembly, laminated fiberglass front wall (wrap), sidewall/end wall/front and rear wall frame assembly (wood and aluminum), roof assembly, floor assembly and frame assembly.

THIS WARRANTY CONSTITUTES THE EXCLUSIVE REMEDY FOR ALL DEFECTS OF MATERIAL AND WORKMANSHIP. THIS WARRANTY IS IN LIEU OF ANY AND ALL OTHER EXPRESSED OR IMPLIED WARRANTIES. THERE ARE NO OTHER EXPRESSED OR IMPLIED WARRANTIES BEYOND THOSE SET FORTH HEREIN. THERE ARE NO WARRANTIES WHICH EXTEND BEYOND THE DESCRIPTION ON THE FACE HEREOF. IN ADDITION TO THE EXCLUSIONS SET FORTH IN THIS LIMITED WARRANTY, THIS WARRANTY DOES NOT APPLY TO DAMAGE DUE TO NEGLIGENT USE, MISUSE, ABUSE OR ACCIDENT INVOLVING ANY PART AND/OR ALL OF THE STRUCTURAL COMPONENTS, OR THE REPAIR OR ALTERATION OF SUCH STRUCTURAL COMPONENTS. ANY REPAIR OR ALTERATION TO THE STRUCTURAL COMPONENTS SPECIFICALLY VOIDS THIS WARRANTY. ANY COMMERCIAL USE, RENTAL, OR BUSINESS USE OF THE RECREATIONAL VEHICLE VOIDS THIS AND ALL OTHER WARRANTIES PROVIDED BY WARRANTOR.

The sole remedy for a breach of the warranty is as follows. Defective parts and workmanship will be replaced by the Warrantor, or the Warrantor’s authorized agent, provided that the following terms are met:

1. The Warrantor’s authorized agent must be notified of the covered defect within the warranty period and within Twenty (20) days of when the defect was discovered or should have been discovered by a reasonable person exercising reasonable care according to the terms of this Limited Warranty.

Service & Warranty

2. The person seeking the replacement of the defective part or labor must be the original retail consumer purchaser. An assignment of the recreational vehicle to another person voids this Limited Warranty.
3. The defective material or workmanship for which the warranty work and/or part is sought must be to the STRUCTURAL COMPONENTS only.
4. The other terms and conditions of this Limited Warranty must be satisfied.

What types of things are excluded from the Warranty?

This Warranty does not cover:

- a. Defects in any component parts or labor of the recreational vehicle which are not considered the STRUCTURAL COMPONENTS or which were not manufactured by Warrantor;
- b. Defects in any items or labor which are covered by a separate warranty from the original manufacturer of any part that is used by Warrantor in the STRUCTURAL COMPONENTS;
- c. Deterioration due to normal wear, tear, and exposure;
- d. Repairs or replacements made necessary by negligence, negligent use of, misuse of, abuse of, loading the unit beyond its gross weight limitations, accidents, acts of God, modifications or alterations in or to the STRUCTURAL COMPONENTS by anyone, and failure to maintain or care for the STRUCTURAL COMPONENTS, and any and all matters which were not within the control of the Warrantor;
- e. Neglect of the recreational vehicle or STRUCTURAL COMPONENTS;
- f. Repairs or replacements made necessary by reason of a failure of the original retail consumer purchaser or others to follow ordinary maintenance procedures as recommended by the Warrantor or the manufacturer or dealer of the Structural Components;
- g. Any defect caused in-transit to or from a dealer or to or from the consumer or by the consumer or another;
- h. Any defects in work, labor, materials or parts not actually manufactured by, performed by or made by Warrantor;
- i. Front and rear fiberglass caps and any other cosmetic fiberglass attachments;
- j. Sidewall metal (unless the root cause is the wall structure);
- k. Exterior roof material (EPDM rubber, TPO, etc.);
- l. Floor covering (carpet, linoleum, hardwood, tile, etc.);
- m. All sidewall, end wall, front and rear wall, roof and floor attachments;
- n. Delamination caused by water intrusion from lack of required exterior seal maintenance;
- o. Vehicles purchased anywhere other than from an authorized Warrantor dealer;
- p. Alterations, modifications or changes to the original design and build of the recreational vehicle;
- q. Vehicles used for rental, business or disaster relief purposes;
- r. Routine maintenance and adjustments;
- s. Vehicles registered and used outside the U.S. and Canada;

- t. Consequential/incidental expenses (damages) such as service calls, transportation, lodging, food, fuel, etc. NOTE: Some states do not allow the exclusion of incidental or consequential damages, so this exclusion may not apply to you;
- u. Fading, yellowing or aging of exterior materials due to UV or sunlight or weather exposure;
- v. Damage that has occurred as a result of misuse, abuse, neglect, or lack of maintenance;
- w. Damage caused by unregulated water pressure, tank over-fill or plumbing system modifications resulting in flooding of the vehicle;
- x. Damage caused by unprotected electrical hook-ups (home or campground), power surges, lightning, circuit overload or electrical system modifications;
- y. Damage caused by overloading or improper weight distribution;
- z. Damage caused by improper ventilation resulting in excessive condensation which results in water damage and/or mold or mildew;
- aa. Damage, fading or deterioration caused by prolonged exposure to natural elements;
- ab. Damage caused by infestation by insects or other animals;
- ac. Damage caused by the tow vehicle hitch, equalizer, stabilizer, electrical or brake controller system;
- ad. Damage caused by the environment or weather, including, but not limited to, flooding, high winds, acid rain, hail, lightning, high heat, extreme cold, etc.
- ae. Damage caused by road surface conditions (gravel/sand, ruts, potholes, etc.); applications of salt or de-icing chemicals resulting in rust.
- af. Exterior paint or finish which is warranted independently by the paint manufacturer and/or independent applicator;
- ag. Defacing: scratches, dents, and rust on any surface of the STRUCTURAL COMPONENTS; and
- ah. Excess weight on the STRUCTURAL COMPONENTS.

WARRANTOR'S OBLIGATIONS - HOW TO GET WARRANTY SERVICES

How Do You Get Service?

In no event shall repair or replacement for a defect be covered under this Warranty unless the repair or replacement occurs at Warrantor's facilities, or Warrantor's designated repair shop or dealer. Upon discovery of any defect covered by this Warranty, you must notify the authorized dealer from whom you purchased the recreational vehicle. You must always notify the Warrantor as well even if you contact the dealer from whom you purchased the recreational vehicle. Following notification, the recreational vehicle must be taken to the authorized dealer from whom you purchased it for inspection or another authorized dealer, if authorized by Warrantor, or authorized repair shop as directed by Warrantor. Either that dealer or repair shop or Warrantor will undertake appropriate corrective repairs in instances where the defect is covered by this Warranty. However, no work may be performed to the STRUCTURAL COMPONENTS without the prior authorization of the Warrantor. And, Warrantor reserves the right to use or cause the use of alternative parts or components having substantially equal or greater quality.

Service & Warranty

Warrantor will remedy defects in materials and workmanship covered under this Limited Warranty under normal use and service caused by Warrantor in the STRUCTURAL COMPONENTS ONLY of the recreational vehicle. Warranty performance can only be obtained at Warrantor's authorized dealers and service representatives. All costs incurred in transporting this recreational vehicle for warranty service shall be borne by purchaser unless otherwise approved in advance by Warrantor.

What are purchaser's obligations?

The purchaser shall give written notice to the Warrantor or an Authorized Dealer of any defect within Twenty (20) days after it is or should have been discovered, and any action to enforce it shall be commenced not more than three (3) months thereafter; otherwise the Purchaser will have waived any such defect and claim, and any and all damages arising as a result thereof. The purchaser must perform reasonable and necessary maintenance upon the recreational vehicle and STRUCTURAL COMPONENTS and use the recreational vehicle and STRUCTURAL COMPONENTS in accordance with the recreational vehicle manufacturer and Warrantor's directions and recommendations. Among the other requirements under this Warranty, the Purchaser must also:

- Maintain the recreational vehicle in accordance with the maintenance requirements contained in the Owner's Manual; and
- Maintain all exterior seals and sealant, which must be inspected every six (6) months to assure there are no gaps or voids, and all gaps and voids must be corrected as necessary. Documentation acceptable to Warrantor must be presented confirming completion of an annual sealant inspection by an authorized Warrantor dealer or authorized dealer repair shop for coverage consideration.

If you believe that you have a claim under this Warranty, locate and contact your nearest authorized Warrantor dealer to schedule an appointment. Be prepared to provide your vehicle serial number (VIN), date of purchase, and a description of the issue or concern. If you cannot locate a dealer, please go to the Warrantor's web site or contact Warrantor directly for immediate assistance.

What events discharge Warrantor from the obligations under this Warranty?

Misuse or negligent use, abuse, or accident, neglect, unauthorized alteration, failure to provide reasonable and necessary maintenance including reasonable periodic inspections of the recreational vehicle and STRUCTURAL COMPONENTS and/or use of the recreational vehicle for rental, business or commercial use or any other use other than to use the recreational vehicle only for personal use, shall each discharge the Warrantor from any obligation under this Warranty. The Structural Components in the recreational vehicle are designed for recreational and personal use.

DISCLAIMER OF CONSEQUENTIAL, PUNITIVE AND INCIDENTAL DAMAGES

What other conditions or limitations apply to this Warranty?

The original retail purchaser of the recreational vehicle and any person to whom the recreational vehicle is transferred or given or conveyed, and any person who is an intended or unintended user or beneficiary of this Limited Warranty, shall not be entitled to recover from Warrantor any consequential, punitive or incidental damages resulting from any defect in the recreational vehicle, or loss of use, time or revenues. This warranty also excludes costs of transportation to any authorized dealer or service representative or to the Warrantor to get warranty service, loss of use of the recreational vehicle, loss of time, loss of revenues, inconvenience, or other incidental or consequential damage and any punitive damages, with respect to business or property, whether as a result of breach of warranty, negligence, or otherwise

Some states do not allow the exclusion or limitation or the exclusion may not apply to you.

TO THE EXTENT NOT EXCLUDED IN THIS LIMITED WARRANTY, THE IMPLIED WARRANTY OF MERCHANTABILITY, AN UNWRITTEN WARRANTY THAT THE PRODUCT IS FIT FOR ORDINARY USE, IS LIMITED TO THE WARRANTY PERIOD OF THIS WRITTEN WARRANTY, AND ANY OTHER IMPLIED WARRANTY ARISING BY OPERATION OF LAW ARE SPECIFICALLY LIMITED TO THE WARRANTY PERIOD OF THIS WRITTEN WARRANTY TO THE EXTENT NOT ACTUALLY EXCLUDED IN THIS LIMITED WARRANTY.

IF ANY MODEL OR SAMPLE IS SHOWN TO THE PURCHASER PRIOR TO THE PURCHASE OF THE RECREATIONAL VEHICLE/STRUCTURAL COMPONENTS, SUCH SAMPLE OR MODEL WAS MERELY TO ILLUSTRATE A GENERAL TYPE OF QUALITY AND NOT TO REPRESENT THAT THE RECREATIONAL VEHICLE/STRUCTURAL COMPONENTS WOULD NECESSARILY CONFORM TO A SAMPLE OR MODEL AND SHALL NOT BE DEEMED TO BE PART OF THE BASIS OF THE BARGAIN OR CREATE ANY EXPRESSED WARRANTIES OR AFFIRMATIONS OR PROMISES.

DISCLAIMER OF EXPRESSED AND IMPLIED WARRANTIES

THE WARRANTOR EXPRESSLY DISCLAIMS ALL IMPLIED WARRANTIES OF MERCHANTABILITY AND FITNESS FOR A PARTICULAR PURPOSE AND ANY OTHER IMPLIED WARRANTIES.

THERE IS NO EXPRESS OR IMPLIED WARRANTY MADE BY WARRANTOR BEYOND THAT CONTAINED IN THE LIMITED WARRANTY ABOVE. THE ABOVE REFERENCED LIMITED WARRANTY IS IN LIEU OF ANY AND ALL OTHER WARRANTIES. TO ACTIVATE THE LIMITED WARRANTY, YOU MUST RETURN THE ATTACHED NOTICE TO WARRANTOR WITHIN THIRTY (30) DAYS OF THE DATE OF PURCHASE; OTHERWISE, THIS LIMITED WARRANTY WILL NOT BE EFFECTIVE. NO PERSON HAS THE AUTHORITY TO ENLARGE, AMEND, OR MODIFY THIS WARRANTY

Some states do not allow limitations on how long an implied warranty lasts, so the above limitations may not apply to you.

DESIGN CHANGES

Warrantor reserves the right to change the design of its STRUCTURAL COMPONENTS from time to time without notice and without obligation to make corresponding changes in its products previously manufactured.

ATTORNEYS FEES

Any warranty claim asserted or brought in violation of this Limited Warranty, or any claim brought against WARRANTOR, directly or indirectly, under which the Purchaser or any other person or entity seeks to broaden the terms of the Limited Warranty or under which the Purchaser or any other person fails to successfully prevail on any issue or matter of any type or nature, shall entitle Warrantor to recover its costs, damages, and reasonable attorney's fees in connection with the same.

How Does State Law Relate to This Warranty?

This Warranty gives you specific legal rights, and you may also have other rights which vary from state to state

What to do if a separately manufactured part is defective?

Our warranty does not cover defects in separately manufactured products which are not produced or manufactured directly by Warrantor. These products may be warranted by their individual manufacturers. To the extent that such products installed in your recreational vehicle or STRUCTURAL COMPONENTS are covered by warranties from those manufacturers, the written warranties by the suppliers of those products may be provided with each new recreational vehicle for the convenience and clarification of the original retail consumer purchaser. If you have trouble locating the manufacturer supplying these warranties, your dealer will be glad to assist you. However, we have no responsibility or control over the outcome of warranty claims against these manufacturers.

How Does State Law Relate to This Warranty?

This Warranty gives you specific legal rights, and you may also have other rights which vary from state to state.

By registering, or having your recreational vehicle registered in your name, or by asserting a claim under this Limited Warranty, Purchaser (and all assigns) is agreeing on behalf of Purchaser and all assigns to be bound by the terms and conditions of this Limited Warranty.

This page is intentionally blank.

Component Supplier Contact Information

All component suppliers listed are correct at the time of printing. Grand Design RV may change components at their discretion. Please contact GDRV Customer Support with any questions.

Component	Brand	Supplier Website	Phone Number
Air conditioner	Furrion	furrion.com	(888) 354-5792
Awning(s)	Lippert / Solera	lci1.com	(574) 537-8900
Axle	Lippert	lci1.com	(574) 537-8900
Converter / Inverter	WFCO	wfcoelectronics.com	(877) 294-8997
Entry Door	Lippert	lci1.com	(574) 537-8900
Entry Steps	Elkhart Tool & Die	elkharttool.com	(574) 295-8500
Exterior Side Metal	Amerimax	amerimaxfp.com	(574) 773-7981
Exterior Side Metal	Lippert	lci1.com	(574) 537-8900
Frame / Chassis	Lippert	lci1.com	(574) 537-8900
Furnace	Suburban	airxcel.com	(423) 775-2131
Graphics	Vomela	vomela.com	(651) 228-2200
Load Center	WFCO	wfcoelectronics.com	(877) 294-8997
Microwave	Furrion	furrion.com	(888) 354-5792
Power Tongue Jack	Lippert	lci1.com	(574) 537-8900
Range Hood	Furrion	furrion.com	(888) 354-5792
Range Top / Oven Combo	Furrion	furrion.com	(888) 354-5792
Refrigerator	Furrion	furrion.com	(888) 354-5792
Roof Membrane	Alpha Systems	alphallc.us	(800) 462-4698
Slideout(s)	Lippert	lci1.com	(574) 537-8900
Solar Charging System	Furrion	furrion.com	(888) 354-5792
Stereo / Speakers (Premium)	Rockford Fosgate	teamprogressive.com	(800) 366-2349
Television	TCL	tclusa.com	(877) 300-8837
TV Antenna	Winegard Company	winegard.com	(800) 288-8094
Thermostat	Furrion	furrion.com	(888) 354-5792
Tires	West Lake	lionsheadtireandwheel.com	(574) 533-6169
Toilet	Aqua Magic	thetford.com	(800) 543-1219
Water Heater	Suburban	airxcel.com	(423) 775-2131
Water Pump	Seaflor	rangerdistribution.com	(574) 891-4994
Windows	Lippert	lci1.com	(574) 537-8900

Component Manufacturer Warranty Information

Each manufacturer provides their own warranty for the components on your Momentum M.A.V. TT. This warranty information is accurate at time of printing, but subject to change at any time per the manufacturer. Details can be found on the company websites listed or by contacting them directly. See **previous page**, *Component Supplier Contact Information*.

Component	Brand	Manufacturer Warranty
Air conditioner	Furrion	Two year limited parts and service warranty.
Awning(s)	Lippert / Solera	One year limited warranty from date of purchase.
Axle	Lippert	Six year limited warranty from date of purchase.
Converter / Inverter	WFCO	Two year limited warranty.
Entry Door	Lippert	One year limited warranty from date of purchase.
Entry Steps	Elkhart Tool & Die	One year limited warranty.
Exterior Side Metal	Amerimax	Two year limited warranty on surface coating.
Exterior Side Metal	Lippert	Two year limited warranty on surface coating.
Frame / Chassis	Lippert	One year limited warranty from date of purchase.
Furnace	Suburban	Two year limited warranty.
Graphics	Vomela	Five year limited warranty.
Load Center	WFCO	Two year limited warranty.
Microwave	Furrion	One year limited warranty from date of purchase.
Power Tongue Jack	Lippert	One year limited warranty from date of purchase.
Range Hood	Furrion	One year limited warranty from date of purchase.
Range Top / Oven Combo	Furrion	One year limited warranty from date of purchase.
Refrigerator	Furrion	Two year limited warranty from date of purchase.
Roof Membrane	Alpha Systems	Limited lifetime warranty.
Slideout(s)	Lippert	One year limited warranty from date of purchase.
Solar Charging System	Furrion	One year limited warranty from date of purchase.
Stereo / Speakers (Premium)	Rockford Fosgate	Two year limited warranty
Television	TCL	One year limited warranty.
TV Antenna	Winegard Company	Two year limited warranty, Parts. One year limited warranty, Labor.
Thermostat	Furrion	One year limited warranty from date of purchase.
Tires	West Lake	No fault 12-month limited warranty from the date of purchase. Five year limited warranty from the tire manufacture date.
Toilet	Aqua Magic	One year limited warranty.
Water Heater	Suburban	Two year limited warranty
Water Pump	Seaflo	One year limited warranty.
Windows	Lippert	One year limited warranty from date of purchase.

This page is intentionally blank.

Occupant Safety

Your Momentum M.A.V. Travel Trailer is designed with safety as the top priority. This RV meets or exceeds the safety standards and applicable codes in effect at the time it is built. All required safety items are carefully installed to protect you and the occupants of your RV.

Family Safety Plan

Develop a *Family Safety Plan* to use in case of an emergency or severe weather condition. Practice it with your entire family, especially children.

- Before camping, please review and understand the locations of all doors, emergency exit windows, and safety equipment inside your RV.
- Teach everyone what the RV safety alarm signals mean and how to be prepared to leave the RV, by themselves if necessary.
- Draw a floor plan of your RV and find two ways to exit. There should be at least one way to get out of your RV without opening the door.
- Teach everyone how to *check doors* (and *not* to open them if they are **hot**). Also teach everyone to *stay low* to try to avoid breathing smoke, fumes or gases.
- Decide on a meeting place a safe distance from your RV. Make sure everyone understands to gather and wait there, in case family members are separated from one another in an emergency.
- Make sure everyone knows where to go to call the fire department or 911 from outside the RV.
- Conduct safety drills at least every six months.
 - Make sure everyone, guests included, knows how to evacuate the RV safely.
- Practice exiting the RV blindfolded; in a real fire situation, thick black smoke can make it impossible to see.
- Ask an out-of-state relative or friend to serve as your *family contact*. Make sure everyone knows the contact person's name, address, phone number and email.

For additional safety precautions, Consult your local fire dept.

WARNING

During severe weather conditions, move indoors to a place of safety or shelter as directed by campground or other appropriate authorities.

- AVOID trees or power lines that could fall on your vehicle.
- The safest place during severe weather conditions is inside a basement or storm shelter, not an RV or tow vehicle.

WARNING

Be aware of the **Heat Index** if camping during hot weather.

KEEP HYDRATED, and try to stay indoors in an AIR CONDITIONED area during a high Heat Index Warning.

Pet Safety

Emergency shelters could refuse to admit pets due to health or space reasons. The survival of a beloved pet often depends on the careful plans their owner has made in advance.

- Prepare an emergency plan for pets that includes a **3-day supply** (*at least*) of dry food and fresh water.

Emergency Weather Planning

Weather conditions can change with little, or even no warning. While camping, always be prepared for the possibility of severe weather. Thunderstorms, hail, flooding, hurricanes, tornadoes, earthquakes, etc. can threaten your safety and damage your tow vehicle or RV.

Local radio and TV stations normally broadcast weather conditions and warnings as they occur. Research other methods of learning about severe weather conditions and how to deal with them. You may want to consider investing in a weather radio. Weather radios offer 24 hour-a-day VHF broadcasts of weather observations and forecasts directly from the US National Weather Service (NWS).

The frequencies used by the US National Oceanic and Atmospheric Administration (NOAA) weather radio stations are 162.400, 162.425, 162.450, 162.475, 162.500, 162.525, or 162.550 megahertz or visit their website www.noaa.gov

Repairing severe weather damage

If your RV (or tow vehicle) is damaged due to severe weather, **BEFORE** scheduling any repair work:

- **CALL your insurance company to report your claim as soon as possible.**



Please familiarize yourself with the following weather terms:

Warning - indicates that a particular weather hazard is either imminent or has been reported.

Move to a safe location immediately. Take action to protect life and property. The type of hazard is named in the type of warning (tornado warning, blizzard warning, etc.).

Watch - indicates that a particular weather hazard is possible and that conditions are favorable for its occurrence.

A watch is a time for preparation, planning, and increased awareness. Stay alert for changing weather, listen for further information and think about what to do if the danger materializes.

Fire Safety

Please **AVOID** the three (3) most common Fire Safety issues: **Smoking In Bed, Using Flammable Solvents/Cleaning Fluids, and Leaving Children Unattended.**

- In a fire emergency, **EVACUATE** the RV *first*, then call 911 from a safe location.
- In a fire emergency, execute your *Family Safety Plan*.
- Make sure everyone knows to **Stop, Drop & Roll** if their clothes catch fire.
 - **Stop** in place, do not run.
 - **Drop** to the ground.
 - **Roll** back and forth, with hands shielding face from the fire.
- Supervise children around any open flame, especially grills, and campfires.
- Learn and teach safe fire practices. Build campfires away from nearby trees or bushes.
- Maintain at least a three-foot *clear area* around grills, campfires and tents, that is free of leaves, dry grass, pine needles, etc.
- ALWAYS have a way to quickly and completely extinguish a campfire ready *in advance*. NEVER leave a fire burning unattended, even a cigarette.
- Teach family members how to use the fire extinguisher and replace it as recommended.
- DO NOT store combustible materials in closed areas or near a heat source.
- DO NOT use water to put out a grease fire. Water can spread some types of fire and create an electrocution hazard during an electrical fire.
- ALWAYS call the Fire Department, No matter how small the fire.

More information on firefighting can be found at the National Fire Protection Association website (www.nfpa.org).



NOTIFY Grand Design RV Immediately

if you feel that product failure resulted in a fire.

Call GDRV Customer Service at **(574) 825-8000** for approval BEFORE the RV is entered, moved or repaired, or any debris is cleaned/removed.

Failure to notify GDRV could result in the loss of coverage.

Fire Extinguisher

A fire can spread very fast. BEFORE using the fire extinguisher, remember that **safe escape** is the most important part of any fire response plan. ***If there is a fire in or around your RV:***

- **EVACUATING all occupants from the RV safely, must be your number one (#1) priority.**

A dry chemical, Class B /Class C type fire extinguisher is located near the entry door of your RV. The portable fire extinguisher can be used to put out small fires or contain one until the fire department arrives. Portable extinguishers do have limitations.

Household fire extinguishers are classified into four types by Underwriters Laboratories (UL):

Rating	Intended Use
Type A	For use on fires involving combustible materials such as wood, cloth and paper.
Type B	For use on flammable liquid fires, including kitchen grease. <i>NEVER use water on this type of fire.</i>
Type C	For use on fires involving energized electrical equipment.
Type ABC	Works on all three types of fires listed above.

Operation

When you use the fire extinguisher:

1. **ALWAYS keep your back to a clear exit for easy escape.**
2. **LEAVE immediately if the fire cannot be controlled or the room fills with smoke.**

There are different types and sizes of fire extinguishers, but for the most part, they all work the same.

To operate a fire extinguisher, remember the word: P.A.S.S.

PULL the pin. Hold the extinguisher with the nozzle pointing away from you, and release the locking mechanism.

AIM low. Point the extinguisher at the base of the fire.

SQUEEZE the lever slowly and evenly.

SWEEP the nozzle from side-to-side until the fire is out.

 **CAUTION**

AVOID inhaling the dry chemical agent in the fire extinguisher. It is not toxic but may cause skin irritation.

In case of contact:
FLUSH the affected area with clean, cool water.
If irritations persists, contact a physician immediately.

Disposal

Please check the local laws BEFORE disposing of your used (non-refillable) dry chemical fire extinguisher. Contact your local fire, sanitation or environmental protection department for rules on disposal.

Emergency Egress Window

The *Emergency Egress Window (or exit window)* is your secondary exit, if the RV's entrance door becomes blocked or unavailable. All egress windows are marked with an *EXIT* label (*right*) and have **red** handles or levers. Depending upon the window type, an egress window may be a large section or an entire window. Learn and practice how to open and operate the egress window before an emergency occurs:

- When pulling into your campsite, make sure the egress windows are not blocked by trees or other obstacles.
- Also check that below each egress window the ground is solid and the escape path is clear.
- Review the egress window locations and how to operate them with all people staying in the RV.
- Plan escape routes from the front and rear of the RV.
- Decide who will exit through the emergency escape windows first, and in what position.
- Place a blanket or heavy coat over the window frame to cushion the exit.
- If there is a fire, the last person to exit the RV should be prepared to assist those in front.
- Arrange for a meeting place safely away from the RV.

Maintenance

- To prevent the seals from sticking, OPEN and CLOSE your *Emergency Egress Window(s)* each trip.
- During transit the *Egress Window(s)* **must** be locked.

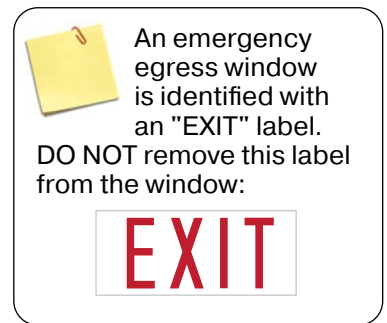



Smoke Alarm

WARNING

Test Smoke Alarm operation after the RV has been in storage, before each trip and at least once per week during use.

WARNING

NEVER use an open flame from a match or lighter to test the smoke alarm; you may accidentally ignite and set fire to the smoke alarm and your RV. If the smoke alarm does not test properly, replace it immediately.



DURING TESTING:

You will hear a loud, repeating horn pattern and the red LED will flash rapidly on the smoke alarm.

Smoke Alarm

The smoke alarm is located on the ceiling in the main living area of your RV. It is intended to help reduce injury or loss of life in a fire. Proper use can give you time to escape, but they are not foolproof. Smoke alarms only sound when smoke reaches them.

- Smoke alarms **MUST** be properly located, installed, and maintained.
- **Individuals with hearing loss or certain medical problems should consider using warning devices that provide both audible and visual signals**

Operation

- Check that a 9-volt battery is correctly connected.
- When the battery is supplying power, the red LED will flash.
- *If smoke is detected by the sensor*, a loud alarm will sound until the air is cleared.

If the smoke alarm sounds

During an alarm, you will hear a loud, repeating horn pattern and the red LED will flash rapidly.

- The alarm warns you of a potentially dangerous situation that **requires your immediate attention**.
- **NEVER ignore any alarm.** Ignoring the alarm may result in injury or death.
- EVACUATE the RV first, *then*
- Call 911 from a safe location.

How to test

TEST the smoke alarm at least once EVERYWEEK to make sure that it is working properly. Stand at arm's length from the alarm when testing. **The alarm horn is loud and may be harmful to your hearing.**

1. PRESS and HOLD the *TEST/SILENCE* button on the smoke alarm cover until the alarm sounds. The alarm may continue for a few seconds after you release the button.
2. If the alarm does not sound, check that it is receiving power, *then* TEST it again.
3. CHECK that the CO Alarm is clean and dust-free.
4. *If it still does not alarm*, REPLACE it immediately.

Battery

The smoke alarm will NOT function **if the battery is:**

- Missing, Disconnected, or Dead.
- Installed incorrectly
- The wrong type.

REPLACE the 9-volt battery in your Smoke Alarm when it *chirps* (*the low battery warning*). NEVER disconnect the battery to silence the smoke alarm.

- **When the *low battery warning* sounds, the battery MUST be replaced to continue your protection.**

Maintenance

- **DO NOT clean with water, solvents, cleaning agents, bleach, or polish as these may damage the alarm.**
- VACUUM the Smoke Alarm cover *at least* once a month.
- DO NOT paint over the unit. Paint may clog the openings to the sensing chambers and prevent it from operating properly.

Carbon Monoxide (CO)

Carbon monoxide (CO) is an insidious poison. It is a colorless, odorless and tasteless gas. It can endanger lives even at low levels of concentration. Many cases of reported carbon monoxide poisoning indicate while victims are aware they are not well, they become so disoriented they are unable to save themselves by either exiting or calling for assistance. Young children and household pets may be the first affected.

CO gas is produced when any type of fuel is incompletely burned. Potential sources of CO in and around your RV can include gas or diesel engine exhaust, portable space heaters, gas stoves and ovens, furnaces, defective engine exhaust systems, portable grills, other nearby RVs, portable generators, generator exhaust, and other propane-powered appliances.

CARBON MONOXIDE (CO) POISONING may cause the following symptoms:

It is important to discuss these symptoms with ALL household members and RV guests.

- **Mild exposure:** Headaches, running nose, sore or watery eyes, often described as *flu-like* symptoms.
- **Medium exposure:** Dizziness, drowsiness, vomiting.
- **Extreme exposure:** Unconsciousness, brain damage and death.

WARNING

The Smoke Alarm does NOT operate without working batteries.

Removing the batteries, or failure to replace them at the end of their service life, removes your protection.

WARNING

Many cases of reported CARBON MONOXIDE POISONING indicate that while victims are aware they are not well, they become so disoriented they are unable to save themselves by either exiting the building or calling for assistance.

WARNING

If you are in an RV with either a nearby tow vehicle engine or generator running there is a potential for exhaust fumes to filter back into the RV.

The best protection against Carbon Monoxide entry into the RV is a properly maintained ventilation system and an active Carbon Monoxide (CO) Detector/Alarm.

To allow for proper operation of the ventilation system, keep the ventilation inlet grills clear of snow, leaves or other obstructions.



Carbon Monoxide (CO) Alarm

! WARNING

DO NOT stand close to the Alarm when the horn is sounding.

Exposure at close range may be harmful to your hearing. When testing, STEP AWAY when horn starts sounding.

! WARNING

Actuation of your CO Alarm indicates the presence of carbon monoxide (CO) which can KILL YOU.

This CO Alarm will ONLY indicate the presence of carbon monoxide gas at the sensor. Carbon monoxide gas may be present in other areas.

! WARNING

This CO Alarm does NOT operate without working batteries.

Removing the batteries, or failure to replace them at the end of their service life, removes your protection.

Carbon Monoxide (CO) Alarm

The CO alarm will sound if Carbon Monoxide (CO) in the air inside your RV reaches dangerous levels. If you hear this alarm, evacuate the RV immediately and stay outside in *fresh air* until the CO alarm ceases. It is important that you read and understand the OEM User's Manual found Owner Information Package

- **The CO alarm is designed to be loud enough to wake up a sleeping person in an emergency.**

Prolonged exposure to the CO alarm at close distance may be harmful to your hearing. Individuals with hearing loss or certain medical problems, should consider using warning devices that provide both audible and visual signals.

If the CO alarm sounds, follow these instructions:

1. **MOVE TO FRESH AIR IMMEDIATELY, either outdoors or by an open door or window.**
 - CHECK that all persons are accounted for.
 - CALL 911, your local emergency service, or fire department.
 - DO NOT re-enter the premises or move away from the open door/window until the emergency responders arrive, the premises have been aired out, *and* your alarm remains in its normal operation.
2. **If your CO alarm re-activates within a 24-hour period:**
 - REPEAT step 1.
 - CALL a qualified appliance technician to inspect that all fuel burning appliances are operating properly, and to investigate for sources of carbon monoxide.
 - IF PROBLEMS ARE IDENTIFIED during this inspection, have the equipment SERVICED IMMEDIATELY.
3. **NOTE any combustion equipment NOT inspected by the technician.**
 - For more information about CO safety and this equipment, consult the manufacturers' instructions, or contact the manufacturer directly.
4. **CONFIRM that a motor vehicle or generator engine operating nearby is NOT the source of CO inside your RV.**

A CO alarm is NOT A SUBSTITUTE for other combustible gas, fire, or smoke alarms.

Test the CO alarm weekly

TEST the CO alarm at least once EVERYWEEK to make sure that it is working properly. Stand at arm's length from the alarm when testing. **The alarm horn is loud and may be harmful to your hearing.**

PUSH and HOLD the *TEST/SILENCE* button on the cover until the red LED flashes. The alarm horn will sound *4 beeps-pause, 4 beeps-pause*. The alarm sequence should last 5-6 seconds.

If the alarm does not test properly:

1. CHECK that the battery is installed correctly.
2. INSTALL a new 9V battery & RE-TEST the CO Alarm.
3. CHECK that the CO Alarm is clean and dust-free.
4. *If it still does not alarm*, REPLACE the CO Alarm immediately.

Battery

REPLACE the battery in your CO alarm when it “chirps” about once per minute (*the low battery warning*). NEVER disconnect the battery to silence the CO alarm.

- **When the *low battery warning* sounds, the battery MUST be replaced to continue your protection.**

Maintenance

To keep the CO Alarm in good working order:

- **DO NOT clean with water, solvents, cleaning agents, bleach, or polish as these may damage the alarm.**
- VACUUM the CO Alarm cover once a month, *then* RE-TEST.
- DO NOT paint over the unit. Paint may clog the openings to the sensing chambers and prevent it from operating properly.

Propane Gas (LP) Alarm

A propane leak detection device is installed for your safety, because your new RV contains a *propane gas system* and *propane appliances*. Propane gas is heavier than air. During a leak, propane flows toward and collects in low areas. For this reason, the propane alarm is located near the floor of the RV. When the LED on the front glows green, the alarm is active.

- **Individuals with hearing loss or certain medical problems should consider using warning devices that provide both audible and visual signals**

The sensor may also detect other combustible fumes or vapors including; acetone, alcohol, butane and gasoline. These chemicals can be found in common items such as deodorant, cologne, perfume, wine, liquor, adhesive, lacquer, kerosene, most cleaning agents and the propellants of aerosol cans.

WARNING

TEST Carbon Monoxide Alarm operation: after the RV has been in storage, before each trip, and once a week while in use.

- If the CO Alarm ever fails to test correctly, have it replaced immediately!
- If the CO Alarm is NOT working properly, it *cannot* alert you to a problem.
- Failure to test units used in RV's as described may remove your protection.

The Test/Silence button is the only proper way to test the CO Alarm.

NEVER test the CO alarm with vehicle exhaust! Exhaust may cause permanent damage and voids your warranty.

WARNING

DO NOT try fixing the Alarm yourself, this will void your warranty!

If the CO Alarm is NOT operating properly, and it is still under warranty, please see “How to Obtain Warranty Service” in the Limited Warranty. Install a new CO Alarm immediately.

WARNING

DO NOT spray cleaning chemicals or insect sprays directly on or near the CO Alarm.

DO NOT paint over the CO Alarm. Doing so may cause permanent damage.

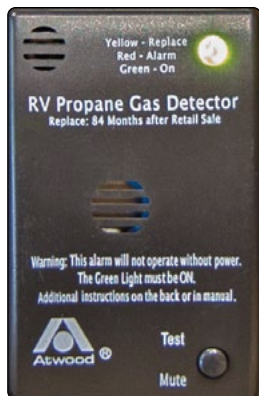

Propane Gas Alarm

! WARNING

- Activation of this device indicates the presence of LP gas, which can cause an explosion and/or fire. This normally indicates a leak in the LP gas piping or an LP gas appliance.
- If the information in the manufacturer manual is not followed exactly, a fire or explosion may result, causing property damage, personal injury or loss of life.

! WARNING

- When the alarm is first turned on, it cannot detect propane or sound a warning for two minutes.
- The propane leak alarm is not a smoke or fire alarm.
- The alarm will only indicate the presence of propane gas at the sensor.
- Explosive gas may be present in other areas.

Propane Gas (LP) Alarm, Continued

High temperatures can activate glue and adhesive vapors. If your RV is closed on a hot day, the chemicals used in its construction may be detected, even months after the vehicle was built.

See **page 39-42: Indoor Air Quality, Chemical Sensitivity & Outgassing, and Formaldehyde.**

Procedures to Take During an LP Gas Alarm:

1. **EXTINGUISH all flames and smoking material, & TURN OFF all gas appliances.**
(Stove, Heater, Furnace, Refrigerator, etc.)
 - DO NOT touch any electrical switch, or use phones / electronic devices in the RV.
2. **PRESS the Test/Mute switch to temporarily silence the alarm.**
 - DO NOT disconnect power.
3. **EVACUATE everyone from the RV.**
 - EXECUTE your Family Safety Plan.
4. **LEAVE the door(s) and windows OPEN.**
5. **SHUT OFF the gas supply at the LP tank valve.**
 - DO NOT start any vehicle engine or generator.
6. **DETERMINE & REPAIR the source of the leak.**
7. **DO NOT RE-ENTER THE RV UNTIL THE PROBLEM IS CORRECTED.**

Contact your dealer or propane gas service to have the problem corrected BEFORE using the propane system.

Testing the propane gas alarm

The propane alarm should be tested after each storage period, before each trip, and at least once per week while camping.

- **Test the propane alarm at least once per week.**
 1. Press **TEST** button until alarm sounds; then release.
 2. The detector will sound twice.
 3. The LED will turn **red**, then after 8 seconds, turn **green** again, indicating normal operation.

If the propane alarm does not test properly, replace it immediately.

Battery or converter power source

The propane gas alarm runs on a small amount of 12-volt DC from the converter or auxiliary battery. This slight current draw can still drain your auxiliary battery during an extended storage period. The Low Voltage Warning will sound if the charge drops below 8 volts. ***At lower voltage the alarm will no longer detect gas or provide protection against dangerous levels of LP.***

Indoor Air Quality

To maintain indoor air quality:

- **Allow your RV proper ventilation.**
- **Keep the interior clean.**
- **Avoid harmful air pollutants.**

Common air pollution sources include molds, pollen, pet dander, cigarette smoke, household cleaners and carbon monoxide from burning propane, charcoal or other fuels.

- **Proper Ventilation** carries air pollutants outside your RV, and dilutes emissions from indoor sources with fresh air from the outdoors.
- **Poor Ventilation** may increase pollutant levels inside your RV. High temperature and humidity levels can also increase the concentration of some indoor air pollutants.
- **Those most at risk for REACTIONS to poor air quality include: Children, The Elderly, and Persons with Asthma, Allergies, Heart Disease, or Chronic Lung Diseases such as Bronchitis and Emphysema.**

To improve your air quality:

- BREATHE ***fresh air*** by opening windows.
- Spend as much time as you can OUTSIDE in ***fresh air***.
- **CONTROL MOLD:**
 - CLEAN the bathroom and kitchen often.
 - FIX any water leaks.
 - CLOSE windows and RUN your air conditioner (AC) and/or your dehumidifier.
 - CLEAN any mold you see or smell with a solution of One Cup of BLEACH *or less*, to One Gallon of WATER.
 - NEVER mix bleach with ammonia.

Indoor Air Quality, Continued

- CLEAN & VACUUM often to get rid of dust and pet fur which can irritate your nose and throat.
- DO NOT use bug spray inside your trailer.
- DO NOT smoke inside your RV. In addition to causing damage to your RV, tobacco smoke releases formaldehyde and other air pollutants.

EPA recommendations

The Environmental Protection Agency (EPA) recommends three (3) basic strategies to improve indoor air quality:

1. **Remove sources.** Eliminating the sources of pollution or reducing their emissions are the most effective ways to improve indoor air quality. This strategy can have an impact on the following pollutants:
 - Biological Contaminants such as bacteria, molds, mildew, viruses, animal dander, and pollen.
 - Household Products such as paints, varnishes, cleaning and disinfecting solutions, cosmetics and hobby products.
 - Pesticides.
 2. **Ventilation.** Increasing the amount of outside air coming inside helps to lower the concentration of indoor pollutants. Allow fresh air to circulate your RV often. OPEN the doors, windows, and exhaust vents. Operating fans, vent fans, and the roof air conditioner(s) or furnace also helps to bring in *fresh air* and force out *stale air*.
 - Keeping your RV closed, decreases the air flow, which increases the presence of indoor air pollutants.
 - Many recommendations in this manual can assist you in avoiding exposure to indoor air pollutants and outgassed chemicals.
- See the **Next Page**, Chemical Sensitivity & Outgassing. See **page 43**, Tips to controlling condensation.*
3. **Air Cleaners.** Air cleaners are designed to remove particles from the air. Their effectiveness depends on how well they collect pollutants from indoor air, and how much air is drawn through the cleaning/filtering element. An effective air cleaner requires both an efficient collector and a high air-circulation rate.



Chemical outgassing is NOT a defect in your RV.

It is NOT covered by the Limited Base or Limited Structural Warranties.

Please follow the recommendations in this section to address the concern.

There are many sizes and types of air cleaners on the market. Most of the less expensive, table-top models, are much less effective at particle removal. Generally, air cleaners DO NOT remove gaseous pollutants.

Chemical Sensitivity & Outgassing

When you first purchase your new RV, or after it has been closed for an extended time, you may notice a chemical odor due to outgassing. This is normal, and not a defect.

Outgassing (or *offgassing*) is the release of a chemical gas that was dissolved, trapped, frozen or absorbed in a material. The amounts released through outgassing decrease over time.

Just like in your home, RV construction uses many products such as carpet, linoleum, plywood, insulation, upholstery, etc. These new products may outgas different chemicals, including formaldehyde. This can continue over time, and in particular, when exposed to elevated temperatures or humidity.

Because RVs are smaller than a home, the exchange of air inside your RV is much less. The minimal air exchange, can make any outgassed chemicals more noticeable.

Chemical sensitivity may cause you to experience irritation of the eyes, nose, and throat and sometimes nausea, headache, and a variety of asthma-like symptoms. Elderly persons, young children, or anyone with a history of asthma, allergies or lung problems, may be more susceptible to the effects of outgassing.

Formaldehyde

Most of the attention regarding chemical outgassing surrounds formaldehyde. Some people are very sensitive to formaldehyde exposure while others may have no reaction.

Formaldehyde is a naturally occurring substance. It is a key industrial chemical used in the manufacture of numerous consumer goods including products used in RV construction. Trace levels of formaldehyde are also released from smoking, cooking, and the use of many other household products like detergents, cleaners, paints, coatings and cosmetics.



If you have any questions regarding the health effects of formaldehyde or any other air pollutants, consult your doctor or local health department.

Formaldehyde, Continued

California Air Resource Board (CARB) Notice

Formaldehyde is used widely in building materials such as pressed wood products, particleboard, hardwood plywood paneling, medium density fiberboard (MDF), and plywood which are commonly used throughout the Recreational Vehicle Industry. As mandated by the RV Industry, Grand Design RV recreation vehicles contain composite wood products (hardwood plywood, particle board, and MDF) that comply with the California Air Resource Board (CARB) formaldehyde emission standards under California Code of Regulations § 93120.2(a) Phase 2 (P2).

Effects Of Prolonged Occupancy

- **If you plan to occupy your RV for an extended period, be prepared to deal with condensation and the humid conditions that may be encountered.**

Your RV is designed primarily for recreational and extended stay use. Modern RVs have a relatively small volume due to their compact construction. The normal living activities of even a few occupants in the RV, can lead to rapid moisture saturation of the air inside and the appearance of visible moisture, especially in cold weather.

Condensation

Condensation refers to the water droplets that appear on cold surfaces when the water vapor in the air cools, and changes to liquid water. In cold weather, it may be seen as frost or ice.

- *Moisture can condense on the inside of an RV during cold weather the same way that moisture collects on the outside of a cold glass during humid weather.*

Condensation may also collect out of sight within the walls or ceiling, causing warped or stained panels. Appearance of these conditions may indicate a serious condensation problem. To minimize condensation inside your RV, moisture in the air must be carried outside by ventilation, or removed with a dehumidifier (customer supplied).

Tips for controlling condensation

To reduce moisture in the air inside your RV, use these tips:

- Allow excess moisture to escape to the outside when bathing, washing dishes, hair drying, laundering and using appliances and non-vented gas burners.
- Keep the bathroom door closed, roof vent opened and turn on the exhaust fan (if equipped) while bathing or showering and for some time after you have finished.
- When cooking, always operate the range hood fan. Cooking releases heat and moisture that can quickly result in condensation in your RV; operating the range hood fan can be effective in removing both.
- DO NOT hang wet clothes in the RV to dry.
- Use a fan to keep air circulating inside the vehicle so condensation and mildew cannot form in dead air spaces.
- Allow air to circulate, keeping the temperature the same throughout the RV, even inside the cabinets.
 - Leave closet and cabinet doors partially open.
 - A closed cabinet full of stored goods will prevent circulation and can cause condensation.

In hot weather

- Start the air conditioner early in the day to remove excess humidity from the air while lowering the temperature.

In cold weather

- During cold weather it is very important to continue utilizing your vents and vent fans. This will keep the humid air inside moving to the outside. Keeping the RV tightly closed during cold weather will increase condensation.
- Manage the inside temperature during cold weather. The warmer temperatures inside your RV will cause condensation to form on areas that are not well insulated (ie., windows, vents, wall studs, etc.).



If the tips presented here for controlling condensation are NOT effective, it may be necessary for you to invest in a dehumidifier to reduce the health risk to you or your family, as well as prevent damage to your RV.

Where There Is Moisture, There May Be Mold

Molds are microscopic organisms that occur in virtually any indoor and outdoor environment. Mold growth requires a source of moisture (ie., high humidity, wet/damp materials, standing water) and a temperature between 40° and 100° Fahrenheit.

According to the Center for Disease Control, exposure to damp and moldy environments may cause a variety of health defects, or none at all.

- For people *sensitive* to molds, mold exposure may cause nasal congestion, coughing, wheezing, and/or irritation of the eyes, throat, or skin.
- People with *mold allergies* may have more severe reactions to mold exposure. Immune-compromised people and those with chronic lung illnesses, like obstructive lung disease, risk serious lung infections.

Mold growth can be very harmful to the natural wood products and fabrics in your RV. **Follow these tips to help control the relative humidity inside your RV and inhibit mold and mildew:**

- While cooking and bathing, **ALWAYS** use the kitchen and bathroom vents, even during colder weather.
- In addition, opening a window will increase ventilation during these activities.
- Running your air conditioner will also reduce the relative humidity.
- In extremely humid conditions, using a dehumidifier (customer supplied) can be helpful.

Mold Prevention

To help protect your RV from mold, follow these important preventative measures:

- Clean regularly, especially the kitchen and bathroom. On safe surfaces, use cleaning products that kill mold and mildew.
- Any spills should be wiped up and dried right away.
- DO NOT leave any damp items inside the RV.
- Check sealants regularly. Reseal as needed to avoid water leaks.

Cold Weather Use

Please keep in mind, that your RV is not designed for use during sub-freezing weather. If you plan to use your RV in freezing (or below freezing) temperatures, the following precautions **MUST** be taken:

- The **Water Heater, Plumbing Systems** and **drainage** require added protection to avoid freezing.
- More frequent furnace operation substantially increases battery draw and propane use.
 - Sufficient power and propane are required to protect against possible freeze-ups of the propane regulator.
- Proper ventilation or the addition of a dehumidifier may be required to reduce condensation.
- To avoid damage to parts, **CHECK** the outside of the RV for ice **BEFORE** operating the: slide outs, compartment doors, locks, windows, vents etc.

If you have further questions, please contact your dealer or Grand Design RV Customer Service.

Websites Of Interest

We also recommend that you visit the following websites that maintain information about indoor air pollutants, including molds and formaldehyde, along with ways to improve indoor air quality:

- www.epa.gov/indoor-air-quality-iaq/inside-story-guide-indoor-air-quality
- www.epa.gov/mold
- www.atsdr.cdc.gov

Website Usage Disclaimers

Grand Design RV hereby disclaims and sets forth as follows:

Website disclaimer of warranty

The services, information and materials on websites listed in this manual are provided "AS IS" and Grand Design RV shall have absolutely no liability whatsoever in connection with these website services, information, external links or third party links on these websites. Your use of these websites are at your own risk. Grand Design RV shall have no liability whatsoever for any errors, omissions or inaccuracies in the information regardless of how caused or for delays or interruptions in delivery of the information: or any decision made or action taken or not taken in reliance upon the information furnished.

Grand Design RV accepts no responsibility or liability whatsoever with regard to information on these websites as the information is meant to be of a general nature only and is not intended to address the specific circumstances of any particular individual or entity.

The information provided is not necessarily comprehensive, complete, accurate or up to date; the information is sometimes linked to external sites over which Grand Design RV has no control and for which Grand Design RV assumes no responsibility: Grand Design RV shall have no liability for any loss or injury caused, in whole or in part, by its actions, omissions or negligence, or for any contingencies beyond its control in procuring, compiling or delivering any information. The information is not professional nor does it comprise legal advice. (If you need specific advice, you should always consult a suitably qualified professional.)

Disclaimer of endorsement

Any reference within external or third party links to any specific commercial products, process or service by trade name, trademark, manufacturer or otherwise, does not constitute or imply its endorsement, recommendation or favoring by Grand Design RV. The appearance of external or third party links does not constitute endorsement by Grand Design RV of the linked web sites or the information, products or services contained therein.

Grand Design RV does not exercise any editorial control over the information you may find at these locations. External or third party links may be provided for the convenience of the users of that website. Grand Design RV is not responsible for the availability or content of these external or third party sites and does not endorse, warrant or guarantee any products, services, information, centers or schools described or offered at these links.

Additional Safety Precautions

Air Quality

Proper ventilation of your RV is required to maintain air quality. Breathing and daily activities like cooking and bathing, add moisture to the air. This moisture can become condensation.

- Condensation inside your RV indicates that proper ventilation is NOT occurring.
- Condensation can lead to mold growth.
- Proper ventilation helps remove formaldehyde which is contained in some building materials as well as a by-product of combustion.

Generators

- **Your RV is designed to use ONLY generators built specifically for RVs.**

Generator /Vehicle Exhaust

ONLY operate a generator (customer supplied) in an open outdoor area where the exhaust can dissipate.

- To avoid the dangers of carbon monoxide, prevent exhaust gases from entering your RV.
- Close all entry/compartments doors, and windows near vehicle or generator exhaust.

Additional Safety Precautions, Continued

Loading & Weight Distribution

- Distribute cargo weight evenly throughout your vehicle.
- NEVER exceed your RV's *Cargo Carrying Capacity* or *Gross Vehicle Weight Rating*.
- Place heavy items in the center of your vehicle, on the floor.
- Balance loads *front-to-rear* and *side-to-side*.

Passenger Safety

- **DO NOT allow anyone to ride inside as a passenger while your RV is in motion.**
- This practice is *against the law* in several states.

Propane Appliances & Equipment

- Turn OFF all propane appliances and equipment (including the tanks) are BEFORE departing on a trip.
- Understand all propane safety warnings and follow manufacturer recommended operating procedures.
- **Propane gas is flammable, improper use may result in a fire or explosion.**

Tire Pressure

- ALWAYS check tire pressure BEFORE departing on any trip, even a short distance. For proper tire inflation pressures, refer to the *Tire Information Label*.

Towing

High cross winds and the external forces created by large trucks as they pass, may cause *swaying* or *fishtailing*. This can lead to a loss of control, resulting in serious injury or death. Under these conditions, slow down and pay close attention to other vehicles.

- ALWAYS follow posted speed limits, *and*
- Adjust for weather or road conditions that can impact the stability/handling of your tow vehicle and RV.

Wheel Torque

- ALWAYS check the torque on *all* lug nuts BEFORE departing on any trip, even a short distance.
- For lug nut torque specifications and patterns, refer to the Tire & Wheel section of this manual.
- ALWAYS use a calibrated torque wrench to confirm proper torque.

Pre-Travel Information

To help ensure your traveling enjoyment, update your GPS (customer supplied) and confirm that your route is planned with current road maps. Call ahead for tourist information for the areas that you will be visiting or traveling through. Research that your planned camping adventures comply with all federal, state and local regulations.

- Arrange for someone to check your house periodically while you are away. Stop mail or newspaper delivery.
- If you intend to be away for more than two weeks, you may want to consider requesting police surveillance for your house.
- Carry an extra set of vehicle and house keys with you on a separate key ring.
- Check that your driver's license is valid. Be sure to renew your license in advance if it will expire during your trip.
- If you are planning to visit other countries, contact the consulate nearest the point at which you plan to enter that country for the specific and most current information (including rules for re-entering the United States).

Always carry your vehicle registration, insurance policy card(s) and warranty registration.

Tow Vehicle Disclaimer

- **As a *minimum* requirement, your tow vehicle's *Towing Capacity MUST BE GREATER THAN* the *Gross Vehicle Weight Rating (GVWR)* of your RV.**

Contact your automotive dealer to confirm the towing capacity of your vehicle, whether you are buying a new tow vehicle, or will tow your RV with one that you already own. Discuss the GVWR, size and type of RV that you will be towing. If you plan to purchase a new vehicle, some trucks can be purchased with an optional tow package.

Some automotive manufacturers publish brochures that discuss towing considerations. Ask your automotive dealer how to obtain a copy of this information. Verify that the weight ratings listed in the brochure are for your exact vehicle, ie, the correct year, model, engine, transmission, suspension and any relevant options.

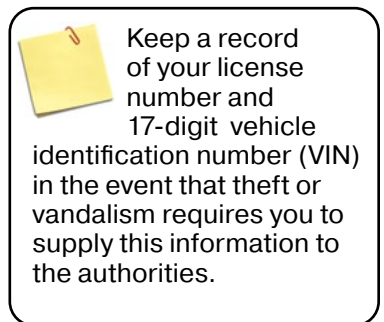

Vehicle Labels

Decals and data plates used throughout the RV aid in its safe and efficient operation; others give service instructions. Read all decals, data and instruction plates before operating your RV. If any decal, data or instruction plate is painted over, damaged or removed, it should be replaced.

Weight Ratings & Definitions

It is essential to understand and stay within the weight ratings of your RV and tow vehicle. Learning these definitions is the first step in safely managing your RV's weight and balance. Vehicle and trailer weight numbers fall into two categories:

- **Ratings** are maximum limits, NEVER to be exceeded. These limits are established by Grand Design RV and our component manufacturers in the design of the vehicle.
- **Weight** and **Load** are often used interchangeably. Weight is measured by putting an RV, tow vehicle or its components on a scale. Vehicles and cargo have *weight*, which impart *loads* to tires, axles, and hitches.

GAWR (Gross Axle Weight Rating) - GAWR is the maximum weight each axle is designed to carry.

GVWR (Gross Vehicle Weight Rating) - GVWR (also called *Maximum Loaded Trailer Weight*) includes the GAWR *plus* the hitch weight. It is the maximum allowed weight for a fully loaded RV or tow vehicle.

Gross (Trailer/Vehicle) Weight - Gross Weight is the total actual weight of your RV *plus* cargo, as measured on a scale.

UVW (Unloaded Vehicle Weight) - UVW is the weight of the RV as built at the factory. The UVW includes the empty LP bottles but does NOT include cargo, water, LP gas, or dealer-installed accessories.

Hitch Weight (or *Tongue Weight*) - is the amount of weight that presses down on the hitch when an RV is connected to a vehicle.

CCC (Cargo Carrying Capacity)

- **United States:** CCC is equal to GVWR *minus* the following: UVW and LP gas weight. *Water is considered cargo weight.*
- **Canada:** CCC is equal to GVWR *minus* the following: UVW, LP gas weight, and full fresh (*potable*) water weight (*including the water heater*).

For additional definitions, See **page 167, Glossary**

WARNING

Exceeding a rating may result in unsafe conditions, potential damage, may void a warranty, may complicate an insurance claim, and in some cases, may violate a law.

WARNING

The actual total weight of the vehicle, all options, liquids, your personal cargo, and the hitch weight **is important to know** so that you **DO NOT exceed** the Gross Vehicle Weight Rating (GVWR) of the RV.

The volume of space available for storage **may exceed the amount of available Cargo Capacity.**

Large storage compartments have been designed to accommodate normal camping items, which are bulky, but not necessarily heavy.

Weight Labels

Vehicle weight labels are affixed to your RV to help you make an informed decision before your purchase. **DO NOT REMOVE THESE LABELS.** If the labels are missing, contact your dealer or Grand Design RV Customer Service for replacements.

Federal Certification Label

This label specifies the maximum capacities for GVWR, GAWR and tires. It is located on the forward, off-door-side exterior.

MANUFACTURED BY/FABRIQUE PAR: Grand Design RV, LLC	DATE: 01/2013
GVWR/PNBV 7264 KG(16000 LB)	
GAWR(EACH AXLE)/PNBE (CHAQUE ESSIEU) 3178 KG(7000 LB)	
TIRES/PNEU ST235/80R16 RIMS/IANTE 16x6 8-6.5	
COLD INFL. PRESS./PRESS. DE GONFL. A FROID 552 KPA(80 PSI/LPC)	SINGLE

THIS VEHICLE CONFORMS TO ALL APPLICABLE U.S. FEDERAL MOTOR VEHICLE SAFETY STANDARDS IN EFFECT ON THE DATE OF MANUFACTURE SHOWN ABOVE. THIS VEHICLE CONFORMS TO ALL APPLICABLE STANDARDS PRESCRIBED UNDER THE CANADIAN MOTOR VEHICLE SAFETY REGULATIONS IN EFFECT ON THE DATE OF MANUFACTURE. - CE VEHICULE EST CONFORME A TOUTES LES NORMES QUI LUI SONT APPLICABLES EN VERTU DU REGLEMENT SUR LA SECURITE DES VEHICULES AUTOMOBILES DU CANADA EN VIGUEUR A LA DATE DE SA FABRICATION.

V.I.N./N.I.V.: 573FS3821D1100001 TYPE/TYPE: TRAILER TRA/REM Solitude Fifth-Wheel

Tire and Loading Information Label

This label specifies the tire size information, recommended cold tire pressure, and the maximum amount of cargo that can be safely added to the RV. It is located on the forward, off-door-side exterior.



TIRE AND LOADING INFORMATION
RENSEIGNEMENTS SUR LES PNEUS ET LE CHARGEMENT

The weight of cargo should never exceed 1360 KG or 2998 LBS. Le poids de chargement ne devrait jamais excéder 1360 KG ou 2998 LBS.

TIRE PNEU	SIZE DIMENSIONS	COLD TIRE PRESSURE PRESSION DES PNEUS A FROID	SEE OWNER'S MANUAL FOR ADDITIONAL INFORMATION VOIR LE MANUEL DE L'USAGER POUR PLUS DE RENSEIGNEMENTS
FRONT AVANT	ST235/80R16 LRE	552 KPA /80 PSI	
REAR ARRIERE	ST235/80R16 LRE	552 KPA /80 PSI	
SPARE DE SECOURS	ST235/80R16 LRE	552 KPA /80 PSI	

573FS3821D1100001

Cargo Carrying Capacity (CCC) Label

This label specifies the maximum cargo carrying capacity for your RV. It is located on the side edge of your *Main Entry Door*.

RECREATION VEHICLE TRAILER CARGO CARRYING CAPACITY
VIN: 573FS3821D1100001
THE WEIGHT OF CARGO SHOULD NEVER EXCEED
1135 kg or 2500 lbs.
CAUTION:
A full load of water equals 188 kg or 415 lbs of cargo @ 1 kg/L (8.3 lb/gal)

RV Length Label

This label specifies the overall length of your recreational vehicle. It is located with the Cargo Carrying Capacity (CCC) label on the side edge of your *Main Entry Door*.

Recreational vehicle overall length _____ as manufactured.

For Travel Trailers -

The length as measured from the leading front edge of the hitch coupler to the rear most extremity of the trailer, bumper or rear wall / rear cap *if not equipped or installed with a bumper*.

For Fifth Wheel Trailers -

The length as measured from the leading front edge of the pin box or extreme front of the front profile, whichever is further forward, to the rear most extremity of the trailer, bumper or rear wall / rear cap *if not equipped or installed with a bumper*.

Recreational vehicle overall length **excludes** some RV accessories as defined by Grand Design RV, including but not limited to:

- Safety-Related Equipment, (*Signal, Clearance, or Identification Lamps; Warning Lights; Appliance Vents & Vent Hoods*).
- Door Latches *and* Hinges.
- Entry *and* Exit Handholds.
- Exterior Ladders.
- Spare Tires *and* Spare Tire Brackets / Carriers.
- Bumper mount Outside Cooking Appliances.
- Hitch *or* Cargo Accessory Receivers, *and*
- Equipment used to secure cargo.

Cargo Capacities

When loading cargo into your RV, **DO NOT exceed**:

- Maximum weight specified on the Cargo Carrying Capacity label
- GVWR (Gross Vehicle Weight Rating)
- *Maximum Load Rating* of your RV tires.

The Maximum Load Rating of your RV tires is **LESS THAN** the GVWR. To calculate the actual weight on your RV tires, subtract the hitch weight from your RV's Gross Weight. The hitch weight is carried by your tow vehicle, not the RV tires.

For example:

- if your RV's tires are each rated at 2,000 lbs.
2,000 lbs. x 4 tires = 8,000 lbs.
- Gross Weight is 9,000 lbs.
- with a hitch weight of 1,200 lbs., *then*
9,000 lbs. - 1,200 lbs. = 7,800 lbs.

The *actual weight* on the RV tires is 7,800 lbs., This is under the load rating of the tires.

- **7,800 lbs. ÷ 4 tires = 1,950 lbs. each**

Water and Propane

- Your FRESH WATER is treated as *CARGO WEIGHT*.
- Water weighs roughly 8.34 lbs. per gallon.
 - 50 gallons of water weighs 417 lbs.

If you are close to your GVWR, **reducing** the amount of water in the holding tank will **increase** the amount of available cargo weight by the same amount. This flexibility allows you to make choices that fit your travel and camping needs.

Remember:

- Unloaded Vehicle Weight is calculated with empty LP bottles.
- Cargo Carrying Capacity is calculated including the weight of full LP bottles. **CCC = GVWR - (UVW - LP gas weight)**

If you have further questions, please contact your dealer or Grand Design RV Customer Service.

WARNING

The load capacity of your RV is designated by weight, not by volume. All available storage space cannot necessarily be used when loading the RV.

For the best possible handling:

- DO NOT exceed your GVWR.
- Ensure you are loading the vehicle evenly.
- To prevent shifting during travel, secure heavy items.

 **WARNING**

ONLY store items in the areas designated for storage.
DO NOT store anything in the areas reserved for the furnace, water heater, converter, or electrical panels, etc.

 **WARNING**

NEVER load the RV in excess of the GAWR for either axle.
Overloading the RV may result in adverse handling characteristics & damage to the chassis.

 **WARNING**

DO NOT EXCEED YOUR GVWR! This means you should weigh your RV as loaded for your normal travel to determine the actual weight.

If you exceed the GVWR, you MUST remove items from the RV, or drain liquids, then re-weigh the RV to ensure you have achieved a safe weight.

DO NOT travel with full grey/black holding tanks. This not only wastes gas but, depending upon the location of the grey or black holding tanks, can affect handling characteristics.

Loading Your RV

Evenly distribute your cargo **side-to-side** for safe travel.

- The weight on each tire **must not exceed** one-half of the GAWR (Gross Axle Weight Rating) for either axle.

DURING A SUDDEN STOP, free-standing furniture or overlooked items on the counter top/range can become dangerous projectiles.

- It is important to secure the appliance or furniture tie down straps (if so equipped).
- STORE and SECURE all LOOSE ITEMS inside your RV. Check that all items are safely put away BEFORE travel. (*ie., canned goods, pots & pans, small appliances, etc.*)

Weighing Your Tow Vehicle & RV

- **TOTAL WEIGHT** and **BALANCE** are the two most important factors when loading your RV.
- ALWAYS verify that your loaded RV is in compliance with all applicable weight ratings.

Weigh your RV at a public scale to confirm that your loaded RV complies with all vehicle, tire and axle weight ratings. This will also help you to determine the proper load distribution.

- The area around the scale **must** allow for weighing each side of your RV.
- Individual scales may operate differently.

Traveling while your RV is OVERLOADED or with a load that is UNBALANCED:

- Will ADVERSELY AFFECT your tow vehicle's HANDLING
- Can cause COMPONENT FAILURE

OVERLOADING your RV will VOID:

- The Limited Base Warranty
- The Limited Structural Warranty, and the
- Manufacturer warranties of many component parts.

To weigh your *Tow Vehicle and RV*

BEFORE you begin, read through all the weighing instructions. Your RV must be weighed FULLY LOADED (*ie., with food, water, clothing, supplies, propane, fuel, etc.*).

1. Weigh your RV while **unhitched** from the tow vehicle to obtain your *Gross Vehicle Weight* (GVW).
 - **FOR SAFE OPERATION:** Your RV's GVW **must** be *LESS THAN* or *EQUAL* to the GVWR.
 - **If your RV's weight is GREATER THAN the GVWR,** then you **must** REMOVE contents until the weight is in compliance with your RV's listed ratings.

2. Hitch your RV to the tow vehicle. Weigh the RV and tow vehicle to obtain your *Gross Combined Weight* (GCW).
 - Confirm that **your GCW** is *LESS THAN, or EQUAL* to the *Gross Combined Weight Rating* (GCWR) specified by the manufacturer of your tow vehicle.
 - **If your GCW is GREATER THAN the GCWR,** REMOVE contents until the weight is in compliance.

3. *While still hitched to the tow vehicle,* PULL onto the scale to weigh **ONLY the RV**, and RECORD the weight. *This measures the total load carried by the RV tires.*
 - The difference of this weight, subtracted from the GVW is your *Hitch Weight*.

4. To obtain the side-to-side weights, there **must** be enough space on either side of the scale to accommodate the RV being partially off the scale.
 - Pull the RV so that the tires of **only one side** are on the scale. Your RV **must** remain as level as possible.
 - **For a BALANCED load:** The weight of one side of your RV, **must** be *EQUAL TO one half* of the weight determined in step #3.
 - **If the weight of one side of the RV is NOT EQUAL to one half of the weight from step #3,** Then you **must** REDISTRIBUTE the load until the RV is equally balanced side-to-side.

When a load is **unbalanced**, the components on the heavier side (*tires, wheels, brakes, springs, etc.*) may be **overloaded**, even though the total axle load is within the GAWR.

If you have further questions, consult with your dealer or the scale operator.

WARNING

Exceeding the established weight ratings for the axles, running gear, tires and wheels can lead to failure that can affect motor vehicle safety and lead to property damage or damage to the RV.

WARNING

Total weight of your tow vehicle and RV must not exceed the GCWR.

DO NOT assume that you can tow an RV that happens to be within the capacity of the tow vehicle hitch.

By doing so, you may exceed the total GCWR of your tow vehicle and RV towing combination.

WARNING

It is important to redistribute the load to avoid component failure as well as to improve the handling characteristics of the vehicle.



Tire Safety Information

This portion of the Owner's Manual contains tire safety information as required by 49 CFR 575.6(4) and is based in part on the National Highway Traffic Safety Administration's (NHTSA) brochure titled *Tire Safety, Everything Rides On It*.

It is available as a free download on the NHTSA website:

<https://one.nhtsa.gov/Vehicle-Safety/Tires/Tire-Safety:-Everything-Rides-On-It>

Studies of tire safety show that the most important things you can do to avoid tire failure, blowouts and flat tires are:

- MAINTAIN proper tire pressure.
- OBSERVE tire and vehicle *Load Limits*.
 - NEVER carry more weight in your vehicle than your tires or vehicle can safely handle.
- AVOID road hazards.
- DRIVE within the designated tire speed ratings,
- INSPECT tires for cuts, slashes, and other irregularities.

These actions, along with other care and maintenance activities, can also:

- Improve vehicle handling.
- Help protect you and others from avoidable breakdowns and accidents.
- Improve fuel economy.
- Increase the life of your tires.

Make tire safety a regular part of your vehicle maintenance routine. Know that the time you spend is minimal compared with the inconvenience and safety consequences of a flat tire or other tire failure.

Safety First - Basic Tire Maintenance

Proper tire maintenance improves the stopping distance, traction, steering, and load-carrying capability of your vehicle. As mentioned above, to prevent flat tires and other types of tire failure, you should maintain proper tire pressure, observe tire and vehicle load limits, avoid road hazards, and regularly inspect your tires. See **page 60**, *Tire Safety Tips*.

Maximum Load Rating

The *Maximum Load Rating* indicates the maximum load in kilograms and pounds that can be carried by the tire.

Maximum Permissible Inflation Pressure

This number is the greatest amount of air pressure that should ever be put in the tire under normal driving conditions.

Recommended Tire Pressure & Load Limits

UNDER-INFLATED TIRES and OVERLOADED VEHICLES are the major causes of TIRE FAILURE. Tire information placards and vehicle certification labels provide important information on tires and load limits, *including*:

- Recommended Tire Size
- Recommended Tire Inflation Pressure
- Cargo Weight
(the *maximum* cargo weight the RV is designed to carry)
- Front and Rear Gross Axle Weight Ratings (GAWR)
(the *maximum* weight the axle system is designed to carry)

For the label locations and more detailed information, See **page 51**, *Weight Labels*.

Understanding Tire Pressure & Load Limits

Load Limits are determined by the tire size and the greatest amount of weight each tire can safely carry.

Tire Pressure is the amount of air pressure a tire requires to be properly inflated. It is measured in pounds per square inch (PSI). Tire pressure affects your RV's overall performance and provides the load-carrying capacity.

On the *Tire and Loading Information Label*, the proper tire pressure for your vehicle is listed as **Cold Tire Pressure**. You will find this number expressed in both PSI and kilo-pascals (KPA), the metric measurement used internationally.

It is difficult to obtain the recommended tire pressure when the tires are not cold.

See the **next page**, *Checking Tire Pressure*.



Because tires are designed to be used on more than one type of vehicle, tire manufacturers list the "maximum permissible inflation pressure" on the tire sidewall. This number is the greatest amount of air pressure that should ever be put in the tire under normal driving conditions.

 **WARNING**

Always check tire pressure when tires are cold. Cold tire inflation pressure is defined as a tire that has not been used for three or more hours, or has been driven less than one mile.

Tire inflation pressure of a hot tire may show an increase as much as 6 PSI over a cold tire. **DO NOT exceed the maximum recommended pressure.**

Checking Tire Pressure

It is important to check the cold inflation pressure of your RV's tires at least once per month for the following reasons:

- Most tires will lose air naturally over time.
- Tires can lose air suddenly by driving over a pothole, hitting road debris, or striking the curb when parking.
- With radial tires, it is usually not possible to determine under-inflation by visual inspection.

For safety and convenience, purchase a Tire Pressure Gauge to keep in your vehicle. They are sold at auto parts stores, hardware stores and many other retail outlets.

Steps for maintaining proper tire pressure

1. The recommended cold inflation pressure, is listed on the *Tire and Loading Information label* located on the off-door-side, forward exterior of your RV.
2. Use a *Tire Pressure Gauge* (customer supplied), to check the tire pressure of all tires.
 - a. If the tire pressure is *TOO HIGH* in any of the tires, gently press on the tire valve stem with the edge of your tire gauge. Slowly release air until the correct pressure is reached.
 - b. If the tire pressure is *TOO LOW* in any of the tires, this can be a serious **safety hazard**. Add air to any *UNDER*-inflated tire as-soon-as possible.
3. At a service station or using a portable air compressor, **ADD** air to each under-inflated tire until the correct cold inflation pressure is reached. **DO NOT over-inflate.**
4. **Re-check** the RV tires with the *Tire Pressure Gauge*. Confirm that all four (4) tires are at the same recommended cold inflation pressure. **Adjust** as needed.

*While it is ideal to check and fill tires when they are cold, **if you discover an RV tire that is UNDER-inflated, even after you have been driving & the tires are warm:***

- **ADD** air until the *recommended cold inflation pressure* is reached.
- The warm tire may remain *slightly* under-inflated, but this is much safer than driving with a *significantly* under-inflated tire. **This fix is ONLY temporary.**
- **REMEMBER to re-check & adjust** the tire pressure as-soon-as a cold reading can be obtained.

How Overloading Affects Your RV & Tires

- **OVERLOADING** your RV can have serious consequences for passenger safety.
- An **OVERLOADED** vehicle is **hard to DRIVE** and **hard to STOP**.

Too much weight on your vehicle's suspension system can cause spring, shock absorber, or brake failure. It can also result in, handling or steering problems, irregular tire wear, tire failure, or other damage.

- In cases of serious overloading, **brakes can FAIL completely**, particularly on a steep grade.

Tire overloading caused by an excessive load and/or tire **UNDER**-inflation results in abnormal tire flexing. *This can generate an excessive amount of heat within the tire.*

- **EXCESSIVE HEAT MAY LEAD TO TIRE FAILURE.**
- **PROPER INFLATION IS CRITICAL.** It is the air pressure that enables a tire to support the load.

The load a tire can safely carry is established by a combination of the tire size, the load range, and corresponding inflation pressure. The required air pressure for your RV tires **must** be determined from your actual load (*by weighing the RV*) and taken from the *Load and Inflation Tables* provided on the tire manufacturer's website.

- These air pressures may differ from those found on the certification label.
- RV weight or tire pressure should **never exceed** the tire's *Maximum Load Rating* or maximum air pressure.
- **If you discover that your tires cannot support the actual weights**, REMOVE contents until the RV's weight is in compliance.

Steps for determining correct load limit

1. Locate the statement "The weight of cargo should **never exceed** XXX KG or XXX LBS" on your RV's Cargo Carrying Capacity label.
 2. This figure equals the amount of **available load capacity** for cargo and luggage.
- **The combined weight of cargo and luggage loaded on your RV must not exceed the available load capacity.**

DANGER

If the total weight of the RV exceeds the GVWR, the trailer is overloaded.

Operating your RV while exceeding the specified weight ratings increases the risk of a crash, personal injury and death.

It is necessary to remove payload (equipment, water, personal belongings, etc.) until the total weight of the RV no longer exceeds the GVWR before operating the RV.

DANGER

If the weight on the trailer axles exceeds the GAWR, the axles are overloaded. Operating your RV while exceeding the specified weight ratings increases the risk of a crash, personal injury and death.

It is necessary to remove or rearrange payload (equipment, personal belongings, water, etc.) until the axle weight no longer exceeds the GAWR before operating the unit. Not operating your RV within the designed weight ratings can damage your recreational vehicle which is not covered under warranty.

Tire Safety Tips

Preventing tire damage

- DO NOT run over curbs or foreign objects in the roadway or when parking.
- *SLOW WAY DOWN* if you can not avoid a pothole or other object in the road.

Tire safety checklist

1. CHECK tire pressure *at least* monthly, including the spare.
2. INSPECT tires for uneven wear patterns on the tread, cracks, foreign objects, or any other damage.
3. *Carefully* REMOVE bits of glass or foreign objects wedged in the tread.
4. CHECK that all tire valves have valve caps.
5. CHECK tire pressure before going on any trip.
6. **DO NOT overload your vehicle.**
 - FOLLOW the instructions for cargo and cold tire pressure found on your *Tire and Loading Information* label.

Tire Labeling

Federal law requires that tire manufacturers provide standardized information molded into the sidewall of all tires sold in the U.S. This includes the tire's size, construction, various capacities (max. pressure, load, speed) and the *Tire Identification Number*.

US DOT Tire Identification Number (TIN)

The *Tire Identification Number* is provided for safety standard certification and in the event of a recall. More than just a serial number, this code identifies the specific production run of a tire.

- The **TIN** always begins with "DOT" usually followed by 10-12 numbers, letters, or symbols.
- The *first* two (2) numbers or letters following DOT, are the **plant code** where the tire was manufactured.
- The *last* four (4) numbers show the **week** and **year** the tire was built. **For example:**
 - **3119 = the 31st week of 2019.**
- The other characters in the TIN are codes used at the tire manufacturer's discretion and vary by company.

Tire Size & Type Designation

To maintain tire safety, new tires purchased should match the OEM specifications of your RV's original tires. The tire specifications are found on your *Tire and Loading Information label* or the sidewall of the tire you are replacing.

The tires on your unit may for example, be marked with a designation of **ST 225/75R15**. *ST* stands for *Standard Trailer*, and the number breaks down as follows:

- The first three-digit number gives the width in millimeters of the tire from sidewall edge to sidewall edge. In general, the larger the number, the wider the tire.
- The next two-digit number after the “slash” mark, gives the height to width ratio of the tire. This is also known as the aspect ratio.
- The “**R**” stands for radial.
- The last two-digit number is the diameter *in inches* of the wheel or rim.

For further information, please contact a tire dealer or Grand Design RV Customer Service.

Speed Rating

- Typical **ST** tires have a speed rating designation of “**L**”, which is 75 mph (under normal inflation and load conditions).
- **DO NOT exceed the Speed Rating** regardless of the posted maximum speed limit.

Tire Warranty

- **Tires are warranted by the TIRE MANUFACTURER, not by Grand Design RV.**

If you need tire warranty assistance, please refer to the tire warranty information provided in your Owner Information Package or contact your dealer.



Tire Tread Wear Bars

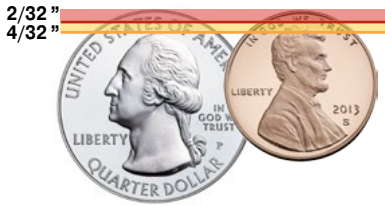

Tire Tread

The tire tread provides the gripping action and traction that prevent your vehicle from slipping or sliding, especially when the road is wet or icy. In general, tires are not safe and should be replaced when the tread is worn down to 1/16 of an inch.







Tread wear bars are raised sections built into the bottom of a tire’s tread grooves that show how much tread is remaining. When they appear “even” with the outside of the tread, it is time to replace your tires.

The Penny & Quarter Tests

Place a penny or quarter upside down into the tire groove.

- **Penny** - If you can see the top of Lincoln’s head, you are ready for new tires.
- **Quarter** - If you can see the top of Washington’s head, tires are OK but close to wearing out.

Inspect your tires regularly for uneven tread wear.

Wear Pattern	Possible Cause	Solution
 <p>Edge Wear Thin Tread Wear on Tire Edges</p>	Under Inflation	Fill tire with an air compressor to the Recommended Cold Tire Pressure
 <p>Center Wear Thin Tread Wear Center of Tire</p>	Over Inflation	Press tire valve stem, slowly release air until reaching the Recommended Cold Tire Pressure
 <p>Side Wear Exaggerated Inner or Outer Tread Wear</p>	Loss of Camber or Overloading	Make sure your load does NOT exceed the axle rating.
 <p>Toe Wear Thin Inner or Outer Edge</p>	Alignment or Incorrect Toe-in	Correct Toe-In is 0 - 0.5 degrees
 <p>Cup Wear Diagonal “Scalloped” Tread Wear</p>	Loose Bearings or Wheel Balance	Check Bearing Adjustment and Tire & Wheel Balance
 <p>Flat Spots Flat Spots or Patchy Tread Wear</p>	Tire Skidding Wheel Lock Up or Out of Balance	Avoid Sudden Stops, Adjust Brakes Check Tire & Wheel Balance

Tire Ply Composition & Materials

Tires are constructed from multiple layers of rubber-coated fabric. Each of these layers is called a *ply*. In general, the higher the number of plies in a tire, the more weight it can support.

- Tire manufacturers must report all materials used in the composition of their tires, (*ie.*, *steel*, *nylon*, *polyester*, *etc.*)

Spare Tire

The spare tire is used if a trailer tire is damaged, flat, or loses air pressure. ***The spare tire/wheel may differ from the original equipment, and is intended for temporary use ONLY***

Tire Changing Basics

- ***Hydraulic Jack & Jack Stands are customer supplied.***
 1. See **page 65**, *Roadside Emergency*.
 2. Block the wheels on the opposite side from the tire you wish to change. This will prevent accidental movement.
 3. Loosen the wheel lugs BEFORE raising the RV.
 4. Place a *Hydraulic Jack* on the frame close to the spring hanger. Raise the trailer until the tire clears the ground
NEVER attempt to use a stabilizer jack to lift the RV.
 5. Set up a *Jack Stand* under the frame just to the rear of the tire being changed, *then* change your tire.
 6. Follow the Wheel Nut Torque and Wheel Installation instructions provided on the ***Next Page***.

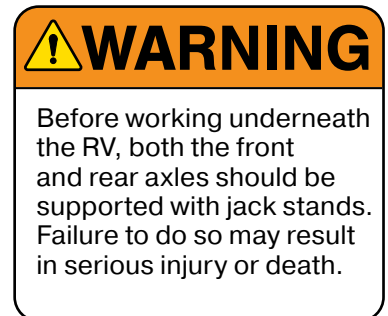

! WARNING

Always torque the wheel nuts to the specifications of the wheel manufacturer.

Over or under-torqued wheel nuts can cause the wheel to separate from the wheel mounting surface during operation, causing property damage, personal injury or loss of life.

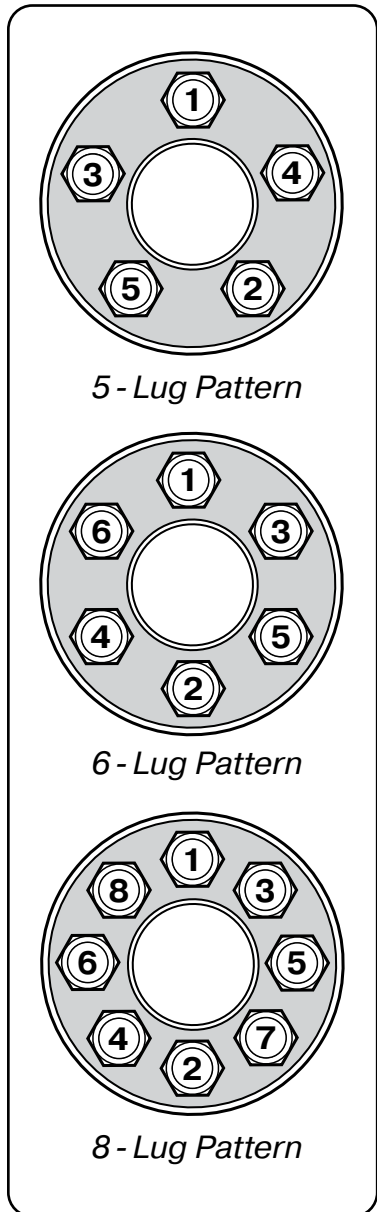

Wheel Nut Torque

- **The lug nuts on your RV wheels require frequent torque maintenance.**
- *Torque* is the amount of rotating force applied to a fastener, such as a lug nut.

Your RV's axle and wheel assemblies are designed differently than those of a car. The RV's overall size, weight, and center of gravity subject the wheels to pressures unique to trailering. During normal cornering, the tires and wheels experience a considerable amount of stress called *Side-Load*.

- **ALWAYS use a properly calibrated torque wrench to confirm proper torque.**
- **ALWAYS check lug nut torque on each wheel before departure, regardless of how short the trip may be.**
- **DO NOT** allow *UNDER*-torque or *OVER*-torque on any wheel. Under or over-torque can be dangerous or cause damage.
- Tighten the lugs in the correct order for your RV's lug pattern shown in the diagram. (*Left*)

Find the Wheel Size, Material, & Stud Size for your RV on the Wheel Torque Requirement Table (Below)

Stud Size	Lug Nut Type	Final Torque Specifications	Wheel Size	Wheel Material
1/2"	Coned	90-120 ft. lbs.	14"/15"/16"	Steel
9/16"	Coned	120-140 ft. lbs.	16"	Steel
1/2"	Coned	90-100 ft. lbs.	14"/15"/16"	Aluminum
9/16"	Coned	120-140 ft. lbs.	16"	Aluminum
9/16"	Coned	140-170 ft. lbs.	17.5"	Aluminum

If Changing the Tire/Wheel:

- Start all lugs by hand until snug, *then* tighten the lugs in three (3) stages.

1st Stage - Tighten all lugs to 20-25 ft. lbs

2nd Stage - Tighten to 50% of Final Torque Specification

3rd Stage - Tighten to the Final Torque Specification.

- Determine the correct torque for each stage, and use the Final Torque Specification shown.

Roadside Emergency

A roadside emergency can happen at any time. ALWAYS carry an emergency kit with three red warning signs (or indicators) to display if necessary.

If you must make an emergency roadside stop:

- Pull off the road *as far as possible*.
- Turn ON the hazard warning flashers (or hazard lights) to alert other drivers.
- The hazard warning flashers warn passing drivers to approach and overtake your vehicle with caution.

Place the three (3) Red Warning Indicators (*signs, reflectors, lanterns, or road flares*) as follows:

1. **1st** indicator **10 feet behind** the RV on the off-door side (*road side*).
 2. **2nd** indicator **100 feet behind** the RV in the center of the lane.
 3. **3rd** indicator **100 feet in front** of the RV in the center of the lane.
- **10 feet = 4 paces, 100 feet = 40 paces**
 - Curves and/or hills may affect the safe placement of the warning indicators.

FOR YOUR PERSONAL SAFETY in the event of a roadside emergency, ALWAYS STAND:

- **OFF of the road, and**
- **AWAY from any traffic.**

Emergency Towing

If you require towing, please contact an emergency road service provider or a qualified service facility for assistance.

This page is intentionally blank.

Towing & Leveling

To improve safe driving and help protect against injury, please follow these recommendations:

- Keep the RV and tow vehicle tires properly inflated, *and REPLACE* the tires **BEFORE** they are excessively worn.
- **ALWAYS** wear your seatbelt and obey all traffic laws.
 - **DO NOT** exceed the posted speed limit.
 - Many states have *lower* speed limits for tow vehicle/RV combinations.
- **ALWAYS** be a courteous and alert driver.
 - Watch out for other drivers, bicyclists and pedestrians.
 - Pay attention to traffic and road conditions.
 - **BEFORE** changing lanes, check the outside rearview mirrors for other vehicles and use your turn signals.
 - Leave room for sudden braking and other unexpected events.
- **ALWAYS** use the daytime running lights on your tow vehicle to increase visibility to other drivers.
- **NEVER** drive when you are sleepy or tired.
- **NEVER** drive when alcohol, drugs or medication have affected your judgment, reflexes or alertness.
- Adverse weather conditions or extreme terrain may affect your tow vehicle's performance and handling.
 - **DO NOT** use the tow vehicle's cruise control on icy, wet, or winding roads; or any other traffic situations where a constant speed could be dangerous.

Propane Safety

- **ALWAYS** shut **OFF** the propane system at the LP cylinder **BEFORE** you travel.
- If you drive with the propane system **ON**, the dangers are greatly increased in the event of an accident or fire.
- While you travel, most refrigerators will keep food cold or frozen for eight hours without running.

WARNING

DO NOT leave children or pets unsupervised in or around the RV (even if children are secured by a child restraint system).

They could:

- Injure themselves on parts of the RV.
- Unlock and open the entry door or open the emergency exit window and possibly injure other person(s) or damage property.
- Get out of the RV and injure themselves or they could be injured by passing vehicles.
- Be seriously or even fatally injured by prolonged exposure to extreme heat or cold.

WARNING

You must observe the law if you are driving when operating a cell phone in your tow vehicle. If it is permitted to operate a cell phone while the tow vehicle is in motion, you must only operate it when road and traffic conditions permit. You may otherwise be distracted from the traffic conditions, cause an accident and injure yourself and others.

RV Driving Schools & Seminars

If you have any concerns about driving while towing a RV, consult an expert for specific RV driver education. There are private RV schools and some RV owner's organizations that offer driving seminars. The schedules and locations of the various RV driver education seminars and schools can be researched through RV-related publications and websites.

Please use caution when using websites as a resource tool. Verify the information is from a credited and reliable source in the RV industry, and pertains to your specific RV. If in doubt, contact your dealer for assistance.

RV Braking System

To maintain proper braking performance, both the RV and tow vehicle brakes *must* be used together. The RV brakes are designed to work with your tow vehicle brakes. Separate use of the braking systems will cause accelerated wear and damage.

For best performance and increased durability, AFTER the initial break-in period, your brake shoes *must* be adjusted accurately. When your RV is new, it is impossible to adjust the brake shoes precisely. It takes approximately 1,000 miles and/or 50 medium to heavy stops to *burnish fit* or *seat* the shoes to the brake drum.

Braking system components include:

- Tow vehicle battery
- Brake controller
- Breakaway switch
- Wire harness/connector plug
- Auxiliary batteries (see Electrical System)

Tow Vehicle Battery

The tow vehicle battery is the primary source of power for your RV's brake operation. To ensure available power when needed, keep your tow vehicle battery and charging system working properly.

Battery Isolator (Customer Supplied)

You may want to install a *battery isolator* on your tow vehicle. A *battery isolator* is a device that:

- Receives current from the tow vehicle alternator to independently charge both the RV auxiliary battery and the tow vehicle battery.
- Prevents the RV from draining your tow vehicle battery (so you can start your tow vehicle engine).

Your dealer can assist you with the selection, purchase and installation of this aftermarket part.

Brake Controller (Customer Supplied)

The brake controller should be installed in the tow vehicle to work in conjunction with the RV electric brakes. Consult with your dealer or the brake controller OEM to decide what is right for your towing combination.

Breakaway Switch

The breakaway switch is located on the A frame. It is a crucial part of the RV braking system. If the RV becomes detached from the tow vehicle, the lanyard pulls the pin from the breakaway switch, which automatically activates the RV brakes.

- While hitching the RV, ALWAYS secure the breakaway switch lanyard to a permanent part of the tow vehicle.
- Check that your auxiliary battery (customer supplied) is correctly installed, and fully charged BEFORE travel.

An auxiliary battery (customer supplied) MUST be installed to provide power to the breakaway switch.

WARNING

Be certain there is enough “slack” in the lanyard (cable) to accommodate a tight radius turn. Failure to do so may result in the breakaway pins pulling out of the housing causing the brakes to engage while towing. This could result in significant damage.

WARNING

NEVER use the breakaway switch and trailer brake system as a parking brake. Doing so would create a high amp draw on the battery and converter.

This can cause non-warranty damage to the breakaway switch, wiring, & connectors.



DO NOT remove the following label from the A frame:

SAFETY BREAK-AWAY SWITCH WILL NOT OPERATE
unless connected to a power source equivalent to or greater than an automotive type 12 volt, 12 amp hour wet-cell battery.

! WARNING

ALWAYS use safety chains when towing your RV.

Safety chains maintain the connection between the RV and tow vehicle in the event the trailer becomes detached during travel.

Safety Chains

Safety chain requirements vary from state to state. Your RV is equipped with chains to meet SAE standard requirements for maximum gross trailer weight.

- ALWAYS have the safety chains attached when towing.
- Hook them to the safety chain loops provided on the tow vehicle's hitch, crossing them under the trailer tongue.

Inspect the length of the chains once attached to the tow vehicle frame. They should be long enough to allow for sharp turns, but short enough so they do not drag on the ground. Slack for each length should be the same but not more than necessary to permit the vehicle to turn at its minimum radius.

7-Way Wire Harness/Connector Plug

The *7-Way Wire Harness/Connector Plug* is wired into your TT to connect electrical power from the tow vehicle for travel. This supplies power to the RV brakes, tail lights, clearance lights, turn signals, brake lights, etc. Wiring to operate your brakes must be the same size in both the tow vehicle and RV.

Maintenance

Corrosion may build up with extended use. CLEAN your *Connector Plug* as needed to ensure good electrical contact. INSPECT the *7-Way Wire Harness/Connector Plug* periodically for cracking and wear to make sure connections stay protected from the elements as you travel. REPLACE if cracked or broken.

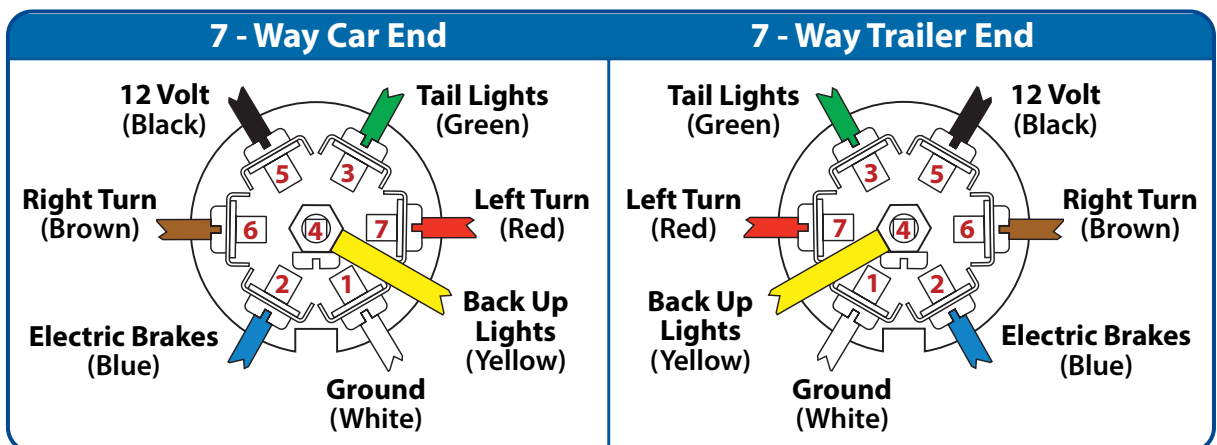

Tow Vehicle Hitch (Customer Supplied)

There are many types of hitches available. The hitch type that you select will affect the towing and handling characteristics your RV. Installing the correct hitch on your tow vehicle is critical to a safe towing experience.

- Your Momentum M.A.V. TT requires a tow vehicle frame mounted hitch. Consult your dealer for which class and type of hitch to purchase for your TT / tow vehicle combination.
- BEFORE selecting a hitch, you must know the *GVWR* and *HITCH WEIGHT* of your RV.
- A hitch is assigned a *Hitch Class Rating* based on its maximum towing capacity and receiver opening size.
 - **The Maximum Towing Capacity of your hitch must be *HIGHER THAN* your GVWR**
- The *hitch class rating* also gives a maximum hitch weight.
 - **The Maximum Hitch Weight for your hitch must be *HIGHER THAN* your hitch weight.**

There are a variety of tow vehicle suspension systems available that will affect the ball height, stability and levelness of a hooked up RV.

- A suspension that is too stiff, will increase vibration and bounce, accelerating wear on your tow vehicle and RV combination.
- Equipment that gives your vehicle a softer ride, can sometimes accentuate swaying when pulling an RV.

Please consult your dealer to assist you with purchasing a compatible hookup.

Hitch Weight

Maintain the *hitch weight* of your trailer when your cargo changes or is reloaded. Adjust to stay within the approximate target range of 10–15% of your overall Gross Weight (travel trailer *plus* cargo).

- If your hitch weight *EXCEEDS* the *upper weight limit*, shift some cargo toward the rear of your RV.
- If your hitch weight is *LESS THAN* the *lower weight limit*, shift some cargo toward the front of your RV.

NOTE: The *Cargo Weight* **must** be BALANCED side-to-side, then SECURED in place.

CAUTION

DO NOT overload your tow vehicle.

- Using an oversized or undersized tow vehicle hitch can cause damage to the RV frame.
- Grand Design RV cannot be responsible for the tow vehicle suspension system.
- The final ball height after the two vehicle/travel trailer towing combination is completely hooked up is a factor that must be considered.
- To avoid overloading your trailer axles and to minimize possible handling difficulties, your trailer should be level when hooked to your tow vehicle.

WARNING

Too much hitch weight can lift the tow vehicle's front wheels to the point where steering response, traction and braking are adversely effected. Suspension or drivetrain damage can result.

Too little hitch weight can diminish rear-wheel traction and cause instability, swaying or jackknifing.

Hitch Height & Hitch Ball

To determine your RV hitch height, make sure the RV is level. When the loaded trailer is hitched to the tow vehicle, check the hitch ball height by measuring the distance from the center of the hitch ball to the ground. Record your RV hitch height measurement in the box for future reference.

- **To adjust the weight-distributing hitch to the proper height, refer to the hitch manufacturer instructions.**
- Adjust the equalizing bars of the hitch assembly until the tow vehicle and the RV are essentially level.
- A **HIGH hitch** will transfer weight behind the axles and cause the RV to fishtail.
- A **LOW hitch** will transfer additional weight to the hitch.

Your required hitch ball size is stamped on the hitch coupler. Depending on your floor plan, your travel trailer requires a hitch ball diameter of either 2" or 2 ⁵/₁₆."

If you have additional questions, consult with your dealer.

Sway Control (Customer Supplied)

Aftermarket sway control devices are available to reduce the sway produced by crosswinds, air displacement caused by other vehicles passing you in transit, incorrect weight distribution, excessive speed, the RV tires dropping onto the shoulder of the road, etc. The use of a sway control device will help to control the side-to-side movement and keep sway in check.

Suggestions for sway situations:

- Slowly ease your foot off the accelerator.
- Turn the steering wheel as little as possible.
 - Natural lag time reaction when counter-steering to correct sway *could possibly make it worse.*
- If the trailer is equipped with electric brakes, using the hand control will help to keep the vehicles aligned.
- As soon as possible, stop to determine the cause of the sway.
 - Check all equipment and load distribution.
 - If the problem cannot be solved immediately, contact your dealer for a service appointment.
 - *Travel at a much reduced speed on your way there.*



Weight Distributing System (Customer Supplied)

Aftermarket weight distributing hitch systems provide a more stable tow vehicle/travel trailer towing combination. This system will spread the weight evenly to distribute it to the front and rear tow vehicle axles and the trailer axle.

Be certain your tow vehicle can carry the hitch weight.

Consult with your dealer to familiarize yourself with the operation and requirements of the weight distributing hitch system.

Travel Trailer Hitching Procedure

The following procedure will help assist you in securely hooking up your RV to your tow vehicle:

1. ALWAYS use wheel chocks to block the trailer wheels.
2. CHECK that the *Power Tongue Jack* is hooked to 12-volt power and turned ON, *then*
 - PUSH the RET/EXT control button on the tongue jack to raise the travel trailer tongue above the hitch ball.
3. OPEN the coupler latch on the travel trailer hitch.
4. Back up your tow vehicle into the proper position.
5. PUSH the tongue jack RET/EXT button to lower the tongue jack coupler onto the tow vehicle hitch ball.
6. CLOSE the coupler latch after it is completely seated and install the safety pin.
7. INSTALL the (customer supplied) *Weight Distributing Bars (or Equalizers)* as directed by the OEM.
8. REMOVE the tongue jack foot, and fully RETRACT.
9. CHECK that the stabilizer jacks are fully retracted.
10. ATTACH the breakaway switch cable to the tow vehicle.
11. ATTACH the safety chains.
12. CONNECT the 7-way wire harness from the travel trailer to your tow vehicle and secure in the travel position.
 - VERIFY the exterior lights are working correctly around the RV.
13. REMOVE the wheel chocks from the trailer wheels.

WARNING

NEVER allow anyone to go under the RV while it is being lifted and/or towed.

WARNING

DO NOT overextend or retract the power tongue jack or stabilizer jacks as that could cause damage which would not be warrantable.

WARNING

Both the power tongue jack and the stabilizer jacks must be fully retracted before moving or towing the RV to prevent damage.

 The power tongue jack's RET/EXT switch indicates the direction of the leg.

EXTEND - Raises the RV.
RETRACT - Lowers the RV.



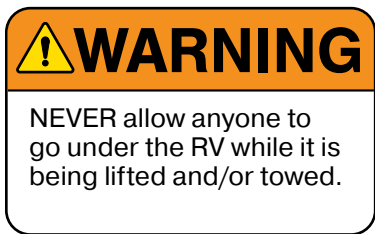
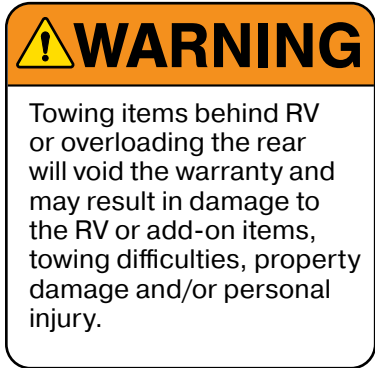

Towing the RV

Braking & Stopping Distance

Towing an RV greatly increases your stopping distance. Practice braking in a large parking lot (where it is permissible) to become familiar with your RV's stopping distance before driving in traffic.

- AVOID conditions that require excessive and prolonged use of your brakes. *Smooth starts* and *easing to a stop* will save wear and tear on your RV / tow vehicle combination.

When descending a long hill, drop into a lower gear (or a lower range, if you have automatic transmission). This allows your tow vehicle's engine and transmission to help control your speed which can extend brake life.

- Apply and release the brakes at short intervals to give them a chance to cool.
- Driving through deep water may get the brakes wet, increasing stopping distance or causing the vehicle to pull to one side.
- **DO NOT operate the vehicle if a difference in braking efficiency is noticeable.** Check the RV's brake operation in a safe area to be sure they have not been affected.

Weight and Clearance Limits

In order to obey all posted *Weight and Clearance Limits*, you **must** ALWAYS know the **Gross Weight** and **total Height** of your RV/tow vehicle combination.

- ALWAYS include the roof air conditioners, TV antennas, and floodlights as they may cause clearance problems under some tunnels, canopies or hanging signs.
- Some bridges, older ones in particular, may not support the weight of your RV/tow vehicle combination.

Road Conditions

ALWAYS adjust your driving for road conditions.

- Slow way down, *then* release your brakes before crossing railroad tracks.
- Sudden acceleration or deceleration on a wet or icy roads can cause skidding and loss of control.
- Slow down well in advance of any bumps or dips in the road to reduce jolting your RV / tow vehicle combination.
- Drive over any uneven surfaces *slowly* and make sure to have passed them *completely* before accelerating.

Passenger Safety

- **DO NOT allow anyone to ride inside as a passenger while your RV is in motion.**
- This practice is *against the law* in several states.

Turning Corners

While making a turn:

- The RV **does NOT** follow the path of your *Tow Vehicle*.
- The RV will make a **TIGHTER** turn than your *Tow Vehicle*.

You must *compensate* for this action by carefully pulling the tow vehicle out into the intersection further than you normally would so that the RV clears the curb (or any parked vehicles along the curb).

Passing

While towing an RV, it takes longer to reach highway speeds. Allow additional time to safely overtake and pass vehicles.

- Changing lanes in traffic also takes longer due to the extra length of your RV / tow vehicle combination.
- **ALWAYS** drive with caution and avoid situations that may require quickly changing your speed or your lane.

Backing Up

If there are no pull through sites at your camping destination, choose a level site and back in carefully. **BEFORE** you park, exit your tow vehicle, and inspect that site conditions are satisfactory.

- Check that you have plenty of vehicle clearance.
- Check that your path is free of obstacles.
(*low-hanging tree limbs, posts, large rocks*)
- Try to choose a site that is on the driver's side, so that you can easily see the rear of the RV.
- A site on the passenger side is more difficult, since you back into the site on your blind side.
- Position your tow vehicle and RV for backing into the site.
- Back up the RV slowly. Watch your tow vehicle mirrors and *Back Up Camera* (customer supplied) carefully to help you guide the RV into the site.
- Have another person outside the RV to assist you until the RV is parked in the desired position.

WARNING

- When making a turn, check the road clearance and be aware of others.
- Have someone help guide you out of a difficult parking space or traffic pattern.
- Swerves and sharp turns, especially at high speeds, could result in loss of control of the RV.



If the parking spot is on asphalt on a very hot day or on dirt and/or gravel, a block of wood under each jack leg can be used to spread the load and reduce the possibility of the leg sinking into the surface.



WARNING

DO NOT attempt to lift the RV with either the stabilizer jacks or the power tongue jack. These jacks are NOT designed to bear the total weight of the RV. Stabilizer jacks are only to help steady the trailer from movement.



WARNING

DO NOT use the stabilizer jacks for leveling on uneven ground or to change tires. NEVER use the jacks to elevate any wheel off the ground. Damage to the stabilizer jacks and RV frame can occur.



WARNING

DO NOT overextend or retract the power tongue jack or stabilizer jacks as that could cause damage which would not be warrantable.



WARNING

Both the power tongue jack and the stabilizer jacks must be fully retracted before moving or towing the RV to prevent damage.

Towing the RV, Continued

Parking

Once the RV is in your desired location:

1. Set the tow vehicle parking brake.
2. Turn OFF the ignition switch.
3. Go outside and block the RV wheels securely with wheel chocks.
 - *The wheel chocks can be wood blocks or purchased items as long as they prevent the RV from rolling.*

Leveling the RV

1. **ALWAYS check that you are parked on a mostly level surface, then**
2. **Disconnect your RV from the tow vehicle.**
 - All persons, pets and property MUST be clear of the RV while leveling is in progress.
 - Use a small level in the refrigerator, *and* on the counter top or floor to confirm the RV is level.

Leveling your RV is important

- The refrigerator (and other appliances) are designed to perform best when the RV is level.
- The water system is designed to drain properly when the RV is level.
- Sleeping and walking inside is more comfortable when the RV is level.

See the **Next Page**, *Travel Trailer Set Up*.

Stabilizer Jacks

The stabilizer jacks are located under the RV, attached to the frame. These jacks are designed *only* to stabilize the RV, and help prevent *bouncing* as occupants move around inside.

- Using the supplied crank handle, turn the drive nut *clockwise* extending the jack, until the foot pad makes firm contact with the ground.
- **DO NOT use the jacks to lift the trailer off the ground.**
- Place wooden blocks under the foot pads to prevent them from sinking into soft ground.

Travel Trailer Set Up

1. Position the RV as desired, *then*
 - Block the wheels to keep the RV from rolling.
2. Unhook the 7-way wire harness/connector plug, safety chains and breakaway switch cable.
3. Release the weight distributing bars (customer supplied).
4. Disconnect your tow vehicle from the RV.
5. Install the tongue jack foot.
6. Open the tongue jack coupler latch.
7. Check that the *Power Tongue Jack* is hooked to 12-volt power and turned ON, *then*
 - Use the RET/EXT control button on the tongue jack to raise the travel trailer tongue above the hitch ball.
8. Level the RV (*front-to-back*) with the power tongue jack.
9. Extend each stabilizer jack using the supplied crank handle, turn the drive nut *clockwise*, until the foot pad makes firm contact with the ground.
 - Place wooden blocks under the foot pads to prevent them from sinking into soft ground.
 - **All Four (4) jacks *must* have about equal pressure.**
 - **Uneven pressure on the jacks can *twist* the unit,** causing doors and slide-outs to bind and/or operate intermittently.
10. Pull away your tow vehicle.

Once the RV is stabilized, continue setting up the RV by connecting to the site facilities, extending the slideouts, etc., according to your personal preferences and needs. There is no particular order to set up procedures. With practice you will find the order that works best for you.

NOTICE

Ensure that the RV is level before operating the slideout room.

Water leaks and other problems could result if the slideout is operated without leveling the RV.

This page is intentionally blank.

Electrical Systems

Your Momentum M.A.V. TT is equipped with two independent electrical systems. One system is 120-volt 60hz AC power, the other system is 12-volt DC power. The electrical equipment and associated circuitry are engineered into a dedicated system specific to your RV. All installations meet or exceed industry standards applicable on the date of manufacture.

- **A hazardous condition may result from changes or additions to RV electrical system made after delivery.**
- **Adding fixed appliances or making unauthorized changes is NOT recommended.**
- **ONLY a qualified electrical technician should perform service or modifications on the RV electrical system.**

*The **methods, components, and materials** used **MUST** be in compliance with current safety and code requirements. Please consult your dealer's service department for assistance.*

Electrical System Maintenance

- ALWAYS disconnect the negative 12-volt DC battery terminal and the shore power cord BEFORE working on the electrical system.
- ALWAYS turn OFF the power converter, BEFORE disconnecting the battery.

For more information on your RV's electrical system, See the component manuals in your Owner Information Package.

30-Amp or 50-Amp Power Cord

The power cord (or *shore power cord*) connects your RV to an external power receptacle. This heavy duty cord has a dual purpose. **When connected, it will:**

- **CARRY VOLTAGE & CURRENT** to your RV from the external power receptacle, *and*
- **GROUND** the electrical system of your RV through the external power receptacle.

BEFORE connecting your power cord, ALWAYS:

- TEST the external power receptacle or electrical box with a **Line Monitor/Outlet Tester** (customer supplied).
- **DO NOT** connect the power cord if the **Line Monitor** indicates **REVERSE POLARITY** or an **OPEN GROUND**.

WARNING

Use caution when using metal tools. If a tool makes contact with a battery terminal or the metal connected to it, a short circuit could occur which could cause personal injury, explosion or fire.

WARNING

The power cord **MUST** be fully extended when in use and **NOT** left coiled in the electrical compartment or on the ground.

If the power cord is left coiled, it may potentially create enough heat to melt its protective casing.



30 Amp Power Inlet



50 Amp Power Inlet

WARNING

- DO NOT hook up the power cord to any receptacle until you have verified proper polarity and grounding. Polarity indicators can be purchased in most electrical and hardware stores.
- DO NOT use any cheater plug, adapter or extension cord to reconfigure incoming AC power or break the continuity of the circuit connected to the grounding pin.
- DO NOT connect the power cord into an outlet that is not grounded, or adapt the power cord plug to connect it to a receptacle for which it is not designed.
- DO NOT remove the grounding pin to connect to a non-grounded receptacle. Removal of the ground pin disables an important safety feature designed to prevent electrocution and shock hazards.
- DO NOT connect the power cord to an extension cord. Use of an improper extension cord will cause overheating of the cord as well as potentially causing premature failure of the AC equipment.
- It is the *responsibility* of the electrical receptacle owner to ensure that it is properly wired and grounded.
- *Reverse Polarity and/or Improper Grounding* of your RV can cause personal injury or death.

30-Amp or 50-Amp Power Cord, Continued

Connecting the power cord

1. Turn OFF the load center main 120-volt circuit breaker.
2. Carefully extend the entire length of the power cord from the electric cable hatch to the external power source.
3. Plug the power cord into the receptacle. Make sure that all of the power cord prongs are properly seated into the receptacle.
4. Return to your RV and turn ON the load center main circuit breaker.
5. To help prevent power surges from damaging the connected loads, please follow these instructions when hooking up to the external power source:
 - a. Unplug the shore power cord when the RV is left unattended. This may help limit potential damage in the event of a power surge.
 - b. Use care to prevent damaging the connection pins when connecting or disconnecting the power cord.
 - c. Reverse the *Connecting the power cord* steps (1-5) listed above, when you are ready to leave.
6. ALWAYS disconnect the power cord from the outlet by the plug; NEVER disconnect the plug by pulling the cord.

Power Cord Maintenance

- INSPECT your power cord *frequently* for Cuts, Cracks, and Worn Insulation.
- REPLACE the cord immediately if any of these conditions are found.

120-Volt AC System

Your RV is equipped with either a **30 amp** or a **50 amp** electrical system (select models). **It is important that you know which system is equipped on your RV.**

- The **30 amp** 120 volt 60hz AC electrical system is designed to operate on one (1) leg of 120-volt power at a maximum current flow of 30 amperes.
- The **50 amp** 120 volt 60hz AC electrical system is designed to operate on two (2) legs of 120-volt power at a maximum current flow of 50 amperes per leg.

Power to your 120-volt 60hz AC electrical system (30 amp or 50 amp) can be supplied by the 120-volt 60hz utilities found at RV campgrounds or by a generator. A campground's electrical service may occasionally experience high or low voltage.

- **Exposure to voltages higher or lower than 120-volts will damage or shorten the service life of the electrical system and appliances.**

The following electrical components (if so equipped) will operate **ONLY** when your RV is connected to shore power: 120-volt to 12-volt power converter, air conditioner, 120-volt refrigerator, microwave oven, television(s), fireplace, and other appliances that plug into convenience electrical receptacles.

For recommendations on power-surge protection, Consult your dealer.

120-Volt Circuit Breakers

The 120-volt AC circuit breakers are located in the main load center. They protect all of the 120-volt wiring and components. Each circuit is identified on a label inside the load center.

- An *overload* or *short circuit* will cause the breaker to *trip*, stopping the flow of electricity for the affected circuit.
- If a circuit breaker *trips*, turn OFF the appliance on that circuit. Allow some time for the circuit breaker to cool.
- **To RESET the circuit breaker**, flip the switch to the OFF position, then flip it back to the ON position.
- If a breaker immediately trips again or trips frequently, contact your dealer to diagnose and repair the problem.

Maintenance and replacement

Circuit breaker switches can wear out. Test the breakers annually, at the beginning of the camping season. Replace them as needed, during normal maintenance.

- **To TEST:** Flip each breaker switch to the OFF position, then back to the ON position.

For further information, Contact your dealer.

WARNING

For 30 amp systems only:
Make certain the external power source you connect the power cord to is a **30-amp NEMA TT-30R RV receptacle** and not a 240 volt AC.

WARNING

For 50 amp systems only:
Make certain the external power source you connect the power cord to is a **50 amp NEMA 14-50 RV receptacle** and not a 240 volt AC.

WARNING

Replacement circuit breakers must be of the same voltage, amperage rating and type. Never use a higher rated replacement circuit breaker; doing so may cause a fire by overheating the RV wiring.

CAUTION

Circuit breakers and fuses will not offer complete protection of the electrical system in the event of a voltage spike/power surge

Converter

The Power Converter changes 120-volt AC power to usable 12-volt DC power when the shore power cord is connected to an external power source. A thermal breaker is built-in to the converter to protect it from overheating.

Overheating is usually caused by the converter operating above its maximum power output for an extended time period, or with too little air flow.

- To reduce converter heat, DO NOT run any unnecessary 12-volt lights/motors/appliances, *and*
- Keep the converter cooling fins and fan clear of obstructions.

Inspection and maintenance

If the 12-volt power converter is NOT working, or the auxiliary battery is not being charged:

1. Locate the converter fuse panel on one end of the converter.
2. Check the reverse polarity fuse or fuses.

The manufacturer's warranty will be void if the case has been removed. There are no customer serviceable parts inside.

For further information, Contact your dealer.

GFCI Receptacle

Grounding is your personal protection from electrical shock. Each RV has a ground fault current interrupter (GFCI) engineered into the electrical system. This device has been designed to reduce the possible injury caused by electric shock. The GFCI will not protect against short circuits or circuit overloads.

- A *tripped* GFCI receptacle indicates that abnormally high 120-volt current flow (a ground fault) was detected through the electrical system grounding circuit.

A fault condition can be caused by faulty wire insulation, wet wiring inside an appliance, or faulty electrical equipment connected to the circuit, etc. All ground faults must be repaired before use of the RV.

Test all GFCI receptacles monthly

- **Push in** the *TEST* button. This should **pop out** the *RESET* button, indicating the GFCI receptacle has been *tripped*. This will interrupt 120-volt power.
- **Push in** the *RESET* button. This should restore 120-volt power.

Contact your dealer for assistance, if the RESET button does NOT restore 120-volt power or trips repeatedly.

12-Volt DC System

Many of your RV components including the light fixtures, water pump, motors and appliances run on 12-volt electricity.

- The **Converter** supplies 12-volt power when your RV is connected to external power. The converter will also charge the Auxiliary Battery in most situations.
- The **Auxiliary Battery** supplies 12-volt power when your RV is NOT connected to external power.
- The **Tow Vehicle Alternator** supplies 12-volt power when the *7-Way Wire Harness* is connected, and the tow vehicle engine is running.

This runs the components needed for travel including, the brake lights, turn signals, brakes, running lights and the breakaway switch. In addition, the *7-Way Wire Harness* provides a common ground and a charge line to your auxiliary battery.

12-Volt DC Outlet (If So Equipped)

Your RV may include a 12-volt DC outlet (not applicable on all models). **ONLY** use this outlet for an appliance that runs on 12-volt DC power and consumes less than 60 watts (5 amps).

- **To prevent a short circuit, keep the 12-volt DC outlet free of any (metallic) foreign material.**

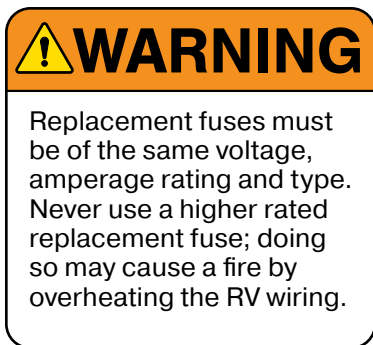

12-Volt Fuse Panel

- The label inside the 12-volt fuse panel indicates the fuse sizes, positions and components powered. The fuse panel label should be kept permanently affixed to your RV.
- Inspect all 12-volt fuses at the beginning of each camping season, and replace as needed.
- The fuses may not offer complete protection of the RV electrical system in the event of a power surge or spike.

Replacing a fuse

- **Before** replacing a fuse, **always** TURN OFF or UNPLUG the component(s) it protects.
1. DISCONNECT the shore power cord.
 2. DISCONNECT the negative cable from the RV auxiliary battery.
 3. REMOVE the fuse panel cover to check fuses.
 4. PULL the fuse straight out of the fuse block.
 - *If the fuse is not blown, please contact your dealer to determine the cause of the problem.*
 5. ALWAYS replace with a new fuse of the same specified voltage, amperage rating and type in the original location.
 - NEVER use a *higher rated* replacement fuse.

Auxiliary Battery

The 12-volt DC electrical system is designed for use with a **Group 24** or **Group 27 deep cycle battery**.

- **Your RV has many individual 12-volt DC loads. When combined, the total load is higher than the converter can produce.**
- High demands for 12-volt power can be met by an *auxiliary battery* for limited periods of time.

Dry camping

When dry camping, it is recommended you consider the charge condition of the auxiliary battery AND plan your electrical usage accordingly.

- If the RV is drawing power solely from the auxiliary battery **without recharging**, it will become **depleted**.
- As the battery's charge becomes **lower**, it will also **discharge at a faster rate**.

For accuracy, test the auxiliary battery voltage using a volt-ohm meter. A fully charged auxiliary battery will read 12.7 volts DC and 1.265 specific gravity at 80°F (32°C).

The auxiliary battery is considered discharged at 11.8 volts, and dead at 11.65 volts. Permanent damage may occur when voltage drops below those levels. Typically, a deep cycle battery has an amp-hour rating of 75-100 amps.

If the furnace and refrigerator are operating simultaneously, approximately (12.0 + 3.0) 15.0 amps per hour are used. This does not include any 12-volt lights, water pump or any other 12-volt component.

In the above example, if the furnace and refrigerator operated constantly, a 75 amp-hour battery would become fully discharged in 5 hours ($75\text{ah} \div 15\text{a} = 5\text{h}$).

The RV's auxiliary battery should be installed in parallel with the battery in your tow vehicle. When the 7-way trailer plug is connected, *both* batteries power the RV.

- **It is very important NOT to discharge your tow vehicle battery below the level required to start the engine.**

To prevent this from occurring, disconnect the 7-way trailer plug or install a *Battery Isolator* (customer supplied). When the tow vehicle engine is operating with the RV connected, the tow vehicle charging system will charge both batteries.

Replacement and maintenance

Some equipment in your RV will draw small amounts of current even when turned OFF. To prevent the auxiliary battery from being discharged when your RV is not connected to shore line power, disconnect the auxiliary battery negative cable at the battery. During storage, it is important to check the voltage monthly and recharge the auxiliary battery as needed. If you remove the auxiliary battery from your RV, store it in a dry, cool area per the manufacturer's instructions.

When it is time to replace the auxiliary battery, replace it with a **Group 24 or Group 27 deep cycle battery ONLY**.

- **DO NOT reverse the positive and negative battery cables (doing so will blow the reverse polarity fuse(s) that protect the converter).**

Contact the battery manufacturer for further information.



Battery Disconnect Switch

Battery Disconnect Switch

The *Battery Disconnect Switch* (see photo) is located on the Universal Docking Station. **At times when auxiliary power will NOT be needed:**

- TURN the *Battery Disconnect Switch* to the OFF position and REMOVE key.
- The Power Tongue Jack and all 12-Volt safety items will remain operational.

When you are ready to use your RV's interior features:

- REPLACE key, and TURN the *Battery Disconnect Switch* to the ON position.

If the RV will be in STORAGE: Also DISCONNECT the battery cables from the auxiliary battery terminals. See **page 153**, *Winterizing / RV Storage Preparation, #12*.

Calculating Electrical Load

While connected to external power and using appliances, remember that the 120-volt electrical system can run a *maximum* of 100 amps. If you overload the RV and/or campground electrical system, a circuit breaker *trip* may occur.

- **Added together, the amperage of each appliance and component running at the same time, must NOT exceed 100 amps.**

To calculate the amperage rating for each individual appliance, divide the *wattage* by the *voltage* (both should be listed on the appliance). For example: **1200 watts divided by 120 volts equals 10 amps.**

See the **Next Page**, *Approximate Electrical Load Ratings*.

Replacing Light Bulbs (Customer Supplied)

- BEFORE replacing a bulb, turn OFF the light switch.
- **Using the wrong bulb can overload the lamp circuit and overheat the fixture, creating a FIRE HAZARD.**
 - CHECK that your replacement bulbs match the type, wattage and voltage listed on the lamp fixture.

Approximate Electrical Load Ratings

Use the actual amperage of the appliance when possible.
(Watts ÷ Volts)

120 Volt System	
Air Conditioner	14-18 amps
Coffee Maker	6-12 amps
Converter (Each)	8-11 amps
Curling Iron or Hair Dryer	10-14 amps
DVD / Blu-ray Player	3 amps
Microwave	12 amps
Refrigerator	6 amps
Satellite Receiver	2 amps
TV	2-4 amps
Vacuum Cleaner	8 amps
Washer / Dryer	12 amps
Water Heater	12 amps

12 Volt System	
Aisle Lights	0.5 amps
Baggage Compartment Lights	0.5 amps
Decorative Wall Lights	0.5 amps
Dinette Light	0.5-1 amps
Exterior Entertainment Center	1-3 amps
Fantastic Fan	1.5 amps
3" LED Puck Lights (Each)	0.22 amps
Furnace	8-10 amps
Generator Start	95.0 amps *
Illuminated Switch	.125 amps
Inverter	<i>Variable</i>
Leveling System	95.0 amps *
LP Detector	.125 amps
Map Light	1.5 amps
Porch Light	1.5 amps
Power Awning	10.0 amps
Power Vent	5.0 amps
Refrigerator	3.0 amps
Shower Light	0.22 amps
Step Cover	10.0 amps
TV Plate / Antenna Booster	1.0 amps
Vanity Light	0.22 amps
Water Heater	6.0 amps
Water Pump	7.0 amps
* <i>Momentary load</i>	



Solar Docking Port



MPPT Solar Charge Controller

Solar Docking Port

The *Solar Docking Port* is standard equipment, installed on the roof of your RV. It is designed for use with either an OEM or customer supplied *Solar Power Charging System*.

Solar Power Charging System (If So Equipped)

Please read and understand the manufacturer's manuals for your *25 Amp MPPT Solar Charge Controller* and *Solar Panel* BEFORE using the *Solar Power Charging System*.

See photos, below left.

- Follow all safety alerts, warnings, and instructions when using the *Solar Power Charging System*.

The *Solar Power Charging System* efficiently charges your RV battery by converting the energy from a roof mounted solar panel to 12 Volt DC.

- Once fully charged, the *MPPT Solar Charge Controller* also protects your battery from overcharging by limiting the current flow from your solar array.

Battery Monitor

Please read and understand the manufacturer user manual found in the owner's information package.

- Each battery has a capacity rating, typically measured in Amp-hrs (Ah). For accurate use, the meter needs to be calibrated and set for the battery capacity.
- Follow the steps in the manufacturer's user manual to keep accurate calibration.

FURRIIONNET-ZERO

Rigid Solar Panels
Panneaux solaires rigides
Paneles solares rígidos

Instruction Manual
Manuel d'instructions
Manual de instrucciones

Model/Modèle/Modelo
FSFP10MW-BL
FSFP16MW-BL
FSFP19MW-BL



* Picture shown here is for reference only.
L'image montrée ici est pour référence seulement.
La imagen que se muestra aquí es sólo para referencia.

FURRIIONNET-ZERO

MPPT Solar Charge Controller
Régulateur de charge solaire MPPT
Controlador de carga solar MPPT

Instruction Manual
Manuel d'instructions
Manual de instrucciones







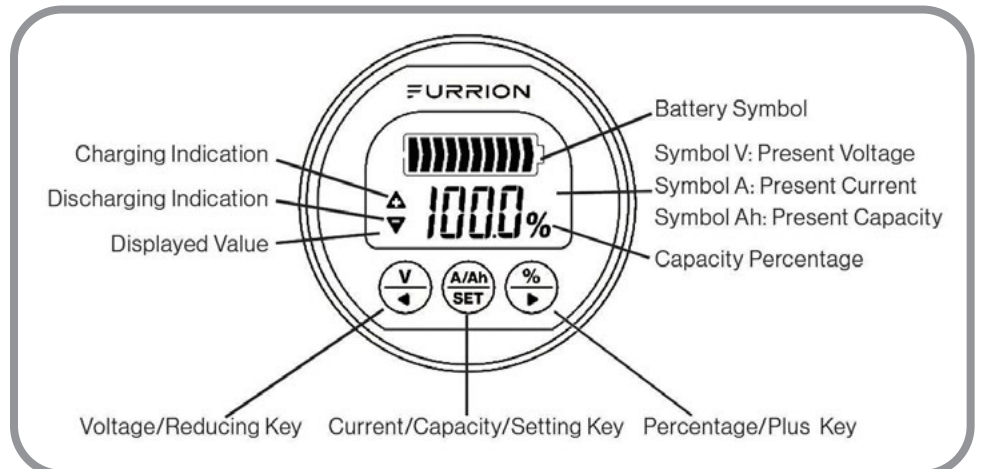

* Picture shown here is for reference only.
L'image montrée ici est pour référence seulement.
La imagen que se muestra aquí es sólo para referencia.

Model/Modèle/Modelo:
FSCC30PW-BL FSCC60PW-BL
FSCC30PW-BL-FSCC30PW-BL-FSCC60PW-BL
FSCC60PW-BL-FSCC60PW-BL-FSCC60PW-BL





Navigating the Meter Display

1. Checking Current: Press  to display amperage (A) or current. This will show the current flowing in and out of the battery. If the arrow is  the current is flowing into the battery and is charging. Likewise, if the arrow is  the current is flowing out of the battery and it is dis-charging.
2. Checking Voltage: Press  to display the real-time voltage of your battery bank.
3. Checking Battery Capacity: It is important to monitor the status of your battery capacity to ensure ample power will be available. The capacity will increase or decrease depending if the battery is charging or discharging, Battery capacity can be displayed in two ways:
 - **Amp-hr (Ah) Battery Capacity:** Press  to display Ah. The number displayed indicates the Amp-hr (Ah) power capacity remaining in the battery bank,
 - **Battery Capacity “Fuel” Gauge:** Press  to display the % “Fuel” remaining in the battery. This is the easiest display to understand how much power remains in the batteries until empty

Display Function

1. The display back-light will be a slow-cyclical pulsing illumination if the battery is charging.
2. The display back-light will be a constant illumination if the battery is dis-charging.
3. The display back-light will not illuminate if the battery is neither charging or dis-charging.

Turning Back-light ON/OFF

Press  and  together for three (3) seconds to turn the back-light ON/OFF.

Specifications

Working Voltage	8-30V
Working Consumption	10.0-120mA
Stand-by Consumption	0.5-0.6mA
Sleep Consumption	50.0-60uA
Accuracy of Voltage Collecting	(+ / -) 1.0%
Accuracy of Current Collecting	(+ / -) 1.0%
Accuracy of Capacity Collecting	(+ / -) 1.0%
Back-light on Current (>50A specification)	100mA
Setting Value of Capacity	0.1-999,0Ah
Temperature Range in Application Environment	-10-60°C (14-140°F)



Battery Monitor

This page is intentionally blank.

Plumbing Systems

There are two separate water systems equipped on your RV, the *Fresh Water System* and the *Waste Water System*.

- The **Fresh Water System** consists of the fresh water holding tank, fresh water connections, water heater, water pump, faucets, shower/tub and if so equipped, an outside shower assembly and/or water purification system.
- The **Waste Water System** consists of the waste water holding tank, sewage holding tank, drains and toilet.

BEFORE each trip or vehicle storage, and as part of normal maintenance, inspect the following for leaks:

- ALL fittings on BOTH water systems.
- ALL faucet and sink connections (including drain baskets or filters).
- ALL water pump and water heater connections.
- **At the end of each trip, ALWAYS completely drain your fresh water system.**

Fresh Water System - First Use

Your new RV may have been winterized, as indicated by temporary labels located in the universal docking station.

- **BEFORE the first use**, the system should be **Sanitized**, even if it has NOT been **Winterized**.
- **Sanitizing** the fresh water system will kill all bacteria and organisms that can contaminate your water supply.

Small amounts of contaminants and minerals are found in ALL water. They can sometimes cause your fresh water to have an odor. Usually, untreated well water is the source of water system odors.

See **page 101**, *Sanitizing the Fresh Water System*.

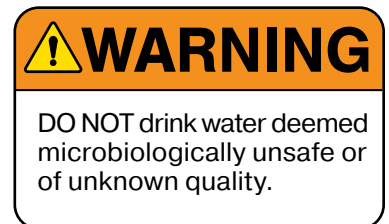

Monitor Panel

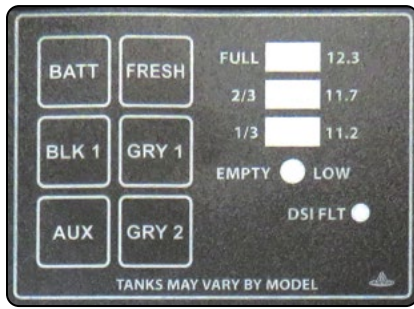

Monitor Panel

The monitor panel is found on the interior Command Center. It displays the fill levels of your fresh water, grey water, and black water holding tanks. It also shows the voltage of your auxiliary battery. To make a selection, *PRESS* and *HOLD* one of the labeled buttons on the monitor panel faceplate. Each holding tank is equipped with a sensor to instantly relay the fill level to the LED display. *See photo (left)*



Command Center

The monitor panel operates on 12-volt DC power supplied by either the converter or auxiliary battery. No power is drawn from the battery unless a button is pushed. Fuses for the monitor panel are located in the load center.

Operation

Press only one button at a time.

- When the *FRESH*, *BLK*, *GRY1* or *GRY2* button is pressed, the LED lights display the fill level of the selected holding tank.
- When the *BATT* button is pressed, the LED lights display the approximate voltage of your auxiliary battery.

Water pump switch

When the water pump switch is turned ON, the water pump runs until 45 pounds of pressure has been achieved. Turn the water pump switch OFF when it is not in use.

Water heater switch

The GAS water heater switch enables *propane* operation of the water heater. The ELECTRIC water heater switch enables *electric* operation of the water heater.

The red Command Center switches illuminate when in the ON position.



Water Pump & Water Heater On/Off Switches

12-Volt Water Pump

Once activated, the water pump (*or on-demand pump*) will self-prime, and provide water. The water pump continues to run until approximately 45 lbs. of pressure is achieved, then shuts off. The water pump will automatically restart when pressure drops. Some cycling may occur, depending on the volume of water being released. The water pump has a built-in check valve to prevent water from back flowing.

Water pump filter (if so equipped) is a screen filter located on the inlet side. This reusable screen must be cleaned periodically.

Fresh Water Holding Tank

The fresh water tank can be pressure filled using the fresh water inlet or gravity filled using the gravity fill inlet. Plastic overflow tubes are plumbed into the fresh water holding tank to allow water to flow out of the water tank. Occasionally, you may see water coming from the overflow tubes (located underneath the RV) when the fresh water holding tank is filled. This is normal, and is caused by external circumstances, including the RV being parked on an incline, or the motion caused by starting or stopping the RV during travel.

- DO NOT cap, block or modify the fresh water tank overflow tubes in any way.
- If the overflow tubes are obstructed, enough water pressure can build up during the filling process to damage the plumbing system.

Water Pressure Regulator (Customer Supplied)

In some RV parks (especially in mountain regions), excessive pressure from water supply systems may be encountered.

- A *Water Pressure Regulator* (available for purchase from your RV dealer) will help to protect your plumbing system against damage from a high pressure water supply.

NOTICE

**BE CAREFUL
not to overfill the fresh
water holding tank.**

This can pressurize the tank, causing leakage & water damage, and also void your warranty.

DO NOT leave the tank unattended while filling.

NOTICE

Not using a water pressure regulator when using city water may cause the o-rings to fail. To prevent damage to the plumbing system or components when using the city water connection, a water pressure regulator rated for 40 lbs. is recommended.

NOTICE

The fresh water connection should be unplugged (i.e. the non-toxic drinking water hose disconnected) when the RV is left unattended for any amount of time.

If something would happen to the water system, this may help limit water damage to a smaller area.



DO NOT remove the following label from your RV.

WARNING

POTABLE WATER ONLY. SANITIZE, FLUSH AND DRAIN BEFORE USING. SEE INSTRUCTION MANUAL. FAILURE TO COMPLY COULD RESULT IN DEATH OR SERIOUS INJURY.

LD-101

Fresh Water Connections

There are two types of direct exterior fresh water connections in your RV: The city water fill is typically used at a campground when there is access to an external, pressurized potable water source. The gravity water fill is generally used to fill the fresh water tank when dry-camping.

To use the city water fill:

1. If needed, sanitize the RV water system
 - See **page 101**, *Sanitizing the Fresh Water System*.
2. Attach a non-toxic drinking water hose to the city water inlet.
3. Adjust the *City Water Control Handle* (blue lever):
 - **Select CITY WATER or FRESH TANK FILL BEFORE turning on the water supply.**
 - **To prevent harm to the valve, when water pressure is turned on, DO NOT adjust the City Water Control Handle.**
 - a. To fill the fresh water tank for use while dry camping, turn the city water control handle as shown below:



- b. For normal city water use at a campground, turn the city water control handle as shown below:



City Water Inlet

4. Turn ON the water at the water source.
5. Enter the RV and open the cold water supply faucets to bleed air from the water lines. When the water lines are nearly full, you may experience some *air pockets*. Allow them to escape before closing the cold water supply faucets.
6. The supply lines and faucets will fill, followed by the water heater.

To disconnect the city water fill

1. Shut OFF the water at the water source.
2. Disconnect the non-toxic drinking water hose.

Dry camping

- Fill the *Fresh Water Tank* BEFORE camping.
- Turn ON the *Water Pump Switch* to use the water system.

! WARNING

If you smell propane gas, STOP immediately!

Follow the procedures listed in the Propane System section of this manual before attempting to operate the water heater.

! WARNING

Hydrogen gas may result if you have NOT used the water heater for two weeks or more.

HYDROGEN GAS IS EXTREMELY FLAMMABLE.

To reduce the risk of injury under these conditions, open the hot water faucet for several minutes at the kitchen sink before you use any electrical appliance connected to the hot water system.

If hydrogen is present, you may hear what sounds like air escaping through the pipe as the water begins to flow. Hydrogen gas may be present even after water has been drained from the water heater tank.

Open the faucet at the sink and allow the system to vent for five to ten minutes.

DO NOT smoke or have any open flame near the open faucet while venting.

On DSI water heater models, make sure the switch is OFF.



Important NOTE: for proper operation of the water heater:

Any high altitude deration or other adjustments MUST BE REVERSED when you return the RV to lower elevation (*below 4500 feet*).

Water Heater

Read all safety and operating information provided here and in the manufacturer's manual before attempting to activate the water heater. The water heater is designed to heat water quickly and efficiently. It's temperature is preset by the manufacturer. Your RV's water heater is turned ON & OFF on the *Monitor Panel*.

DO NOT operate the Water Heater while empty. This can result in damage to the tank and/or controls that is NOT covered under the warranty.

- CHECK that the *Water Heater* is filled with water before use;
- ALWAYS open both the hot and cold water faucets when filling the fresh water tank to allow air pockets to be forced out of the water heater.

Draining and winterization

- If the RV will be stored over the winter, the *Water Heater must be drained* to prevent damage from FREEZING.
- When WINTERIZING, it is recommended to **bypass the Water Heater and remove the Anode Rod**, particularly if introducing RV antifreeze into the plumbing system.

Odor from the hot water system

The running water from some fresh water sources may have a *rotten egg* smell. This is known as *sulfur water*. The odor is caused by Hydrogen Sulfide gas (H₂S) in the water, usually the result of bacteria or chemical action. Generally, sulfur water is not harmful, only unpleasant to smell. **Hydrogen Sulfide (rotten egg) odor is not a service problem.**

See **page 164-165**, *Basic Troubleshooting, Water Heater*. Also refer to the water heater manufacturer's owner manual for details on flushing to remove unpleasant odor.

High altitude deration

Your water heater is designed to work at elevations up to 4500 ft. above sea level. At higher altitudes there is less oxygen in the air. An inadequate supply of oxygen causes the air-fuel mixture to be out of sync, which compromises combustion and can produce Carbon Monoxide. At higher elevations, the water heater may require **derating** (a modification to compensate for the lack of oxygen in the air). If the water heater is not properly derated, poor efficiency in heating the water may occur due to incomplete combustion. You may also notice pilot outage caused by burner lift-off or sooting from a yellow burner, indicating the possibility of carbon monoxide.

For proper change out of the orifice (**derating**) consult with a local propane company, your dealer, or the water heater manufacturer.

Anode Rod Protection (if so equipped)

The tank of the *Suburban* water heater is protected by a magnesium or aluminum *Anode Rod*. The rod absorbs the corrosive action of hot water to prolong the life of the tank. Through normal use, the anode rod will deteriorate. If water contains high levels of iron and/or sulfate, an anode rod will deteriorate faster; requiring more frequent replacement. The water heater manufacturer recommends that the anode rod be replaced annually or when consumption / weight loss is greater than 75 %. *See the photo at the bottom of the page.*

Operating the water heater without the proper anode rod protection will decrease tank life and will void the manufacturer's warranty. To extend the anode life, drain the water from the water heater tank whenever the RV is not being used. Avoid any extended time of non-use with water in the tank.

When replacing the anode rod, use a pipe thread sealant that is approved for potable water (such as Teflon Tape) on the threads of the anode rod to prevent a water leak. Proper application of a thread sealant will not interfere with the anode's tank protection.

Pressure & Temperature Relief Valve

The *Pressure and Temperature Relief Valve* (P & T Valve) is a safety requirement for all water heaters. As cold water is heated, pressure in the water heater tank increases. The P & T Valve will release any unsafe pressure from the water heater tank.

It is normal for a small quantity of water to also be released from the P & T valve during the heating cycle. To reduce water dripping from the P & T relief valve:

- **Maintain an air pocket at the top of the water heater.** (refer to the manufacturer's manual).
 - This air pocket forms in the tank by design.
 - Everyday use of your water heater will reduce this air pocket over time.

If the weeping persists, consult your dealer or a service agency authorized by the water heater manufacturer.

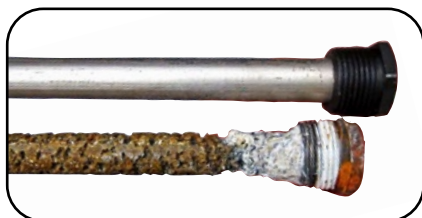

Brand New Anode Rod (top)
Corroded Anode Rod (bottom)

On/Off Switch
Anode Rod

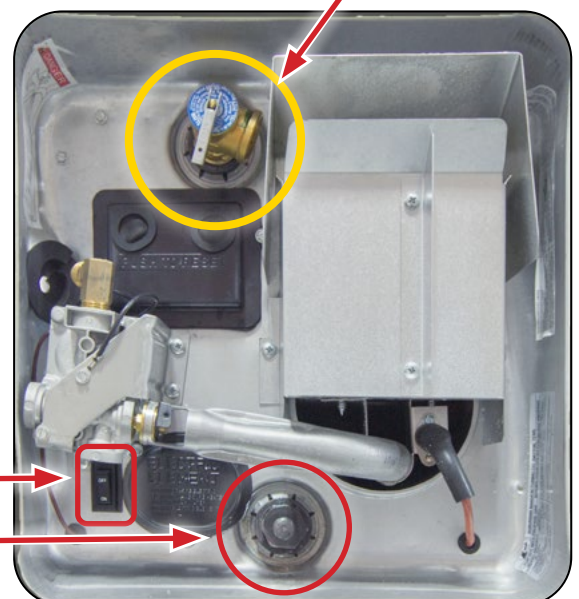

Pressure and Temperature Relief Valve

WARNING

Water temperatures over 125°F (49°C) can cause severe burns instantly or even death from scalds.

BE CAREFUL WHEN USING HOT WATER.

ALWAYS test the water temperature BEFORE showering or washing.

WARNING

DO NOT replace any **component part** with an **accessory part** that is not authorized by the water heater manufacturer, such as an *add-on* electric heating element.

Such items are not approved to be installed and could create an unsafe condition and will void all warranties.

Exterior Water Heater Door

(see photo below)

If the water heater does not work, make sure the power switch is in the ON position.

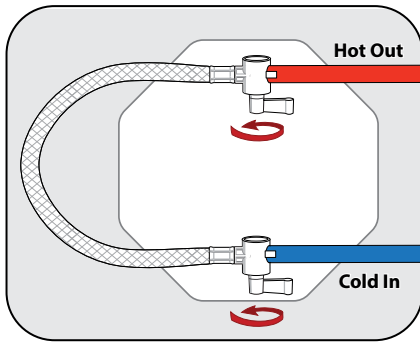

Water Heater Bypass Valves
(Bypass Position Shown)



Normal Use Positions



Bypass Positions

Water Heater, Continued

Water heater bypass

The water heater bypass uses two (2) valves, located on the back side of the water heater.

Also see **page 104**, *Water Heater Bypass Valves*.

- When camping, use the **Normal Use** position. TURN BOTH bypass valve handles towards the water heater as shown:

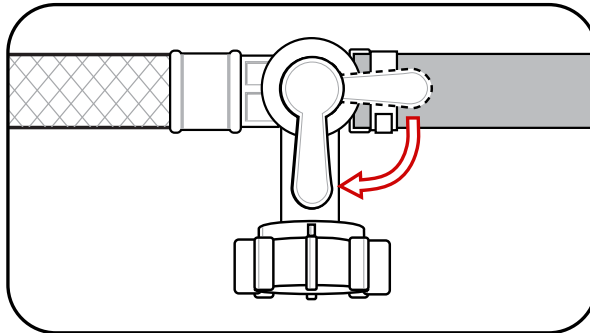

- When *Winterizing or Sanitizing*, use the **Bypass** position. TURN BOTH bypass valve handles towards the hot & cold water lines as shown:

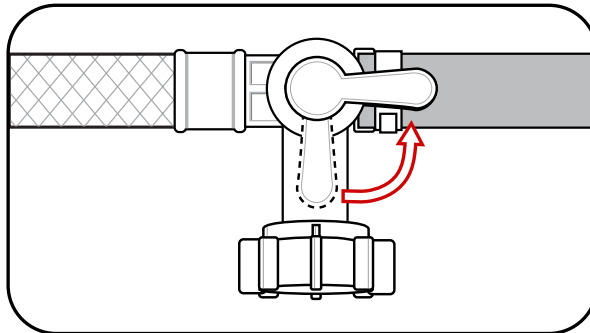

Bathroom Shower

Unlike your home, the RV does not contain a water pressure balance valve. When the shower is in use, DO NOT run any other water until shower is finished. Air may need to be bled out of the plumbing lines before a steady stream of water flows.

1. Keep aware of the water heater and holding tank capacities. All water used, will drain through the plumbing lines into the *Grey Water Holding Tank*.
2. CHECK that the *Water Heater* is turned ON, and
 - ALLOW sufficient time for the water to heat.
 - **If dry camping**, TURN ON the *12-volt Water Pump*.
3. Turn ON the hot and cold knobs, and ADJUST the water temperature *before* showering.

4. To conserve water while showering, wet down & turn OFF the water while using soap, *then* rinse.
5. When shower is finished, shut OFF the hot and cold knobs.
 - There is no *Shut-Off Valve* for the showerhead; shut-off is at the hot and cold knobs only.
 - The showerhead may still drip slightly after use, even in the OFF position. **This is normal.** *It does NOT indicate a leak or defect.*

Maintenance

The shower walls in your RV are made of *plastic*. **Clean with a mild detergent soap and warm water ONLY.**

- DO NOT use gritty or abrasive particle soaps or scouring compounds to clean the plastic.
- *Please also refer to the manufacturer's manual.*

Faucets

The faucets inside your RV operate much the same way as the faucets in your home.

- CHECK that the amount of water available is sufficient, and **If dry camping**, Turn ON the *12-volt Water Pump*.
- To OPEN the faucets, turn ON the hot and cold knobs, *then* ADJUST the temperature to your comfort level.
- CLOSE the faucets when a sufficient amount of water is released.

Exterior Spray Port (If So Equipped)

On most floorplans a quick-connect spray port is found at the *Universal Docking Station* for washing /rinsing outside your RV.

To use: Attach the supplied quick-connect hose and sprayer to your spray port.

1. CHECK that the *Water Heater* is turned ON and allow sufficient time for the water to heat.
 - **If dry camping**, TURN ON the *12-volt Water Pump*.
2. Turn ON the hot and cold knobs (if equipped) *then* adjust the water temperature as desired.

When finished: Turn OFF the hot and cold knobs (if equipped)

- Disconnect the quick connect hose and drain any excess water from the hose and sprayer nozzle.



Exterior Spray Port

NOT a Potable (Drinking Water) System

This Spray-Away unit should be drained for transport, storage, or if freezing weather is expected.

To drain:

1. Turn OFF water supply lines to Spray Away unit.
2. REMOVE spray nozzle from coil hose and insert hose into brass quick connect.
3. OPEN hot and cold valves if this unit has them.
4. HOLD open end of the hose near ground and drain system.
5. DISCONNECT hose when not in use.

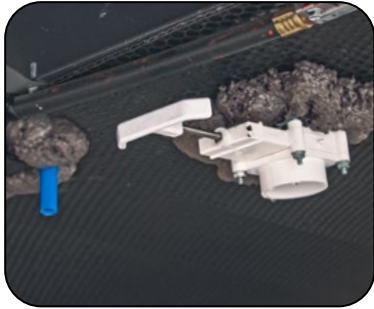

Fresh Water Holding Tank Gate Valve, located under the RV

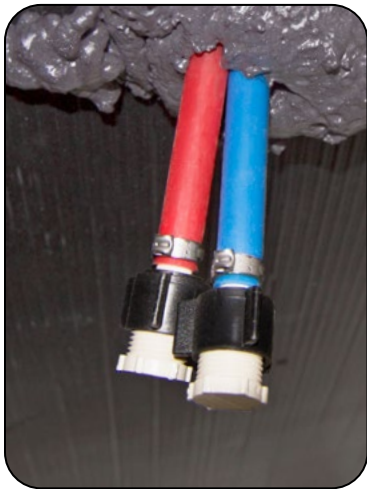

Low-Point Drain Valves located under the RV



Draining Positions

Draining the Fresh Water System

The low-point drain valves release water in the supply lines by opening the valves and all faucets. The water heater has its own drain plug. To drain the permanent fresh water holding tank and supply lines:

1. OPEN all faucets.
2. OPEN the *Fresh Water Holding Tank Gate Valve*. This is the white T-handle located under the RV, close to the axles. *See Photo, left.*
3. REMOVE the caps from the red and blue *low point drains*.
4. DRAIN the sink by removing the drain cap.
5. Turn ON the water pump and allow it to run as needed.
6. To drain the Water Heater use the **Normal Use** Valve Positions
 - TURN BOTH *bypass valve handles* towards the water heater as shown:

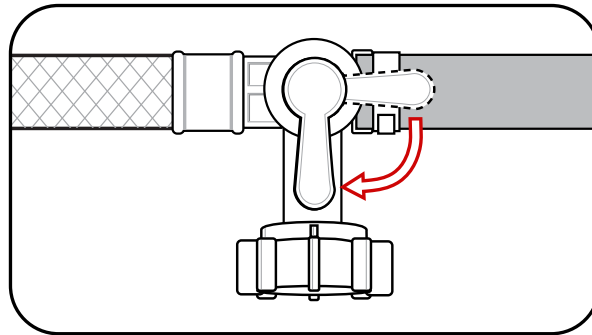

7. ALWAYS use the water heater **P & T Valve** (*Pressure and Temperature Valve*) to relieve any water pressure, BEFORE removing the water heater drain plug.
 - Even a small amount of water pressure may cause water to spray out when the drain plug is removed.
 - *See Photo, on page 97*
8. REMOVE the water heater **drain plug**.
 - AFTER the water heater is finished draining, REPLACE the drain plug.

After draining the Fresh Water System:

EMPTY the grey and black water holding tanks at an appropriate facility or according to local public codes. It is normal for some water to remain in the tanks after draining.

See **page 108**, *Emptying the Black & Grey Water Tanks.*

Sanitizing the Fresh Water System

Use the following procedures to sanitize your Fresh Water System (*or Potable Water System*) when it is new, becomes contaminated, or has not been used for a period of time.

Before you begin:

- TURN BOTH water heater bypass valve handles to the **Bypass** position.
 - See **page 98**, *Water heater bypass*.

To sanitize the fresh water tank & fresh water system:

- PREPARE a ***Chlorine Solution** using one (1) gallon of water and one-quarter (1/4) cup of household bleach (5% Sodium Hypochlorite solution).
 - PREPARE approximately one (1) gallon of solution for every fifteen (15) gallons of holding tank capacity.
1. ACCESS your Water Pump. (*Location varies by floorplan*)
 - See **Winterizing Steps 5a-c**, on **page 102-103**.
 2. REMOVE the re-usable cap from the *Suction Line*. (*SAVE the cap for step 13.*)
 3. PLACE the *Suction Line* into the container of ***Chlorine Solution**.
 4. OPEN the *Winterization Valve* as shown on **page 105**.
 5. Turn ON the *12-volt Water Pump*.
 6. OPEN the ***hot** water line at each faucet. (*Kitchen, Lavatory, Shower, & Outside Faucet/Spray Port*)
 - CLOSE each ***hot** water line faucet when ***Chlorine Solution** begins to flow continuously.
 7. REPEAT **Step 6** with the ***cold** water lines on all faucets. It is also important to run ***Chlorine Solution** through the *Toilet* and the *Sink/Shower Drains*.

When you are done adding ***Chlorine Solution**

8. REMOVE the *Suction Line* from the container of ***Chlorine Solution**.
9. REPLACE the reusable cap (if so equipped) on the *Suction Line*.

To remove strong chlorine odor/taste that may remain:

10. PREPARE a ***Vinegar Solution** of one (1) quart vinegar to five (5) gallons water.
 - PREPARE approximately one (1) gallon of solution for every fifteen (15) gallons of holding tank capacity.
11. REPEAT steps 2-9 above with the ***Vinegar Solution**.



Before you begin Sanitizing:

If you have installed an aftermarket Water Filter, make sure that it is set to the **bypass** position.



As an option, several water system sanitizing solutions are also commercially available.

These should be used as directed on the package

 **WARNING**

Both automotive antifreeze (ethylene glycol) and windshield washer anti-freeze (methanol) are poisonous.

NEVER use these products in your fresh water system. They are harmful and may be fatal if swallowed.



It is important for you to read all instructions and understand each step *before* starting the winterization process.

- It may be easier to winterize the RV with a second person to assist you.

If you still have questions or concerns, contact your dealer for assistance.



Before you begin Winterizing:

If you have installed an aftermarket Water Filter, make sure that it is set to the **bypass** position.

Winterizing the Plumbing System

Preparing your RV for storage is very important in climates that experience cold weather. Follow the steps listed below at the end of the camping season.

See **page 105**, *Winterization Valve*.

- ALWAYS winterize the fresh water system of your RV **BEFORE** exposure to temperatures at or below 32°F (0°C).
 - *Damage to the water supply lines or water heater due to freezing is not covered under warranty.*
- **Winterize with RV Antifreeze ONLY**, no other products should ever be added to your fresh water system.
 - Make sure to have enough RV antifreeze to winterize all fresh water lines. *Several gallons may be required.*
- **BEFORE Winterizing, the Black Water, Gray Water & Fresh Water plumbing systems MUST all be emptied.**
 - **See page 108 & page 100.**

1. LEVEL the RV.
2. Turn OFF the *Water Heater 12-volt and 120-volt interior control switches*.
3. TURN BOTH water heater bypass valve handles to the **Bypass** position.
 - *See page 98, Water heater bypass.*
 - *If you have installed an aftermarket water filter, make sure that it is also set to the bypass position.*
4. OPEN the *Fresh Water Holding Tank Gate Valve*, and CLOSE both *low point drains*.
5. ACCESS your Water Pump. (*Location varies by floorplan*)
 - The **Winterize Valve & Suction Line** are found on the intake side of pump.
 - a. **If pump is located under the Dinette Bench:** REMOVE cushions and LIFT seat panel.
 - b. **If pump is located behind the Universal Docking Station:** UNSCREW & REMOVE the access panel located in your pass-through compartment.

- c. **If pump is located behind the Kitchen Drawers:**
REMOVE the three drawers from the base cabinet:
- i. PULL OUT the drawer until it stops.
 - ii. LOCATE the plastic drawer release clips on the right and left sides of the drawer, *then*
 - iii. *At the same time*, gently PUSH and HOLD down both plastic drawer release clips.
 - iv. Continue to PULL the drawer towards you and remove it from the drawer guides.
 - v. REPEAT **steps (i - iv)** to remove the remaining kitchen drawers.
6. REMOVE the re-usable cap from the *Suction Line*.
(SAVE the cap for step 13.)
 7. PLACE the *Suction Line* into a container of RV antifreeze.
 8. OPEN the *Winterization Valve* as shown on **page 105**.
 9. Turn ON the *12-volt Water Pump*.
 10. OPEN the ***hot** water line at each faucet.
(*Kitchen, Lavatory, Shower, & Outside Faucet/Spray Port*)
 - CLOSE each ***hot** water line faucet when RV antifreeze begins to flow continuously.
 11. REPEAT **Step 10** with the ***cold** water lines on all faucets. It is also important to run RV antifreeze through the *Toilet* and the *Sink/Shower Drains*.

When you are done adding RV antifreeze

12. REMOVE the *Suction Line* from the container of RV antifreeze.
13. REPLACE the reusable cap (if so equipped) on the *Suction Line*.
14. BLOW OUT the black tank flush line at the outside connection with compressed air (max 70 PSI).
15. *To prevent staining*, CLEAN any RV antifreeze from the sinks, shower (or tub), and toilet using a soft, dry cloth.

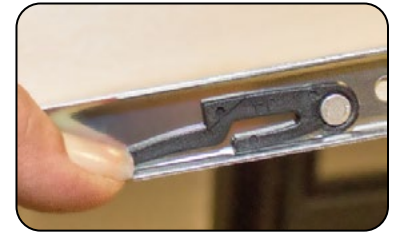

Drawer Release Clips

Water Heater Bypass Valves

Normal Use:

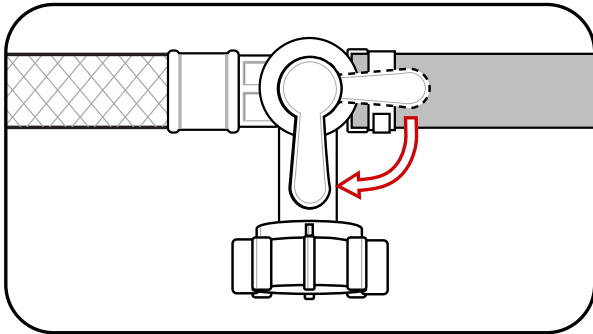

TURN BOTH bypass valve handles towards the water heater.

Bypass- Sanitizing / Winterizing:

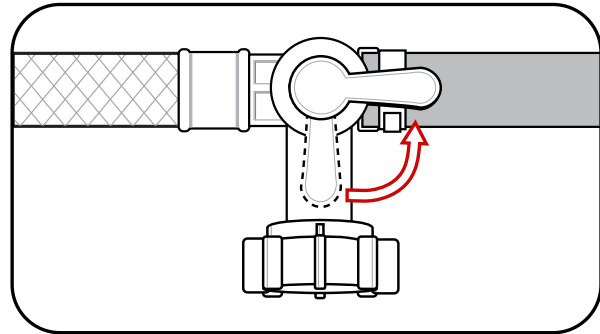

TURN BOTH bypass valve handles towards the hot & cold waterlines.

* *The water heater bypass valves are found on the back side of the water heater. See page 98, Water heater bypass.*

Universal Docking Station

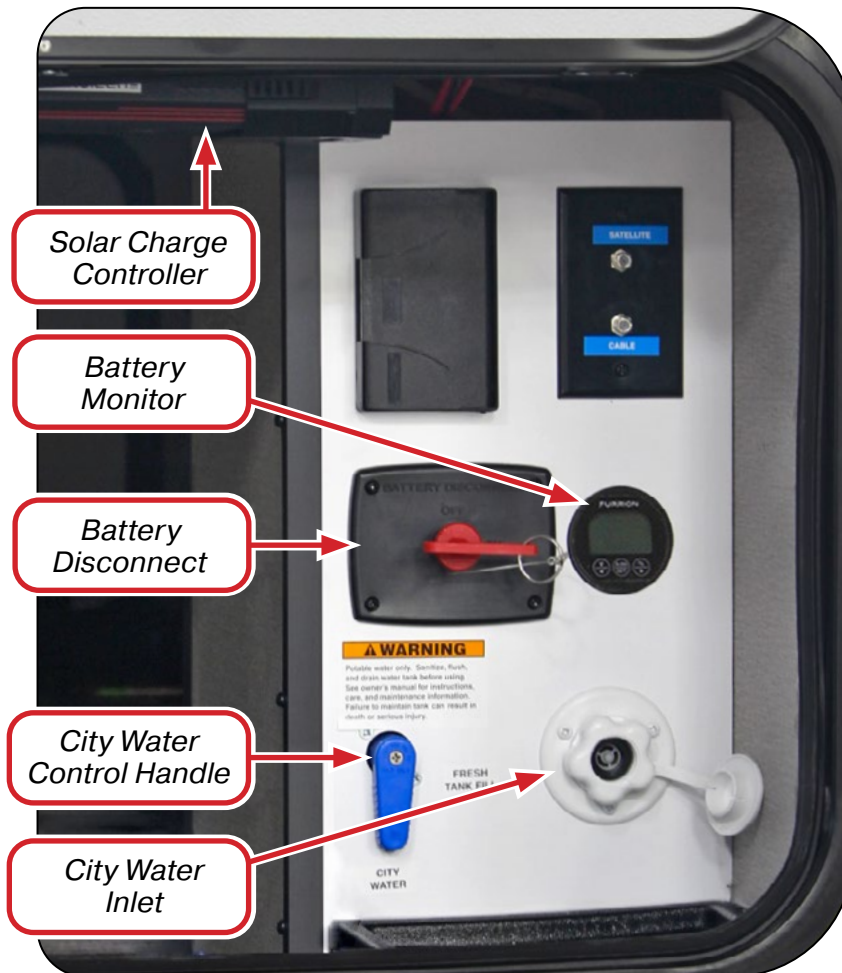

Winterization Valve

ADJUST both of the *Water Heater Bypass Valve Handles* to the correct setting (as shown left).

Normal Use:

1. TURN the *Winterization Valve* to the CLOSED position.

Winterizing / Sanitizing:

1. TURN the *Winterization Valve* to the OPEN position.
2. LOCATE the *Suction Line* & REMOVE the cap.
 - **Winterizing** - PLACE the *Suction Line* into the container of **RV antifreeze**
 - **Sanitizing** - PLACE the *Suction Line* into the container of **Chlorine Bleach/Water mixture**.
3. TURN ON the *Water Pump*.
4. OPEN all faucet fixtures individually until RV antifreeze is present. (*Kitchen, Lavatory, Shower, Stool, & Outside Faucet/Spray Port*)

See **page 101**, *Sanitizing the Plumbing System*.

See **page 102-103**, *Winterizing the Plumbing System*.

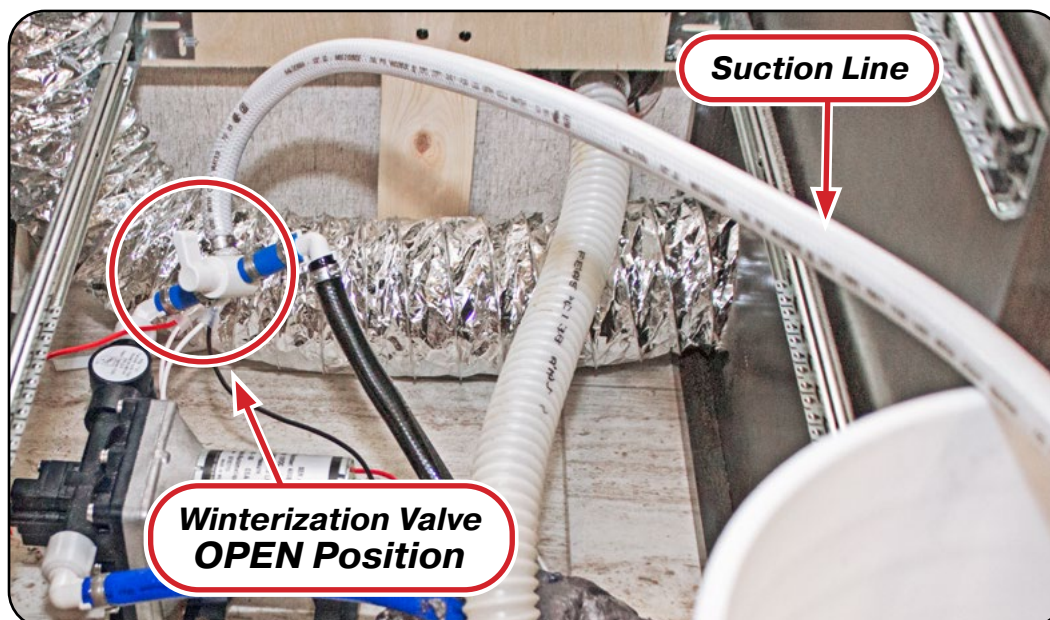
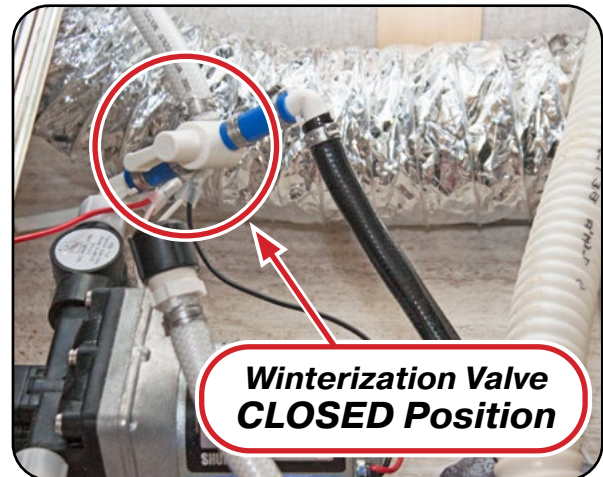

 **WARNING**

NEVER travel with full black or grey water holding tanks. This not only wastes your fuel but depending on the location of the tank(s), it can affect your tow vehicle handling characteristics.

NOTICE

DO NOT add automotive antifreeze or caustic chemicals such as laundry detergents into the holding tanks. Although these products may have a deodorizing effect, they may damage the plastic and rubber parts of the plumbing system or the components.

Black Water & Grey Water Systems

Your RV toilet drains into the *Black Water* (sewage) holding tank. The sinks and shower drain into the *Grey Water* (waste water) holding tank.

- ALWAYS empty the black and grey water holding tanks before traveling to avoid carrying unnecessary weight.
- If you are dry camping and cannot immediately empty your holding tanks, reduce your vehicle speed until you reach a dumping station.
- The *Cargo Carrying Capacity* of your RV is based on **empty** holding tanks. Any additional weight for the contents of your holding tank(s) **reduces** your *Cargo Carrying Capacity* by the same amount.

Traveling with your holding tank(s) full could result in the following conditions:

- Reduced available cargo capacity.
- Exceeding individual tire ratings and/or the GAWR or GVWR.
- Potential damage to suspension components, such as springs, tires and axles.
- Reduced hitch weight, if your RV holding tank(s) are located behind the axles.
- Trailer sway and other handling difficulties, as a result of the hitch weight being too light.

Toilet

Your RV toilet uses only one to three quarts (*or 1-3 liters*) of water per flush, about *ten times less* than a residential toilet. Additional water may be needed to flush solids from the drain line into the holding tank.

- **ALWAYS continue to run water for an extra 10-15 seconds after flushing.**
- **NOT flushing with enough water, can result in clogged pipes or tanks.**

To help prevent a toilet blockage:

- **Before use:** FLUSH the toilet several times, releasing enough water to cover the bottom of the holding tank.
- ALWAYS maintain four to six inches (10-15 cm) of water in the toilet for better performance.
- ALWAYS use RV grade, single-ply toilet paper.
- NEVER flush *any* foreign objects down the RV toilet (*hygiene products, cleaning wipes, paper towels, diapers*)

Cleaning and maintenance

- CLEAN the toilet regularly.
- DO NOT use undiluted chlorine or caustic chemicals in the RV toilet (*laundry bleach, chemical drain openers*).
 - These products will DAMAGE the seals in the toilet and dump valves.
- Applying petroleum jelly to a *sticky* toilet ball valve will provide waterproof lubrication without damaging the seals.

Black & Grey Water Holding Tanks

Black water (sewage) tank preparation

- Adding an RV holding tank deodorizer (customer supplied) will help break down tank contents and control odors.

DO THE FOLLOWING

- **BEFORE the first use, and AFTER dumping the holding tanks** (*unless you are winterizing your RV*):
 1. RELEASE one to two quarts (1-2 liters) of water into the toilet bowl.
 2. ADD the tank deodorizer (customer supplied) to your black water tank per the packaging instructions.
 3. FLUSH the toilet and allow at least two gallons (8 liters) of water to flow into the holding tank.

Grey water (waste water) tank preparation

No special preparation is required. If needed, control odors from the grey water system by adding a small quantity of baking soda or RV holding tank deodorizer down the sink or shower drain.

NOTICE

It is important to prevent solid waste buildup. Follow the toilet manufacturer's instructions each time after emptying the black water holding tank.



Sewer cap must be securely in place while the vehicle is in motion.

Emptying the Black & Grey Water Tanks

The black tank and grey tank drain valves (*or dump valves*) are located near the *Sewer Outlet Connection*, under the RV on the off-door side, and/or in the utility center.

- **ALWAYS drain the black water holding tank FIRST.**
 - **THEN, drain the grey tank waste water to help rinse any solids from the sewer outlet and hose.**
1. Driving to a disposal site will normally loosen any accumulated waste solids from the sides of the holding tanks.
 2. To make drainage easier, LEVEL the RV.
 3. LOCATE the *Sewer Outlet Connection*,
 - REMOVE the sewer hose housing dust cap, *and*
 - ATTACH your sewer hose (customer supplied).
 4. PLACE the other end of the sewer hose into the approved dump station.
 5. OPEN the black tank dump valve by carefully **pulling** the handle out towards you.
 - CLOSE it by **pushing** the handle shut after the black water holding tank has drained.
 6. EMPTY each grey water holding tank (one at a time).
 - OPEN the 1st Grey Tank dump valve
 - CLOSE the valve after the tank has drained.
 - REPEAT for the 2nd Grey Tank.
 7. REMOVE, CLEAN and STORE the sewer hose.
 8. CLOSE the sewer hose housing dust cap.

When connected to a (campground) sewer drain

- Keep the *Black Tank Drain Valve* CLOSED until the holding tank is *at least* $\frac{3}{4}$ full. This should provide enough water to completely drain the holding tank.
- DO NOT leave the *Black Tank Drain* in the OPEN position.



Sewer Outlet Connection Is Located Under the RV on the Off-Door Side

Dump station locations

Dump station locations throughout the United States and Canada can be found on many websites and publications including Woodall's, Rand McNally Camp Guide, Good Sam Camp Guide, KOA Kampgrounds Camp Guide. Some gas stations also have dump stations.

If you need assistance with the purchase or installation of a sewer hose or hose extension, Please contact your dealer.

Vents & Vent Pipes

For the plumbing system to drain properly, the vents and vent pipes must release air from the grey and black water holding tanks. Always keep the exterior vent cap on the roof clear of any obstructions. In some models the vent pipe may be a *wet vent* allowing water to drain downward with air flowing upward in the same pipe.

Drain Pipes With Dry Sealing Valve

Your RV may be equipped with a dry sealing valve to prevent the escape of odors from your waste system and eliminate the need for P-traps. Should the RV drain piping system become clogged, a mechanical clean-out tool is used to open the drain pipe.

- **It is important to remove the dry valve before passing the clean-out tool through the piping.**
- **Passing a mechanical clean-out tool through the waterless valve may cause damage to the internal seal that may potentially allow sewer gases to escape to the RV interior.**

Drain Pipes With P-Traps

The drain pipes may be equipped with a *P-trap* installed to help prevent odors from escaping into the RV. **During travel, water from the P-traps may spill and permit odors into the RV.**

Adding water and using a RV approved deodorizing agent will dissolve the contents faster and keep the drain lines and tanks clean and free flowing. These chemicals are available at an RV supply store or your dealer.

NOTICE

Remove the waterless trap before using mechanical drain cleaning devices. Waterless trap can be damaged.

CAUTION

DO NOT use the tank flush valve unless the fullway termination valve (gate valve) is in the open position. This can result in an unsanitary condition leading to illness or personal injury.

NOTICE

When flushing the black tank, the gate valve must be open or damage may occur to the system.

Black Tank Flusher

The black tank flusher is designed to rinse the interior of the black (waste) tank. A separate water hookup is located on the off-door side.

To flush the tank after dumping:

1. Leave the sewer hose connected to the outlet pipe. Ensure that it is routed to the dump station inlet.
2. Attach a garden hose to the *black tank flusher inlet*. **DO NOT use your fresh water hose.**
3. Be sure the black tank gate valve is in the OPEN position.
4. Open the water supply to full pressure to flush tank.
5. When the water runs clear from the sewer hose, shut OFF the water supply and disconnect the garden hose from the water source.
6. DO NOT disconnect the hose from flush inlet UNTIL all water has drained from the system.

- **DO NOT add any check valves to this system.**
- **DO NOT leave a hose connected when not in use.**



Black Tank Flusher Inlet is located on the off-door side of the RV.

Propane System

The propane system includes the propane cylinders, propane regulator, hoses, piping and copper tubing lines to each gas appliance. Follow the manufacturer's instructions for each propane appliance and all safety precautions.

Maintenance

Although both Grand Design RV and your selling dealer carefully test the propane system for leaks, travel vibrations can loosen fittings. Have the RV's propane system checked at all connections soon after your purchase. System should also be checked when the propane tanks are filled for the first time, and again after 5,000 miles of travel.

Continue propane system checks by a qualified propane service representative (*at least once a year*) as part of your normal maintenance.

Propane Gas

In your RV, propane or LP (liquefied petroleum) is used by the stove, furnace, hot water heater and refrigerator.

- An unpleasant "*sulfur or rotten egg*" smell is added to propane to alert customers to leaks, which can create a safety hazard.

When a propane cylinder is low, there may be a different odor *like onions or garlic*, that may be mistaken for a gas leak. This odor will usually disappear when the cylinder is filled.

- *If the odor persists*, turn OFF the valve(s) and have the propane system inspected by your dealer or qualified propane service technician.



DANGER

IF YOU SMELL
PROPANE GAS
STOP!

Quickly and carefully perform the 6-step procedure in the red box at the bottom of this page.



DO NOT remove the following label from your RV:

⚠ DANGER
ALL PILOT LIGHTS, APPLIANCES AND THEIR IGNITORS (SEE OPERATING INSTRUCTIONS) SHALL BE TURNED OFF BEFORE REFUELING OF FUEL TANKS AND/OR PROPANE CONTAINERS. FAILURE TO COMPLY COULD RESULT IN DEATH OR SERIOUS INJURY.

⚠ WARNING
DO NOT FILL PROPANE CONTAINER(S) TO MORE THAN 80 PERCENT OF CAPACITY. FAILURE TO COMPLY COULD RESULT IN A FIRE OR PERSONAL INJURY.

⚠ CAUTION
THIS PROPANE PIPING SYSTEM IS DESIGNED FOR USE WITH PROPANE ONLY. DO NOT CONNECT NATURAL GAS TO THIS SYSTEM. Securely cap inlet when not connected for use. After turning on propane, except after normal cylinder replacement, test propane piping and connections to appliances for leakage with soapy water or bubble solution. Do not use products that contain ammonia or chlorine. LD-101

IF YOU SMELL PROPANE

1. **EXTINGUISH** any open flames, pilot lights and all smoking materials.
2. **DO NOT** touch electrical switches.
3. **SHUT OFF** the propane supply at the container valve(s) or propane supply connection.
4. **OPEN** doors and other ventilating openings.
5. **LEAVE THE AREA** until odor clears.
6. **Have the propane system checked and leakage source corrected before using again.**

**FAILURE TO COMPLY COULD RESULT IN EXPLOSION
RESULTING IN DEATH OR SERIOUS INJURY**

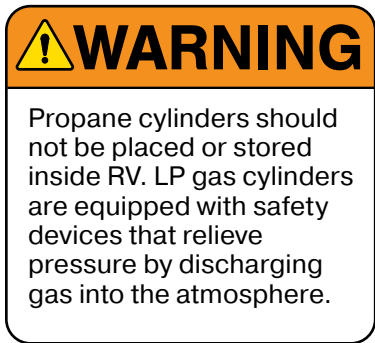

Propane Gas Cylinders

While under pressure in the cylinder, propane gas is compressed into its liquid form. Propane will not run through the appliances in its liquid state. As the fuel is released from the cylinder to operate an appliance, it changes from liquid to gas.

- **IMPORTANT:** Propane EXPANDS 1½ percent for every ten degree increase in temperature.
- **Sufficient space MUST be left inside container for expansion of gas during warmer weather.**

Propane cylinders (also referred to as LP bottles) are used for the storage and delivery of propane gas. Propane cylinders are filled by weight, expressed in pounds. For filling, a qualified propane facility is required, and cylinders must be removed from the RV.

When the propane system is not in use, the main shut off valve MUST be kept closed. To close the propane cylinder main shut off valve: **HAND TIGHTEN ONLY, do not use tools.** *Over-tightening may damage the interior seals on the cylinder valve seat.* If this type of damage occurs, the cylinder valve WILL NOT close properly.

DOT (Dept. of Transportation) Cylinders are the most common for use on RV trailers. DOT cylinders equipped with an OPD and ACME TYPE 1 service valve are identified by the triangular service valve knob.

- ALWAYS close the service valve and install a dust cap or plug when transporting or storing disconnected containers whether full or empty.

DOT cylinders are typically marked with “top” or an arrow indicating the correct orientation of the cylinder(s.)

- ALWAYS mount, store and transport the cylinder(s) in the position specified.
- ALWAYS securely re-install DOT cylinder(s) to the RV after they have been removed for filling or replacement.

The cylinders are equipped with an **Over-fill Protection Device** (OPD) designed to reduce the potential of overfilling. They are also equipped with an ACME service valve that is for connection of the TYPE 1 ACME pigtail hose assembly to the RV two-stage regulator. The TYPE 1 ACME pigtail hose assembly is a right-hand threaded, wrenchless connector that features a thermally sensitive sleeve and excess flow device.

Max output is 200,000 BTU/hr. It is used to connect propane cylinders to regulators, hoses and other fittings. It is not for use on gas grills and other low pressure devices.

Servicing or filling

Have the RV checked for leaks at the connections on the propane system soon after the purchase and the initial filling of each propane cylinder.

- **While the propane tanks are being filled, ONLY the qualified propane service technician should be near the RV. No one should be inside.**

When you have a new cylinder filled for the first time, make sure your propane supplier purges your new cylinder of trapped air. Otherwise, an improper mixture of gas and air will make it impossible to light your propane appliances. For best performance the new propane cylinder must be carefully purged before filling.

LP gas container overfill

NEVER allow your propane cylinder(s) to be filled beyond the maximum safe level marked on the cylinder. Your propane system is designed for gas vapor only. An overfilled cylinder could force *liquid* propane into the system, creating a hazardous condition.

Propane Leak Test

ALWAYS test for leaks with a solution of dish soap & water.

- Apply the solution with a spray bottle, to the outside of all gas line joints and fittings.
- If a leak is present, the soapy solution will bubble at the leak point.
- As a general rule, small bubbles indicate a small leak while large bubbles indicate a larger leak.

NEVER use a solution containing ammonia or chlorine when locating leaks.

- These products are corrosive to copper gas lines and brass fittings, which could result in deterioration of the copper and brass components.

If a leak is not fixed by tightening the connection, shut OFF the propane system valve(s) and immediately contact your dealer or a qualified propane service representative.

WARNING

BEFORE entering a propane or fuel service station make sure ALL pilot lights are extinguished.

- Shut OFF the gas to all appliances by CLOSING the Propane Gas Main Shut Off Valve.
- ALWAYS shut OFF any engine before refueling.
- DO NOT smoke, *and*
- DO NOT operate other ignition sources while refueling.

WARNING

If you suspect your propane container has been overfilled, contact your dealer or a qualified propane technician for assistance immediately.

DO NOT use or attempt to service an overfilled propane container yourself.

DANGER

Extinguish ALL flames.

NEVER use an open flame to check for leaks.

Failure to follow this warning could result in a fire or explosion resulting in serious injury or death.

WARNING

DO NOT check for leaks using products that contain ammonia or chlorine; these products can cause cracks to form on the metal tubing and brass fittings.

 **WARNING**

Test Propane Gas Alarm operation after the RV has been in storage, before each trip and at least once per week during use.

 **WARNING**

NEVER turn the 12-volt battery disconnect control to the OFF position and disconnect the battery cable to silence the alarm.

 **WARNING**

The pigtail hose **MUST** be installed to avoid tension or pulling stress at either end of the hose.
Keep the pigtail hose away from sharp edges of the cylinder collar, rigid corners, walls, doors or other compartment structures including the cover.

 **WARNING**

Ensure that all fasteners are secured before traveling.

Propane Alarm

Your RV is equipped with a propane alarm. Please read and follow the component manufacturer instructions supplied in your *Owner Information Package*.

*For detailed information on this alarm, See **page 37-39**, Propane (LP) Gas Alarm.*

Installing the Propane Cylinders

The position of the propane cylinder(s) and hoses is critical to proper operation and propane flow. FOLLOW these instructions to make sure your propane container(s) are connected properly.

1. CHECK that all the RV appliances are shut OFF.
2. CHECK that each LP cylinder *Shut-Off Valve* is CLOSED.
3. PLACE the *LP Cylinders* on the LP cylinder brackets or LP tray (if so equipped) located on the trailer A-Frame, and secure them.
4. The two (2) 3/8" low-pressure pigtail hoses should be attached one to each side of the auto changeover regulator.
5. CHECK to make sure the LP regulator is mounted on the housing so the vent is pointed downward.
 - *The LP Regulator Vent must be unobstructed at all times.*
 - Also CHECK the vent opening after freezing rain, sleet, or snow to make sure that ice has not formed in the vent.
6. ATTACH the TYPE I end of each pigtail hose to each LP cylinder.
7. ATTACH the main supply hose from the regulator to the brass manifold fitting in the frame of the trailer. The swivel brass nut on the main hose will be your final attachment.

Remember each time the propane container is removed:

- CHECK that ALL fittings are tight.
- CHECK that ALL connections are tested with a *Propane Leak Detector* (or soapy water solution).
- OPEN the main shut-off valve on the LP cylinder **very slowly**. This avoids *propane freeze up*, caused by a fast rush of propane to the excess flow valve.

- If you do experience a *propane freeze up*, CLOSE the main valve and wait at least fifteen (15) minutes before trying again. *For more information, refer to the regulator manufacturer's operator manual.*
- Listen carefully. A *hissing* sound longer than one second, may indicate a propane leak. If you suspect that there is a leak, close the shut-off valve, *then* contact your dealer or qualified propane technician for repair assistance.
- Replace all protective covers and caps on the propane system after filling. Make sure the valve is closed. Install the LP bottle cover and use the bungee cord at the bottom to secure it in place for travel or storage purposes.

Propane Regulator

Your Momentum M.A.V. TT is equipped with an *automatic* two-stage regulator. Its sole function is to reduce the *pressure* from the propane containers to a safe and consistent low operating pressure in the propane system.

The first stage reduces the container pressure to 10-13 lbs. The second stage further reduces the 10-13 lbs. of pressure to an operating pressure of 11" W.C. (water column) or 6.35 oz. of outlet pressure to your appliances.

For optimum performance, the 2nd stage will need to be adjusted by your dealer (or qualified propane service technician) using a properly calibrated manometer.

- If the pressure is **too high**, the safety and performance of the propane system will be affected.
- If the pressure is **too low**, the LP appliances will NOT operate correctly.

With both cylinders full of propane, turn the lever on the regulator towards the cylinder you wish to use first. This will now be the *supply* cylinder and the other the *reserve*.

Slowly open both cylinder valves. When the *supply* cylinder is empty, the indicator will change to red. Now turn the regulator lever to the *reserve* cylinder side. You may now remove the empty cylinder to have it refilled without interrupting the flow from the full bottle. After filling the cylinder, connect the pigtail hose and slowly open the bottle valve.

WARNING

All propane connections should be checked periodically as vibrations from travel may cause them to loosen.

Failure to check connections could lead to a propane leak resulting in a fire or explosion that could cause serious injury or death

WARNING

Propane regulators must always be installed with the regulator vent facing downward. Regulators that are not located in baggage compartments have been equipped with a protective cover.

Make sure the regulator vent faces downward and (if applicable) the cover is in place to minimize vent blockage that could result in excessive gas pressure causing fire or explosion.



Automatic Change Over Propane Regulator

Propane System Hoses, Tubes, Pipes & Fittings

The hoses, pipes, tubes and fittings used in your propane system are designed to withstand pressures exceeding those of the propane system. However, because environment and time can both contribute to the deterioration of these components, they must be inspected for wear at regular intervals. Be sure to inspect the hose before each season and when having the tank refilled. Look for signs of deterioration such as cracks or loss of flexibility. When replacing the hose or other propane components, always replace them with components of the same type and rating (check with your dealer).

Fittings are used to connect the various system components to each other. The P.O.L. fitting at the end of the propane supply hose is made of brass so that pipe sealants are not necessary to prevent leaking. It also has a left-handed thread, which means that it is turned clockwise to remove, and counter-clockwise to tighten. The P.O.L. fitting has been designed to help restrict the flow of LP gas in the event of a regulator failure or hose malfunction.

Cooking With Propane

Unlike homes, the amount of oxygen supply is limited due to the size of the RV. Proper ventilation when using the cooking appliance(s) will help you avoid the danger of asphyxiation.

For additional safety instructions, See page 119, Appliances.

Traveling With Propane

BEFORE towing your RV,

1. ALWAYS check that the propane bottles are properly fastened in place, *and*
 - TURN OFF the gas at the LP bottle.
This disables all gas appliances and pilot lights.

DO NOT operate Propane System while the RV is in motion.

- Some states prohibit propane appliances to be operated during travel (especially in underground tunnels).
- Make sure to know the laws for the areas where you travel.

Using The Propane System

After the RV is completely set up and you are prepared for camping enjoyment, use the following steps for propane operation:

1. CLOSE ALL burner valves, controls and pilot light valves.
2. **OPEN the propane tank's main valve VERY SLOWLY.** This avoids a fast rush of propane vapor through the excess flow valve which can cause a *propane freeze-up*.
 - If a *propane freeze-up* occurs, CLOSE the main valve and wait 15 minutes before trying again.
3. LISTEN carefully as propane begins to flow.
 - If a hissing noise is heard for more than one or two seconds, CLOSE the main valve and contact your dealer to have your propane system tested.
4. LIGHT the appliances ONLY as directed in the appropriate manufacturer manual (found in your Owner Information Package).

BEFORE using the propane system, make sure that you read and understand ALL instructions and safety requirements. The Owner Information Package contains operator manuals for the various appliances hooked to your propane system.

If you have additional questions or concerns, Consult with your dealer and/or the specific manufacturer.

WARNING

DO NOT operate the gas appliances while your RV is in motion.

Unpredictable wind currents may be created, and cause flame reversal in the water heater burner tube, which could result in fire damage.

This could also activate the water heater's *Thermal Cut Off Fuse* and completely shut down the water heater until the thermal cut off fuse is replaced.

Calculating Propane Use

Your Momentum M.A.V. TT's furnace, refrigerator, water heater and range (if applicable) all may use propane to operate. Use the BTU rating of each appliance to determine how long your propane supply will last. Propane consumption depends on their individual use and the length of time operated.

Most RV gas appliances are operated intermittently. Unless there is heavy use of hot water, the water heater consumption of propane is minimal. During cool temperature or high wind conditions, furnace consumption can be extremely high.

To calculate your propane supply, take the BTU ratings for your propane appliances and divide that into the BTU availability. Each gallon of propane (3.86 liters) produces about 91,500 BTUs (46,514 kilojoules) of heat energy.

Average Propane Consumption

Appliance	Average BTU Consumption/Hr.	Kilojoules/Hr.
Water Heater	8,800	9,280
Refrigerator	640-1,200	680-1,270
Furnace	16,000 - 35,000	16,880 - 36,930
Range w/ Oven	7,100	7,490
Range - Rear Burner	6,500	6,860
Range - Front Burner	9,000	9,490

Appliances

BEFORE using your RV appliances:

Please read and understand the manufacturer owner manual for each specific component.

- **Follow all instructions, warnings, & safety alerts found in the manufacturer owner manuals when using the appliances in your RV.**
- **If you have any questions contact your dealer or Grand Design RV Customer Service.**

These manuals are found in your Owner Information Package.

If there have been modifications or replacements made to your RV, then these instructions may not apply. Please contact the service center or technician who performed the modifications or substitutions if assistance is required.

Microwave

- Sufficient 120-volt power **MUST** be available **BEFORE** operating the microwave.
- To prevent damage, **ALWAYS** make sure that the microwave turntable is secured prior to traveling.

12 Volt Refrigerator

An RV refrigerator is not intended for quick cooling or freezing. For best results, stock with food that is *already* cold or frozen.

- Arrange food items so that air is allowed to circulate freely.
- **DO NOT** cover the shelves with paper or plastic.
- Keep the area at the back of the refrigerator clean and free of debris.
- For optimum efficiency and performance, the refrigerator should be checked at least twice a year as part of routine maintenance.

Oven

- **DO NOT use the oven as a storage area.**
- The propane gas oven ignites using a pilot light.

DANGER

**IF YOU SMELL
PROPANE GAS
STOP!**

Quickly and carefully perform the 6-step procedure below:

DANGER

IF YOU SMELL PROPANE

1. Extinguish any open flames, pilot lights and all smoking materials.
2. Do not touch electrical switches.
3. Shut off the propane supply at the container valve(s) or propane supply connection.
4. Open doors and other ventilating openings.
5. Leave the area until odor clears.
6. Have the propane system checked and leakage source corrected before using again.

**FAILURE TO COMPLY COULD
RESULT IN EXPLOSION RESULTING
IN DEATH OR SERIOUS INJURY. LD-101**

DANGER

DO NOT use gas cooking appliances for comfort heating.

This may lead to carbon monoxide poisoning, which can lead to death or serious injury.

WARNING

DO NOT use portable fuel burning equipment (i.e., wood and charcoal grills or stoves) inside the RV. Use of these items inside an RV may cause fires or inability to breathe.

WARNING

DO NOT cover the oven vent openings while the oven is in operation. Restricting the flow of combustion air will create an asphyxiation hazard.

 **WARNING**

DO NOT turn the gas range burner controls ON and allow propane gas to escape before lighting.

 **WARNING**

During and after use, DO NOT touch or let clothing or other flammable material come in contact with the top burners (or heating elements), burner grates or other areas near the top burners or oven until they have had sufficient time to cool. These areas can get hot enough to cause burns.

 **WARNING**

NEVER leave cooking food unattended.

Turn pan handles inward, but not over the tops of the other range burners.

Ensure that pans used are large enough to contain the food and avoid boil-overs. Heavy splattering or spills left on the cook top can ignite and cause burns.

 **WARNING**

If using glass, ceramic, earthenware or other glazed utensils (or cookware) verify that it is safe for use on the top burners.

Only certain types of utensils (or cookware) are suitable for surface or top burner use.

Cooking with Propane

For additional safety instructions, See page 111 - 117, Propane System.

Range Hood

The range hood has a both a light and fan control switch on the front panel. The 8" x 8" aluminum mesh grease filter (located on the underside range hood) can be gently hand-washed using mild soap and water.

Range Top with Oven

To prevent damage, ALWAYS use the manufacturer recommended size flat bottom pan(s). Properly matching pan size to burner size will improve efficiency. The pan should be large enough to cover the range top burner, but not more than one inch larger than the burner grate.

- The use of *undersized* pans could expose a portion of the heating element to direct contact and **may result in ignition of clothing.**

DO NOT use large pots & pans, broiler pans, griddles, etc., that cover more than one range top burner at a time. This will create excessive heat that may cause melting, sooting, or discoloration.

In Case Of A Grease Fire

Grease is flammable. Wipe any spills immediately. NEVER allow grease to collect around the top burners or on the cook top surface.

If a fire does start, follow these basic safety rules:

1. Have everyone evacuate the RV immediately.
2. After everyone is clear and accounted for, check the fire to see if you can attempt to put it out. If it is large or the fire is fuel-fed, get clear of the RV and have the Fire Department handle the emergency.
3. Try to smother a flaming pan with a tight-fitting lid or cookie sheet.
4. Never pick up a flaming pan.
5. Flaming grease *outside* of the pan can be extinguished with baking soda or a multipurpose Dry Chemical or Foam-Type fire extinguisher.

Electronics

The following is a basic overview of the audio/visual (A/V) electronics operation. The information in this section is written for original factory-installed equipment usage. Refer to the manufacturer's user guides included in your Owner Information Package for detailed operating instructions for each specific component, or visit that manufacturer's website.

If there have been modifications or replacements made to your RV, then these instructions may not apply. Please contact the service center or technician who performed the modifications or substitutions if assistance is required.

Audio/Visual System Guide

Radio operation:

1. Turn ON the radio.
2. Select speaker output using the controls on the radio face.

CD operation

1. Turn ON the radio.
2. Select speaker output using the controls on the radio face.
3. Insert CD to play.

TV operation

1. Turn on the TV power supply.
2. Turn on the TV and select your signal input using the "source" button.
3. Adjust the TV Antenna/Channel Tuning as needed.
 - See **page 123**, *TV Roof Antenna*.

DVD operation

1. Turn off the TV power supply.
2. Turn ON the radio (the TV speakers are not used).
3. Insert DVD to play.
4. Turn on the TV and select your signal input using the "source" button.
5. Select speaker output using the controls on the radio face (the TV speakers are not used).

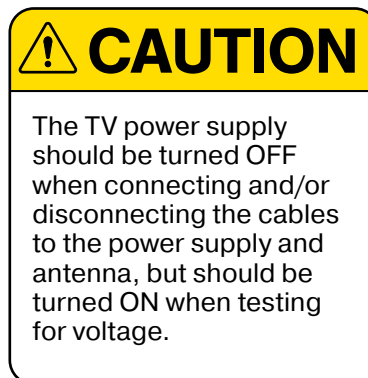

TV Reception Basics

TV broadcasting is a point-to-point communication. Any obstructions between the transmitter and the antenna will degrade the signal, affecting picture quality.

- Television stations transmit their broadcast signal "over the air" to surrounding areas.
- TV antennas are designed to receive the broadcast signals.
- Picture quality depends on the antenna type and your distance from the transmitter.
- The further you are from the transmitter, the weaker the signal becomes, affecting picture quality.

TV Signal Booster

- **The TV Signal Booster must be turned ON for improved *antenna* reception.**
- The TV Signal Booster sends 12-volt DC power to the TV roof antenna. This voltage energizes the transistors in the antenna head amplifier.
- Turn OFF the *TV Signal Booster* to view cable/satellite TV, or to use a DVD/Blu-ray player or Game System.

Cable/Satellite Outlet

Both Cable and Satellite connection outlets are found in the outside utility center.

- The *Cable* input connects to an RG6 cable run through in-line splitters to provide service at multiple locations.
- The *Satellite* inputs connect to RG6 cables run directly to specific locations (no splitters). This allows for clean transfer of HD signals from the satellite dish.

Please refer to the (customer supplied) satellite manufacturer manual for setup, care and maintenance instructions.

TV Roof Antenna

To watch local TV stations, turn ON power to *both the TV and the TV Roof Antenna*. For the best TV reception, your antenna must point toward the nearest signal transmitter. You can find the exact locations of transmitting towers at www.fcc.gov/reports-research/maps/dtv-maps/

Winegard AIR 360 Operation (If So Equipped)

- You must run a *Channel Scan* on your TV in order to receive maximum programming.
- Ensure the antenna power supply (wall plate) is in the “ON” position and the indicator LED is illuminated.
- A new scan will find any new channels that have been added in your area as well as finding any channels that have changed or moved since the last scan.

While the steps to perform a channel scan may vary between televisions or compatible devices, below are some general guidelines to follow.

How to Run a Channel Scan using the TV remote:

1. Select “Menu” *then* select “Settings.”
2. Select “Channel Setup.”
3. Select “Antenna” or “Air,” depending on your TV. Make sure you are not on “Cable.”
4. Select “Channel Search” or “Channel Scan.”
 - The steps to perform a channel scan may vary.
 - If the wording on your TV differs from the options shown, refer to your TV user manual for help.
 - **Running a *Channel Scan* is NOT the same as pressing Channel UP/DOWN on your remote.**
5. To keep your saved channels up-to-date, it is recommended to run a *Channel Scan*:
 - Once per Month
 - When a channel is lost, *and*
 - When you change locations.



Antenna Power Supply
(Wall Plate)



*Back-Up Camera
(Customer Supplied)*



*Back-Up Camera Prep.
Rear Mount Bracket*

Back-Up Camera (Customer Supplied)

Your Momentum M.A.V. TT is pre-wired and prepped for a Furrion® *Vision S* Back-Up Camera (Customer Supplied). When used as an observation system, this product is intended to assist in safe driving and to allow the driver to have a broader view.

- ***Please contact your Grand Design RV Dealer for more information and ordering.***

Heating & Cooling

This following section contains an overview of the original factory-installed heating and cooling components. For more information on each specific component, please refer to the manufacturer's operating instructions found in your Owner Information Package.

If there have been modifications or replacements made to your RV, then these instructions may not apply. Please contact the service center or technician who performed the modifications or substitutions if assistance is required.

Air Conditioner

Your thermostat controls the roof-mounted air conditioning system equipped on your RV. **BEFORE operating the air conditioner: ALWAYS check that you have sufficient power available.**

Cooling vs. heat gain

Under the best conditions, the roof air conditioner(s) can **ONLY** cool the temperature of outside air by 20° F. During hot weather your RV will absorb heat throughout the day, increasing the inside temperature. This is referred to as **heat gain**.

To keep the inside temperature comfortable, reducing the RV's heat gain is just as important as the cooling ability of your air conditioner. **To reduce heat gain, follow these steps:**

1. Park the RV in a shaded area.
2. CLOSE the window shades, blinds or drapes.
3. Use the awnings to shade your RV from sun exposure.
4. AVOID the use of heat producing appliances.
5. SET the air conditioner *Fan/Cooling mode* to HIGH.
 - During high humidity or high temperatures, this will provide maximum efficiency.
6. Turn ON the air conditioner early in the morning, to give it a head start on cooling.

NOTICE

DO NOT operate the air conditioner without the Return Air Filter. Operation without the filter allows lint and dirt normally stopped by the filter to accumulate on the air conditioner's cooling coil. This will lead to a loss of air volume, possible equipment damage and an expensive cleaning process.

! WARNING

DO NOT operate the furnace when the slide rooms are retracted in the closed position.

! WARNING

The furnace should be inspected periodically (*monthly* during the heating season) for the presence of soot on the vent.

Soot is formed whenever combustion is incomplete. This is a visual warning that the furnace is operating in an unsafe manner.

If soot is observed on the vent, IMMEDIATELY shut the furnace OFF and contact a qualified service agency. Operating the furnace under this condition could lead to serious property damage, personal injury or loss of life.

! WARNING

To ensure your personal safety, DO NOT obstruct or alter the furnace in any manner. DO NOT install screens over the vent for any reason. Screens will become restricted and cause unsafe furnace operation. For your safety, only OEM factory authorized parts are to be used on your furnace.

NOTICE

DO NOT leave a roof vent open when the RV is stored or unattended for long periods. High winds, other unusual conditions or obstructions may occur; and if so, the resulting leakage could cause non-warrantable damage.

Air Conditioner, Continued

Air conditioner gasket

The air conditioner is subjected to wind pressures along with motor vibration during normal operation. A *Foam Gasket* forms a weatherproof seal between the roof material and the sub-frame of the air conditioner.

- INSPECT the gasket seal (at least) annually.
- CHECK for leaks and RE-TIGHTEN the mounting bolts if needed.
 - To prevent damage to the gasket - use care; DO NOT *over-tighten* the bolts.

The air conditioner gasket will eventually wear out and need replacement. To gain access to the bolts, remove the filtered panel cover on central air systems or the entire air box on non-central air conditioners.

Furnace

The RV furnace installed in the RV is controlled by a thermostat. The furnace requires both 12-volt power and propane gas for full operation. Make sure you have sufficient power available before operating your furnace.

- ALWAYS have your furnace maintenance completed by a qualified technician (at least once a year, more often depending on furnace use).
- NEVER attempt to repair the furnace yourself.

If you have any questions, Contact your dealer or Grand Design Customer Service.

Roof Vents

The roof vents allow fresh air to circulate through your RV. They may be electric (12-volt DC) and/or manual. Make sure that roof vents are closed while traveling, and when you will be away from the RV, to prevent unexpected weather damage.

Thermostat

BEFORE use, please read and understand the manufacturer instruction manual found in your *Owner Information Package*.

Your Single Zone thermostat is equipped with a liquid crystal display (LCD) to indicate the temperature set-point in Fahrenheit (°F)/Centigrade(°C) and fan speed. It also indicates the available system operation modes.

NOTE: The available operation modes will be different depending on the system installed in your RV.

Operation

Your Furrion wall thermostat has been preprogrammed with factory default settings. Review the settings below and adjust to your comfort level.

Factory Settings	
Heating	68° F / 20° C
Cooling	72° F / 22° C
Fan Speed	Auto
Mode	Cool
Furnace Differential	2° F

To turn ON/OFF: PRESS and HOLD  button for 3 seconds.

NOTE: The LCD will display the last setting if you have changed the parameters

- PRESS the  button repeatedly to toggle through the available modes. *The activated mode icon and temperature set-point will be displayed on the LCD.*
- PRESS the UP arrow to *increase* the temperature set-point.
- PRESS the DOWN arrow to *decrease* the temperature set-point.
- PRESS the FAN button to change the fan speed.
- Simultaneously PRESS both the UP and DOWN arrow buttons for 3 seconds to toggle the temperature format between Centigrade and Fahrenheit.

NOTE: °F indicates Fahrenheit and °C indicates Centigrade



The Digital Thermostat is wall-mounted inside the RV

! WARNING

PINCH HAZARD.

Keep CLEAR of arm assemblies while closing awning. Arm assemblies will fold/close against back channel. Failure to obey this warning could result in death or serious injury.

! CAUTION

This manual provides operational procedures for Solera® Power Awning. Operating the Solera® Power Awning in any other manner than described may result in personal injury, damage to the recreational vehicle or the awning assembly as well as voiding the Lippert Components Limited Warranty.

! CAUTION

During incidents of heavy rain, high wind, or extended time away from the unit, it is advisable to **retract the awning completely** to prevent damage to the awning and the RV.

Fig. 1



Fig. 2



Patio Awning

System Information

The Solera® Power Awning features an internal motor to steadily operate the awning. Additionally, the friction joint allows for rain dump and adjustable pitch features, and there is no rafter arm to lock in place. The friction joint also provides added stability. Locate the Awning switch on the Command Center.

NOTE: Some coaches may not use the LCI switch (Fig. 3).

EXTENDING the Awning

1. Verify the RV battery is fully charged and connected to the electrical system.

NOTE: This latch is optional and may or may not be installed on one or both support arms.

2. Locate the locking latch (Fig. 1), if equipped, and unlock the latch (Fig. 2).
3. Press and hold EXTEND (3A) until the awning is extended completely.

NOTE: Extension is considered complete when the fabric is completely unrolled, the valance seam is visible and a section of the roll tube is exposed (Fig. 4).

NOTE: The awning fabric should always be above the roll tube. However, if the extend switch is engaged too long or extend is hit inadvertently instead of retract, the awning will roll up backward. *This is not a defect.* To correct the fabric orientation, press the RETRACT button. The awning will then extend to its correct orientation and normal operation can resume.

RETRACTING the Awning

1. Verify the coach battery is fully charged and connected to the electrical system.

NOTE: The awning can be retracted without resetting the pitch.

2. Press and hold RETRACT (Fig. 3B) until the awning is retracted completely.
3. Locate the locking latch (Fig. 2), if equipped, and lock the latch (Fig. 1).

NOTE: This latch is optional and may or may not be installed on one or both support arms.

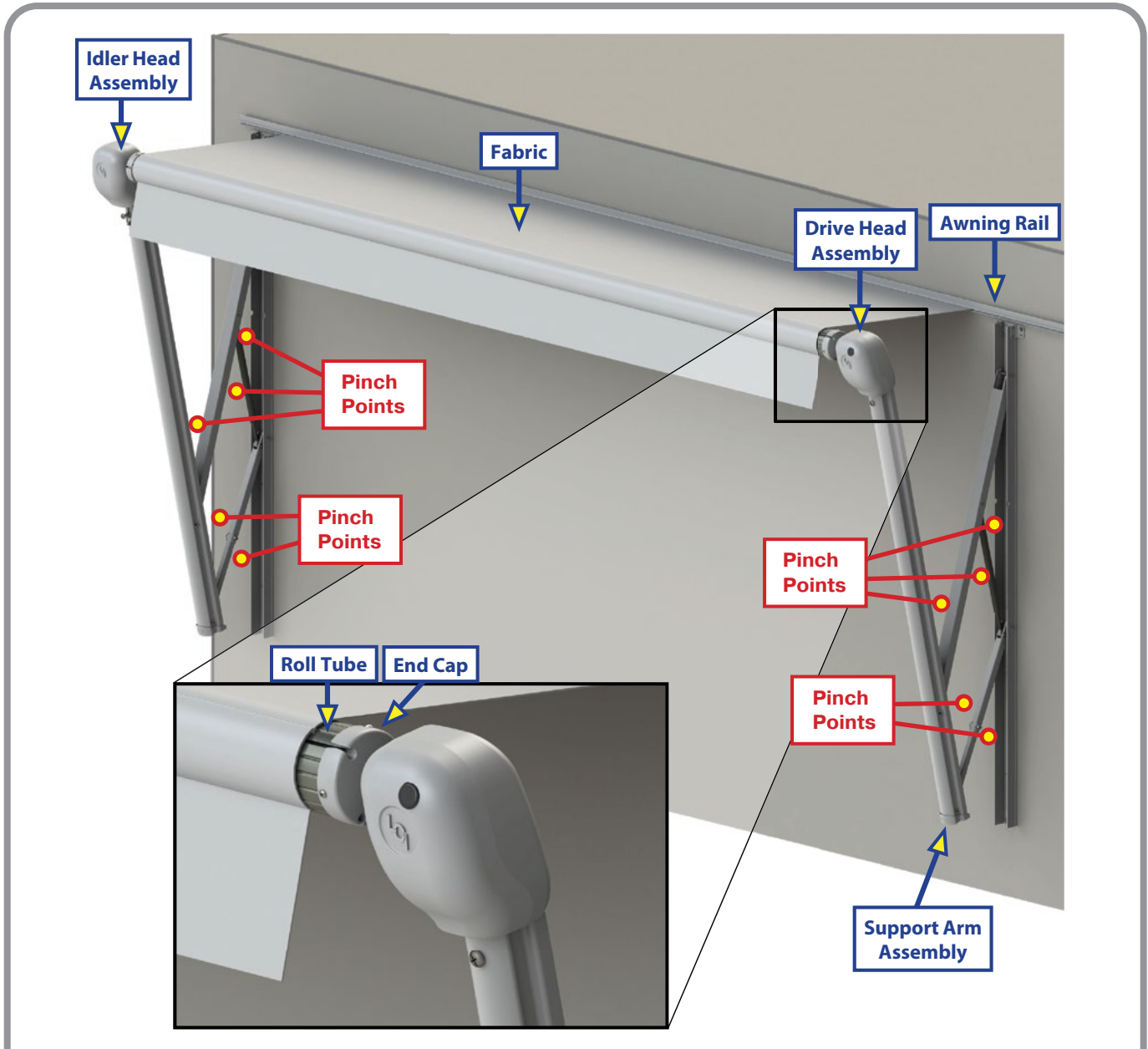
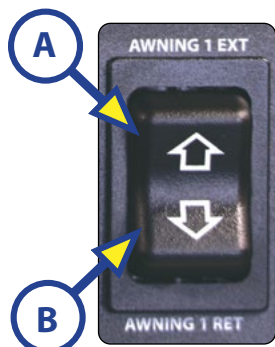
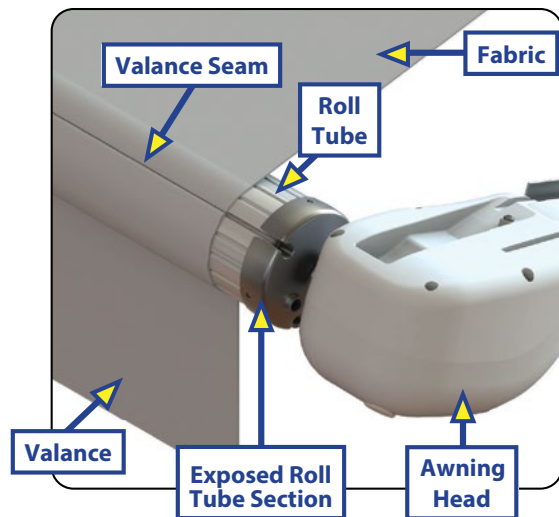

Fig. 3



The Patio Awning Switch is located inside the RV, on the Command Center.

Fig. 4 - Complete Extension



CAUTION

Tying down the roll tube once the awning is extended will not allow the free-floating support arms to work as designed and may cause damage to the awning or RV.

Patio Awning, Continued

Adjusting Pitch - All Solera Awnings

NOTE: The awning will pitch itself to purge the pooling of excess water and may dump a significant amount of water without notice

1. Pitch can be set by adjusting the articulating arm to tip to one side of the awning to allow water runoff.
2. Extend the awning to desired position.
3. Choose the side of the awning for optimum shade or convenient water runoff.
4. Pull downward on the joint of the articulating arm until desired pitch is set (Fig. 5) to allow for water runoff.
 - Do not push the joints of the articulating arms up.
 - This will put tension on the gas strut, which can cause the strut to break.
 - Belleville washers and bolt (Fig. 6A) allow the joint to remain in the position set by the operator.

NOTE: The awning can be retracted without resetting the pitch.

NOTE: If the articulating arm does not hold position, it can be tightened by adjusting the bolt (Fig. 6A) in the center of the articulating arm.

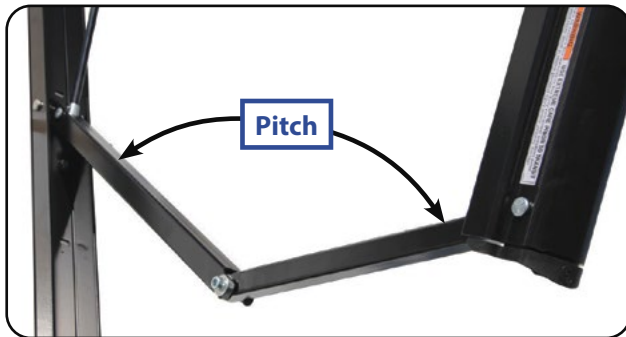

Fig. 5

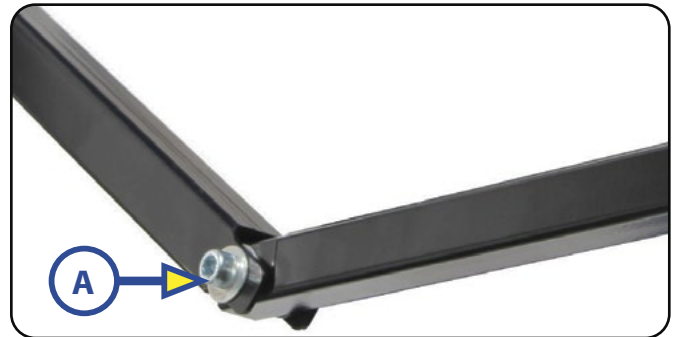

Fig. 6

Maintenance - All Solera Awnings

Fabric Care

If the awning is rolled up while wet, roll it out and let it dry as soon as conditions allow before rolling it up again. This will help prevent the formation of mildew and add greatly to the life of the awning. Mildew does not form on the fabric itself, but on the accumulated dust, dirt and grime.

- Periodically clean vinyl or woven acrylic fabric using a mixture of ¼ cup of dish soap and 5 gallons of warm water.

- Liberally slosh the mixture on the top of the fabric and roll up the awning for 5 minutes.
- This will apply the mixture to the bottom of the fabric as well.
- Roll the awning back out and hose off with fresh water.
- Repeat if necessary. Allow to dry before rolling up.

Troubleshooting

Manual Override

In the event of power loss or motor failure, the awning can be extended and retracted manually. Perform the following procedure to manually retract the awning.

NOTE: This procedure may also be performed to extend or retract the awning in the event of dry camping or camping without a battery.

1. Remove the rubber grommet (Fig. 7A) from the drive head assembly, exposing the manual override nut on the motor.

NOTE: The drive head assembly is always located on the right side of the awning as it is viewed from outside of the coach.

2. Using a $7/16$ " socket and cordless/power drill, spin the manual override nut counterclockwise to retract the awning (Fig. 8).

NOTE: A ratchet may also be used to turn the manual override nut. Using a ratchet will take a significant amount of time and should only be used if no cordless/power drill is available.

NOTE: Use caution when retracting the awning manually. The use of a step stool or ladder may be required to completely retract the awning.

3. When the awning is completely retracted, remove socket or drive device and replace the rubber grommet in the drive head assembly.

NOTE: The motor's internal drive system prevents the awning from moving (extend or retract) on its own.

For more information, please refer to the awning manufacturer's user manual.

WARNING

DO NOT attempt any repairs to any awning. The awning roll tube is under extreme spring tension. Repairs should only be performed by an authorized dealer and/or repair center.

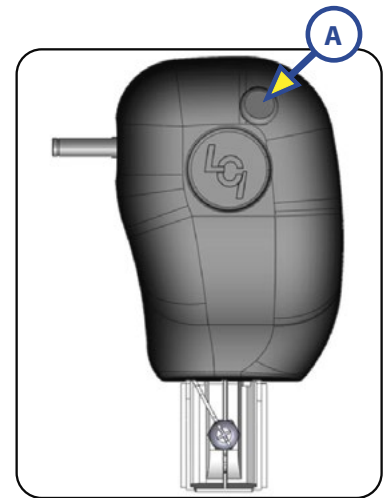

Fig. 7



Fig. 8

 **WARNING**

The slideout room and mechanism are a potential crush hazard. Disconnect the auxiliary battery to disable power to the slideout(s) before working on or under them. Failure to do so could result in serious injury or death.

 **WARNING**

Stand clear of the room's interior path and verify there are no exterior obstructions before extending or retracting the slide-out. Failure to do so could result in serious injury or death.

 **WARNING**

The slideout mechanism has hard, sharp metal edges. DO NOT allow children to play under a slideout in the extended position. Failure to do so could result in serious injury or death.

 **WARNING**

Ensure the slideout is in the closed position prior to hooking the RV to the tow vehicle. Failure to do so could result in serious injury or death.

Slideout Systems

Slideout rooms are designed to provide you additional living space during stationary camping.

BEFORE operating your slideout system:

- Check that you have sufficient power available.
 - LEVEL *and* STABILIZE the RV
-
- Leveling helps to keep the RV square, so the slideouts extend, retract and seal correctly.
 - If the RV is NOT level, the slideout rooms and/or mechanisms may become damaged.
 - The slideout rooms DO NOT need additional support. Non-warranty damage can occur from improper use of aftermarket support jacks.

Slideout Operation

It is normal for the slide rooms to make *creaking* or *squeaking* noises while moving. These noises are especially common during the break-in period while the components are seating properly. This will decrease after a few extend/retract cycles. Note that there will always be some noticeable noises when operating the slideout.

1. **ALWAYS level and stabilize the RV, BEFORE operating your slideout system.**
2. Check that your auxiliary battery is fully charged or the RV is connected to shore power. Turn off all unnecessary lights to maximize available power.
3. Close all cabinet doors and drawers.
4. BEFORE extending or retracting:
 - Check that the *interior* path of the slideout room is clear of people, pets, furniture, clothing, etc.
 - Check that the *exterior* path of the slideout room is free from any obstructions.

5. Inspect the sides, top and bottom of the extended slideout room. If the outside of the slideout room is wet, wipe it dry before retracting.
6. Clean any water puddles or debris brought inside your RV from slideout operation immediately.
7. Press and hold the appropriate slide room switch to either IN or OUT, until the room is completely extended or retracted.

- DO NOT hold the slide room switch past the point the room is fully extended/retracted or damage may occur.
- For the weather seals to be effective, the slideout room MUST be *completely* extended/retracted.
- BEFORE operating your slide system, review all important safety alerts.

Slideout maintenance

While the slideout room is *extended*, the outside surfaces of the room and mechanism may collect dirt and debris. The slideout seals are not designed to remove the debris or any water that may accumulate.

- When you **retract** the slideout, any debris on the *outside* of the room, is brought *inside* your RV.

BEFORE retracting the slideout(s):

- Inspect the outside surfaces for snow, ice, dirt, dust, insect nests, etc.
- Check for standing water on the slideout topper awning (if so equipped).
- Clean and dry the outside surfaces of the room and mechanism as much as possible.

Contact your dealer or Grand Design RV Customer Service for troubleshooting and/or repair *if your slideout system:*

- Stalls out before reaching end of stroke, *or*
- Does NOT close and seal tightly.



The Slide Room Switches are located inside the RV, on the Command Center.

NOTICE

Inspect both sides of the slideout room for interior or exterior obstructions prior to operating.

NOTICE

Ensure that the RV is level before operating the slideout room.

Water leaks and other problems could result if the slideout is operated without leveling the RV.

NOTICE

For long-term storage, it is recommended that the slide rooms be closed (retracted).

NOTICE

Never 'jump' or charge the auxiliary battery from the power connections on the InWall Controller. Always do this at the auxiliary battery.

CAUTION

Always disconnect battery from the system prior to manually operating system. Failure to disconnect battery can cause electricity to back feed through the motor and cause serious damage to the system as well as void the warranty.

NOTICE

Use EXTREME CAUTION if using the manual override feature to extend and/or retract the room.

It is possible to extend or retract the slideout beyond the maximum open or closed positions. This can result in damage to the slide components, slide room structure or trim components.

Lippert Through Frame Electric Slideout System

Extending and retracting the slideout room is powered by the Lippert Through Frame Electric Slideout System. It is a rack and pinion guide system with a motor driven ball screw actuator. The actuator is equipped with an automatic clutching system. The Lippert Electric Slideout System is designed to operate as a negative ground system.

Manual operation

The Lippert Through Frame Electric Slideout System comes with a manual override. Locate the 1" round Slideout Override Access Hole in the skirt metal on the opposite side (of the RV) from the room that you are trying to move.

- **Disconnect your RV battery.**
- Insert the crank handle extension.
- Turn **clockwise** to retract the slideout room.
- Turn **counter-clockwise** to extend the slideout room.

If using the manual override feature :

Use EXTREME CAUTION to extend and/or retract the room. It is possible to extend or retract the slideout beyond the *maximum* OPEN or CLOSED positions.

This can result in damage to the slide components, slide room structure, or trim components.

IMPORTANT: The actuator is *manual ready*.

- DO NOT disengage the motor.
- Just hook up and crank.



Slideout Override Access Hole & Crank Handle Extension

Maintenance

Although the system is designed to be almost maintenance free, actuate the room once or twice a month to keep the seals and internal moving parts lubricated. Check for any visible signs or external damage before and after movement of the RV.

- For the best performance, the slideout system requires the auxiliary battery be fully charged.
- Check for corrosion, and loose or damaged terminals/connections at the battery, the control switch, and the electronic actuator motor.
- Check that the motor leads under the RV chassis are in good condition. These connections are subject to damage from road debris.
- When operating the Lippert electric slideout system in harsh environments (i.e., road salt, ice buildup, etc.) keep all moving parts clean, washing them as needed, with mild soap and water.
- Grease or lubrication is NOT necessary. It could even harm the long-term dependability of the slideout system.

Service and adjustments

- Slideout room adjustments should be performed ANNUALLY by a certified RV service technician.
- Any adjustments made by non-certified persons may void any and all warranty claims.

DANGER

Vehicles and equipment powered by internal combustion engines and placed in RVs may cause carbon monoxide poisoning or asphyxiation, which could result in death or serious injury.

The flammable liquids used to power these items can cause a fire or explosion, which can result in death or serious injury.

To reduce risk:

1. DO NOT start & idle the vehicle in the storage area.
2. DO NOT sleep in the vehicle storage area when vehicles are present.
3. Close doors separating the living area and garage when any vehicle is present.
4. DO NOT store, transport or dispense fuel inside of the RV.
5. Open the air ventilation systems provided for venting while transporting vehicles.
6. DO NOT operate propane appliances, pilot lights or electrical equipment when motorized vehicles are present.

Garage

Ramp Door

- Please use **CAUTION** at all times the rear loading ramp/door area of your RV is in use.

The *Rear Ramp Door* is easily operated by one person to give full access to the garage. UNLOCK & UNLATCH by lifting and turning the handles on each side of rear door. *See photos below.*



- ALWAYS check that the area behind the RV is clear before unlocking and lowering the ramp door.
- When lowered, the ramp allows you to easily load small vehicles, motorcycles, bicycles, and rolling cargo.
- Use the *Tie Down Points* located in the garage floor to secure all vehicles or cargo items so they cannot come loose, unfastened, opened or released while the RV is in motion.

Retractable Screen Wall (If So Equipped)

To avoid possible injury and/or damage to the Screen Wall, ALWAYS **fully EXTEND** and **fasten** the floor snaps when in use, and **fully RETRACT** when NOT in use.

- CHECK that all obstacles are removed from the path of the *screen wall*.
- LOCATE the *strap* attached to the *screen wall pull bar*.
- PULL DOWN first by the strap, *then* by the pull bar until the screen wall is completely extended.

To store the Screen Wall:

- PULL UP on the pull bar handle to release it from the grabber catch, then PUSH UP the screen wall until it is fully retracted.

Patio Deck (If So Equipped)

Your unit may be equipped with a patio deck complete with folding rails. Caution should be taken not to exceed the ramp door weight capacities when in either the ramp position or the patio deck position, and to maintain even weight distribution.

See *Patio Rail Kit*, starting on the **next page**.

ALWAYS follow all instructions and safety labels while using your M.A.V. TT's Ramp Door / Patio Deck.

WARNING

Maximum Capacity is based on an evenly distributed load in the patio position.

- Failure to observe the weight limit or use other than intended may result in personal injury.

CAUTION

When returning the ramp door to the stowed position, be sure all safety pins used to secure the rails during transit are in place and secured in place with the safety clip.

Failure to do so could result in damage to the rail and ramp door.

WARNING

Secure vehicles and cargo as far *forward* as possible.

- Excess weight in the rear of this RV can result in loss of stability.
- Consult the RV owner's manual for loading and weighing procedures.
- **DO NOT** exceed the RV's GVWR (total weight rating) or GAWR (axle weight rating). Move vehicles and/or cargo to maintain proper balance.

WARNING

- Patio has a Maximum Capacity of 10 persons or 1,500 lbs maximum. The total weight of the patio **MUST** remain within the 1,500 lb. limit.
- Stabilizer jacks **MUST** be used when the ramp door is in the patio position.
- Support jacks on the patio door must be used where applicable.
- Exceeding load limit may lead to collapse and possible personal injury.

CAUTION

- Maximum Capacity is 3,000 lbs in the ramp position with the load evenly distributed.
- Maximum 1,000 lbs per wheel contact.
- Exceeding load limit may lead to collapse and possible personal injury.

WARNING

- Failure to follow these instructions may result in death, serious injury or property damage.
- **ALWAYS** secure the ramp door in either the closed, ramp or party deck position.
- **NEVER** use the ramp door while anything is obstructing operation.
- Keep hands away from all openings, rollers and cables when operating the ramp door.

CAUTION

- Failure to follow these instructions may result in serious injury or property damage.
- Read the instructions before installation or operation.
- **NEVER** force the ramp door in any direction.
- **ALWAYS** make sure the cables are pulling out straight, staying in the grooved portion of the rollers and not coming in contact with any obstruction.
- **DO NOT** operate the ramp door if the cable is frayed or damaged.

Patio Rail Kit

LIPPERT PATIO RAIL KIT 3000 SERIES ASSEMBLY

DOORS

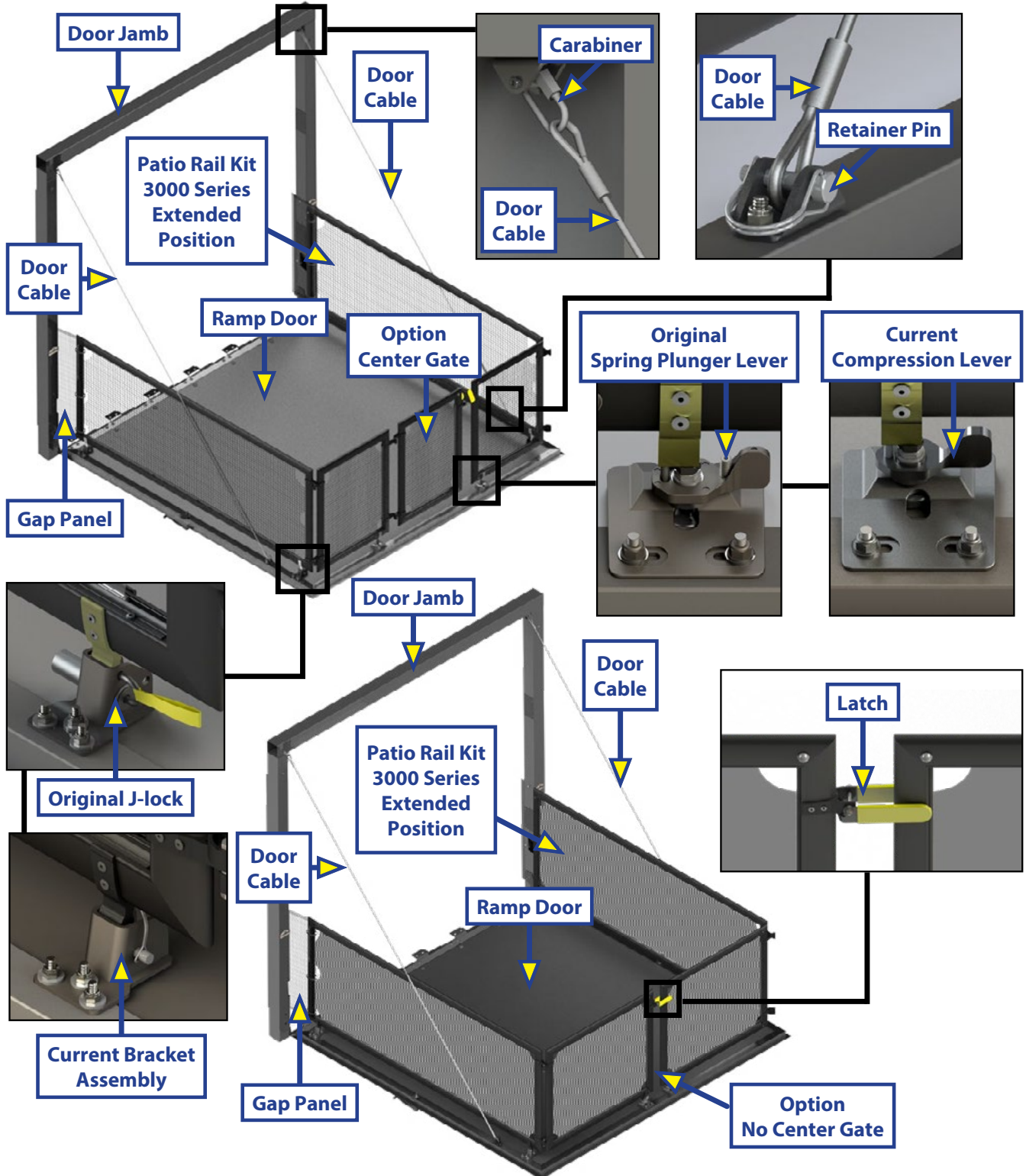

LIPPERT PATIO RAIL KIT 3000 SERIES ASSEMBLY

DOORS

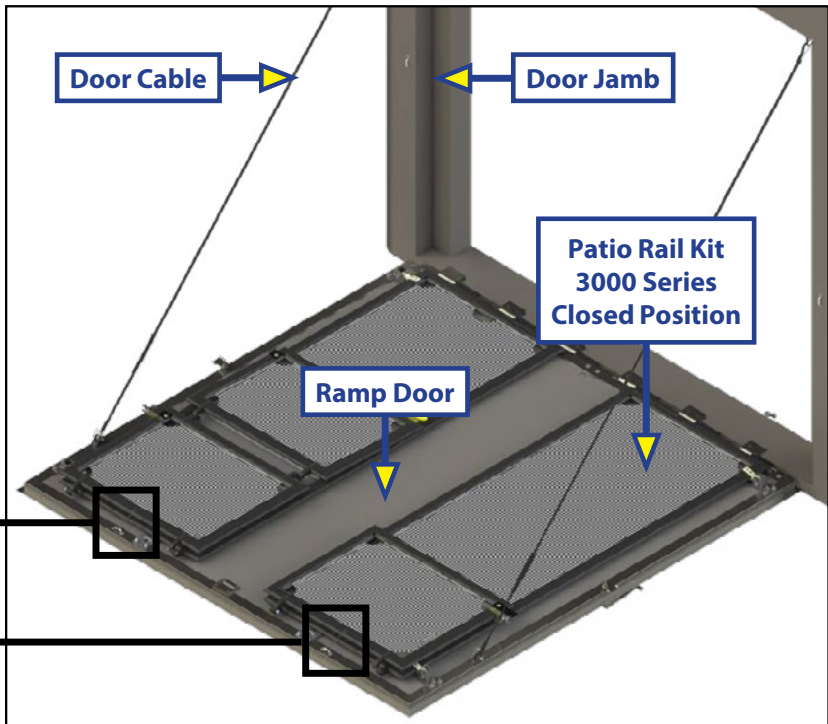
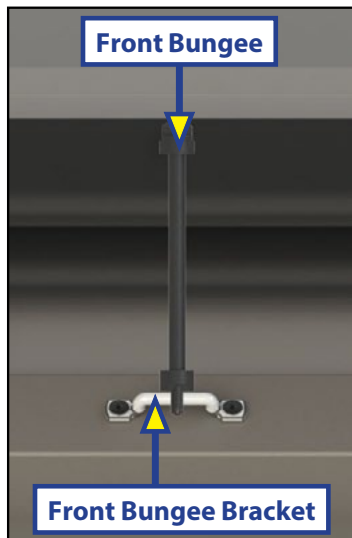

NOTE: Center gate option will have 3 snaps. No center gate option will have 2 snaps, one on each side of the patio rail kit.

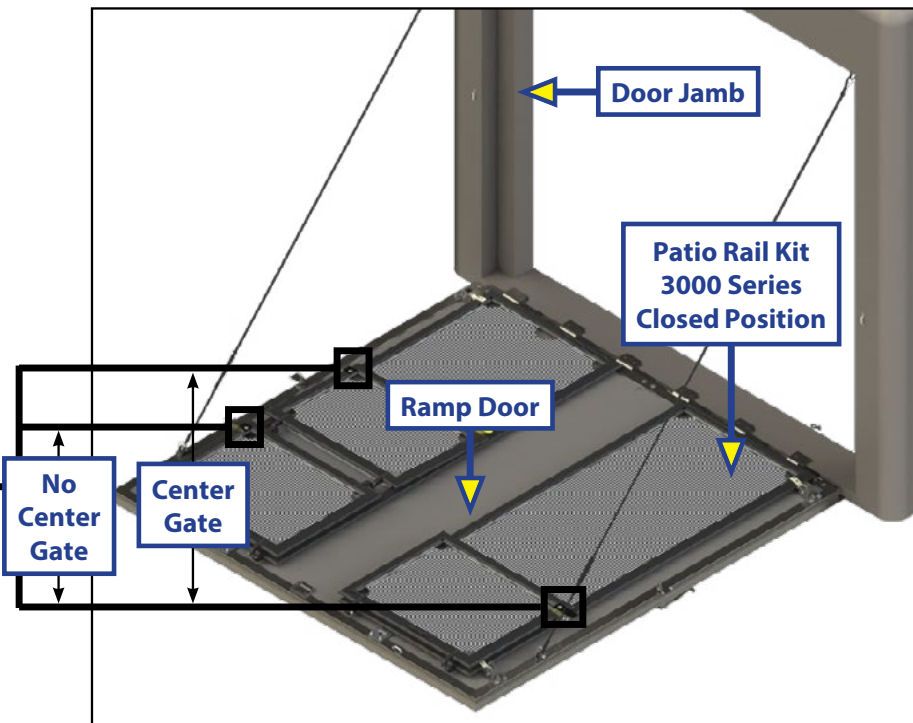
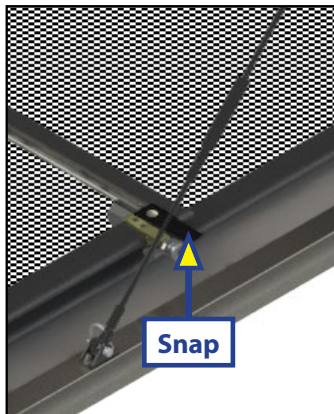

LIPPERT PATIO RAIL KIT 3000 SERIES ASSEMBLY

DOORS

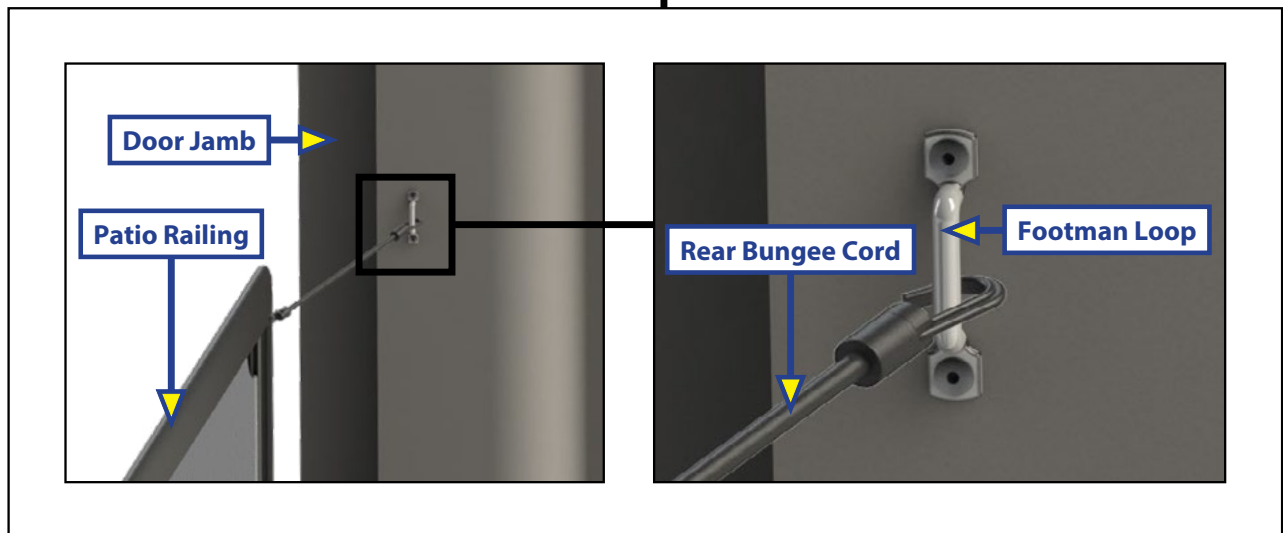
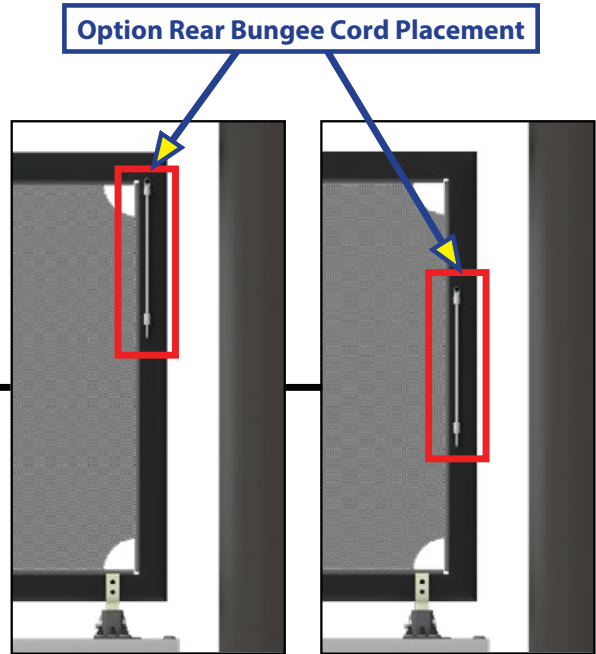
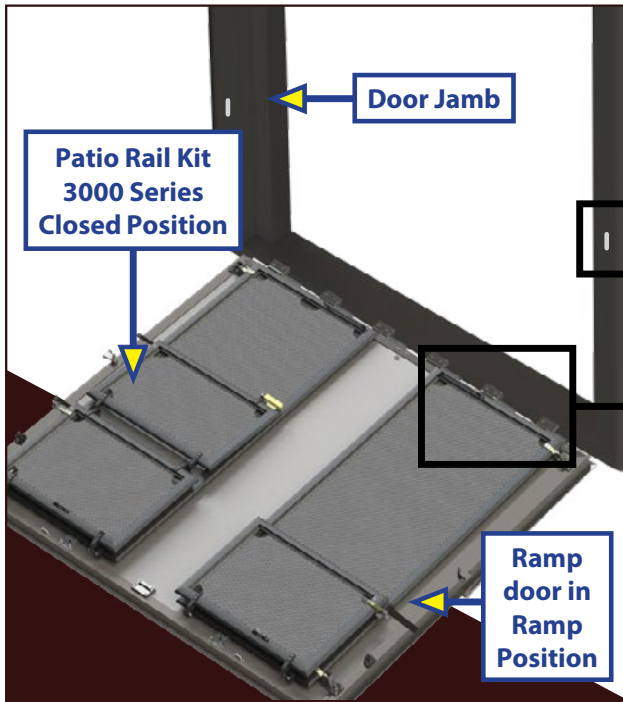

Interior Care

Cleaning the Interior

To keep the value of your RV, perform regular maintenance using the proper materials and procedures.

- Check the component manufacturer's information for the recommended cleaning agent.

Using the wrong cleaner may result in damage to the surfaces in your RV. To check if a cleaner will cause damage, test it in a small, out of sight area, or contact your dealer for assistance.

DO NOT use flammable liquids or sprays to clean your RV.

Cabinetry & Tables

- To keep cabinetry and tables looking like new, regularly dust the hardwood doors, cabinet fronts and tables.
- Use a soft cloth dampened with a cleaning polish or mild detergent solution.
- AVOID using ammonia based products or silicone oils as they may cause damage if used over a long period of time.
- Although the finish is durable and resistant to most household spills, they should be wiped up promptly to avoid any potential problems.
- Avoid prolonged exposure to direct sunlight, high temperatures or high humidity. These conditions can cause damage to both the finish and the wood itself.

Pantry

Your RV's **load capacity** is designed by *weight*, NOT *volume*. All available storage space cannot necessarily be used.

- Use the pantry to store items you wish to take with you as you travel and camp.
- The cabinetry has been designed to accommodate normal camping items which are bulky but not necessarily heavy (i.e., paper plates, flatware, cookware, etc.).
- Make sure that all pantry items are secured so that they will not shift during travel.

Paneling

- To clean, use a mild solution of soap and lukewarm water with a soft sponge or cloth.
- DO NOT use abrasive cleaners as they could cause the vinyl to scratch and turn dull.
- Grease spots and stubborn dirt can be cleaned off with an all-purpose spray

Countertops

To prevent permanent damage:

- ALWAYS use hot pads or trivets under hot pans, dishes, or heat producing appliances such as frying pans.
- ALWAYS use a cutting board; never use a knife directly on the countertop.
- AVOID harsh chemicals such as drain cleaners, oven cleaners, etc.
- DO NOT leave cleaners with bleach on the surface. Wipe them off promptly.

Laminate countertops

Glass rings, food spills, water spots and smudges usually wipe off with a damp sponge. Stubborn stains can be removed with a general-purpose spray cleaner. Some stains can be removed by squeezing fresh lemon juice over the stain and allowing the juice to soak for approximately forty-five minutes. After 45 minutes, sprinkle baking soda over the lemon juice and rub with a soft cloth.

Solid surface countertops

Solid surface materials are easy to clean. Commercial solid surface cleaners, soapy water, or ammonia based cleaners will remove most dirt and residue from all types of finishes. AVOID window cleaners as they can leave a waxy build up that may dull the surface. A damp cloth followed by a dry towel will remove watermarks. Disinfect the surface periodically with diluted household bleach (one part **water** to one part **bleach**).

For additional information on the removal of difficult stains or surface damage repair, please refer to the countertop manufacturer's user guide.

Flooring

- ALWAYS test cleaning agents for colorfastness in a hidden or inconspicuous area.

Carpet

Vacuum regularly with a vacuum cleaner with a revolving brush or beater bar. Be sure the vacuum does not have teeth, combs or rough edges as they may damage the carpet. It is important to remove loose soil and debris while it is on the surface. Heavily traveled areas (i.e., walkways, areas in front of the furniture) may be protected with small throw rugs to prolong the life of the carpet.

Some spills contain chemicals that will destroy carpet fibers and dyes. If you have doubts about what caused the spot, contact a professional carpet cleaner. Because of the additional dirt typically associated with camping, we recommend that you vacuum the carpet frequently. Have tough and deep stains professionally steam cleaned. Use spot removers for minor spills. Always test the carpet for color fastness in an inconspicuous area before using any product.

Vinyl flooring

Periodically vacuum or sweep to remove dirt and gritty particles. Although most common spills will not permanently stain the vinyl floors, they are usually easier to remove if wiped up before they set. Simply blot with a paper towel and wipe clean with a damp cloth. As part of a regular maintenance program, sponge mop the entire floor. Do not use dish detergents or vinegar and water because they will dull your floor.

To care for the vinyl floor covering, use a damp mop with water and a mild cleaner. DO NOT SOAK THE FLOORING. Use care to avoid wetting the carpet edges. To prevent the linoleum from *yellowing*, avoid cleaners that contain oil based solvents (i.e. any cleaners containing lemon oil, Murphy's Oil Soap, etc.).

Free-Standing Table & Chairs

The free-standing dinette table can be positioned to seat up to four people. To prevent damage when traveling, the chairs must be fastened down securely, and the table must be closed into the travel position.

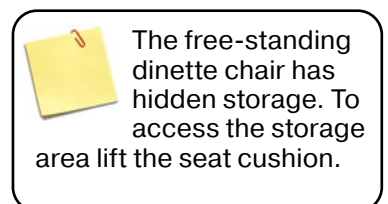

Furniture Upholstery

To retain the value of your RV, maintain the furniture upholstery carefully and keep the interior clean. Vacuum the furniture regularly using a soft brush attachment to remove any loose dirt or debris.

- **Fabric** should be professionally cleaned if it becomes stained or more information, refer to the specific furniture manufacturer's care instructions.
- **Suede** should be professionally cleaned if it becomes stained or soiled.
- **Vinyl** should be professionally cleaned if it becomes stained or soiled. If a spill does occur:
 - Use *water-based* cleaners **ONLY**.
 - **BLOT** up the spot. **DO NOT** rub it in, or saturate the area.
 - **DO NOT use solvents.**
Solvents may have an adverse reaction to the specific backing of your upholstery fabric.
 - **DO NOT dry clean any vinyl components.**
If they are dry cleaned, the vinyl on the reverse side will shrink, become hard and crack.

Clean the **suede** or **vinyl** upholstery **ONLY** as recommended.

- *Any cleaning methods other than those listed, may produce undesired results and even damage the upholstery. This type of damage is not warrantable.*

ABS Plastic

DO NOT use gritty or abrasive particle soaps or scouring compound to clean ABS plastic. ABS plastic components will retain their original beauty with reasonable care. **DUST & WIPE CLEAN** with soft, damp cloth or chamois, wiping gently.

- **AVOID** using *Citrus* or *biodegradable* cleaners containing D-Limonene; these cleaners may damage plastic materials.

Decor Items

Decor Glass

Use a glass cleaner to remove smudges, smears and spots. If there is any decorative etching on the decor glass, use care when cleaning around that area.

Window treatments, curtains, blinds and shades

Dust occasionally with a vacuum and soft brush attachment. Professionally clean only.

Shower Walls & Base

Use a mild detergent soap and warm water to clean the shower wall and base. DO NOT use gritty or abrasive particle soaps or scouring compounds.

Sink & Shower Fixtures

Use mild dish soap and water to clean these fixtures. DO NOT use harsh chemicals or sprays. A mild solution of vinegar and water works well to remove hard water spots and stains from the sink or shower fixture.

Stainless Steel Sink & Appliances

- DO NOT use abrasive cleaners, scouring pads or steel wool.
 - DO NOT use oven cleaner or any cleaners containing bleach or chloride.
 - Hard water that evaporates on a Stainless Steel surface can leave spots.
1. Dampen a soft cloth in warm water mixed with a mild dish soap.
 2. Wipe the surface. Clean *with the grain*, not across.
 3. Rinse the cloth and wipe again.
 4. Blot the surface dry with a towel to prevent water spots.

Glass cleaner or a cleaners made specifically for stainless steel may also be used. BEFORE cleaning the entire surface, test the cleaner on a small hidden area.

Exterior Care

The aluminum exterior has a baked-on, painted finish designed to last for many years. Periodic maintenance is necessary to keep the appearance looking good.

- The chance of damage to the exterior finish increases the longer a foreign substance remains on the surface.
- Frequent washing and waxing is the best way to protect your RV from this damage.

The following materials deposited on the RV's surface may result in corrosion, staining, and/or chemical spotting:

- Road Tar, Dirt, and Dust
- Road Salt and Sodium Chloride
- Bird Droppings / Bugs / Tree Sap
- Acid Rain / Industrial Fallout / Pollution
- UV Exposure and Moisture

Cleaning the Exterior

Frequent washing also protects your RV from environmental conditions, such as rain, snow and salt air.

- Wash your RV as soon as possible if it becomes contaminated with foreign material.
- Avoid parking under trees or near ocean sea salt.
- DO NOT *scrape* ice or snow from the painted surface, ALWAYS *brush off* the affected area.
- If anti-freeze, gasoline or any solvents are spilled on the painted surface, rinse the area with water immediately.
- Bugs and bird droppings should be rinsed off daily.

**AVOID forcing water inside the RV.
This could damage component parts.**

- EXTREME CAUTION should be used with any type of pressure sprayer around all attachments, doors, windows, appliance vents, etc.
- DO NOT take your RV through automatic car washes.
- Keep the washing nozzle about 16 inches (40 cm) or more away from the RV body.
- When washing around the door, vent and glass areas, hold the nozzle at right angles to the surface.

Dirt and Similar Surface Contaminants

The paint surface is formulated to resist most mild cleaners and fresh water. Frequent washing will help avoid staining from debris and soil build up.

- ALWAYS rinse the RV with clear water to remove loose dirt prior to washing.
- Mix a solution of one (1) cup laundry detergent (with less than 0.5% phosphate) per five (5) gallons of water.
- Use a sponge, soft cloth, or soft bristle brush. Clean RV from the top, working your way down, one area at a time then immediately rinse with fresh water.
- Take care not to scratch the painted surface.

Chalking

All paints exposed to direct sunlight will slowly degrade over time losing gloss and leaving a powdery *Chalk*. Rain and weather will normally clean up these loose particles, or they can be removed with a mild soapy wash.

See previous section.

Things to Avoid

- Avoid damaging the original paint surface.
- Avoid acid based cleaners or detergents containing a high percentage of phosphate that may damage the finish.
- Avoid strong commercial cleaners. They should be tested in a small area to determine if they cause any adverse affects.
- Avoid high-pressure washers, rotating brushes (such as in car washes) and power buffers. Use of these products can damage paint finishes and/ or graphics.
 - Avoid use of a pressure sprayer around all attachments, doors, windows, appliance vents, etc.
 - **Stop immediately if the paint is peeling or scratched.**
- DO NOT take your RV through automatic car washes.
- DO NOT use stiff bristle brushes, wire brushes, or abrasive cleansers.

NOTICE

DO NOT use a buffer and a buffing compound as it may damage the exterior surface. Please contact a professional paint body shop for assistance.

NOTICE

DO NOT use waxes containing high-abrasive compounds. Such waxes remove rust and stains effectively, but they are also harmful to the luster of the surface, since they may scrape off the coating. Further, they are detrimental to glossy surfaces, such as the grille, garnish, moldings, etc.

DO NOT use gasoline or paint thinners to remove road tar or other contamination to the painted surface.

Cleaning the Exterior Continued

Mold or Mildew

In warm humid climates, mold and mildew can grow on the exterior. If left on for extended periods, these spores will penetrate the coating reducing its life.

- Mix a solution of one (1) cup mild liquid hand soap, one (1) gallon of bleach and five (5) gallons of water.
- Wash the surface with a sponge and rinse with fresh water. For stubborn stains, use a soft bristle brush.
- Take care with this solution to protect yourself (eyes, skin etc.) and surrounding areas that may be bleach sensitive; ie., plants, carpet, cloth, etc.

Grease, Oil, Wax, Etc.

- Cleaning with the recommended detergent and water solution should be tried first.
- Small areas can be cleaned with an all-purpose spray cleanser.
- Large areas may require a commercial degreaser mixed in a solution of water.

A less desirable alternative is to wipe with a solvent like Xylene or Naphtha. Be aware solvent wiping can affect the long term durability of the paint finish.

- Use plenty of clean cloths to avoid recontaminating the surface or just moving the grease around.
- Observe all precautions for personal safety and fire hazards.

Chrome parts

To prevent chrome parts from spotting or corroding, wash with water, dry thoroughly, and apply a non-abrasive automotive wax. If the chrome is severely damaged or pitted, use a commercially available chrome polish product.

Cleaning plastic parts

Use a sponge or chamois to clean plastic parts. Use warm water and a soft cloth or chamois to remove any white residue from dark colored plastic surfaces. Do not use a scrubbing brush or other hard tools as they may damage the plastic surface. Do not use wax containing abrasives that may damage the plastic surface.

NOTICE

DO NOT allow plastic to come into contact with brake fluid, engine oil, grease, paint thinner, or battery acid. These will damage plastic.

Use a soft cloth and a mild detergent solution to wipe away any such contact.

Damaged paint

Touch up small cracks and scratches in the paint coat of the TT as soon as possible with touch-up film or paint. Carefully check the body areas facing the road and the tires for damage to the paint coat caused by flying stones, etc. To purchase touch-up paint, use the closest automotive paint match available locally. *See Trailer Frame, below.*

During cold weather

IF the slideout or door is frozen shut, opening it by FORCE may tear off or crack its rubber gasket and *ruin* the weatherproof seal.

1. *Instead*, pour warm water on the gasket to melt the ice.
2. *Then*, AFTER opening the slideout or door, wipe off the water thoroughly.
3. To prevent the weather stripping from freezing, treat it with a silicone spray.
4. **Salt and other chemicals spread on winter roads can have a detrimental effect on the RV's underbody.**

If your RV is exposed to these conditions:

- Wash the exterior of your RV and carefully spray the underbody with a high-pressure hose, remove any mud or debris that could trap and hold salt or moisture.
- After washing your RV, wipe off all water drops from the rubber parts around the slideout and doors.

Trailer Frame

Rocks, sand, road debris, climate (salt air exposure) and especially ice inhibiting chemicals used during the winter months will damage your frame's painted exterior, inviting rust and other deterioration.

- Regularly inspect all exposed areas of the frame.
- To maintain protection, **clean** and **repaint** any chipped areas or rust spots.

 **WARNING**

As with the surface of any roof, a rubber roof can be very slippery, especially when wet. If you go up on your roof we recommend extreme caution and suggest that you navigate the roof on your hands and feet. This distributes the weight more evenly and helps reduce the possibility of falling.

NOTICE

Failure to properly maintain or re-seal your RV may result in serious water damage to the roof and other parts of the RV.

This damage is not covered by the Limited Base Warranty and the Limited Structural Warranty.

NOTICE

DO NOT use petroleum distillates to clean the roof as they may cause permanent damage.

Windows

Any ventilating window may permit water inside, especially during heavy rainstorms. Condensation will also cause water to accumulate on windows and in the tracks. Normally the window glass can be cleaned with a sponge and water.

- Use *glass cleaner* to remove wax, oil, grease, dead insects, etc.
- After washing the glass, wipe it dry with a clean, soft cloth.

Exterior Roof

PLEASE NOTE: ONLY THE CORRECT, RECOMMENDED ALPHA SYSTEMS SEALANTS SHOULD COME IN CONTACT WITH YOUR ALPHA ROOF MEMBRANE. (See below)

With the AlphaPly Roof Membrane use:

- **5160 Alphathane Non-Sag Adhesive/Sealant, and**
- **5121 Alphathane Self Leveling Adhesive/Sealant.**

To maintain your warranty, inspect all roof sealant every three (3) months for voids, gaps and cracks *then* re-seal as needed. **Wash the roof membrane with water and a mild detergent twice a year and clean and inspect the roof vents.**

- **DO NOT use sharp tools (putty knife) that could puncture the roof membrane.**
- If any voids or cracking are found, remove any loose sealant *by hand*.
- If the loose sealant cannot be pulled off by hand, it still has good adhesion to the roof membrane and should be left alone.
- Using a medium-bristled scrub brush, clean all areas to be resealed with a non-abrasive household cleaner, such as Top Job® or Spic-N-Span®.
- This area must be dry before continuing.
- **Solvents should NOT be used during cleaning.** Solvents can damage existing sealant and may weaken plastic roof components.
- Apply a generous amount of the **correct Alpha Systems Non-Sag Sealant** over the top of any existing sealant needing to be resealed.

Sidewall Vents

Water heater, furnace and refrigerator exterior doors need to be kept clean and free of obstructions while the appliances (if so equipped) are in use. Inspect the refrigerator and holding tank vents for blockages from bird or insect nests, spiderwebs, leaves, etc.

Sealants

Sealants perform a very important function and should be inspected closely and regularly maintained. We incorporate many different types of sealants, including butyl/putty, black butyl-encapsulated foam, silicone (clear and colored), roof sealant and foam. In general, sealants do not have a "set" lifetime. Varying environmental factors affect the pliability and adhesiveness of sealants.

Sealants may become damaged due to exposure to the elements, freezing temperatures, ultraviolet, and air pollution. If deteriorated, repair immediately to prevent damage. A quick walk around the RV before leaving may help prevent potential problems during trips and vacations. Your dealer service or parts manager can help you obtain the correct sealant(s).

You or your dealer MUST:

- INSPECT all sealants, every three (3) months. Make sure to check the roof and all four sides of the RV including all moldings, doors, vents and exterior attachments.
- REPLACE the sealant if you notice any cracks, peeling, voids, gaps, breaks, looseness or any sign of physical deterioration.
- RESEAL at least one time each year as preventative maintenance. Always use the same type of sealant that was removed.

If you notice water inside the RV, immediately have the dealer check for the source of the leak. Failure to correct the leak may result in serious damage to your RV; this damage may not be warrantable.

If you have questions and/or need assistance with sealing your RV, consult with your RV dealer.

NOTICE

DO NOT add items to the RV rear bumper. Add-on items will eventually damage your bumper. Damage caused by such aftermarket equipment installation or improper loading voids the Limited Base Warranty & Limited Structural Warranty.

WARNING

If your RV is equipped with a roof ladder:

- DO NOT exceed the weight limit of 300 lbs.
- DO NOT leave items attached to ladder while traveling.



Roof Ladder Locking Pins

Rear Bumper

- **The rear bumper of your RV is NOT designed to carry cargo.**
- Extra weight behind the trailer's axles may *reduce* the **Hitch Weight** (leading to adverse handling conditions from wind gusts and passing traffic).
- Items that extend beyond the bumper will place undo strain on the bumper.
- Over time, weight added to the bumper will cause damage from the motion created while traveling.

Roof Ladder (If So Equipped)

Your RV may be equipped with an optional roof ladder. The RV roof has decking under the rubber roof membrane to allow you to walk on the roof (with caution) to do maintenance.

- **ALWAYS check that both locking pins are in place when the ladder is in the stowed (travel) position.**

Winterizing / RV Storage Preparation

To help prevent problems, prepare your RV for extended periods of non-use. This will also make it easier to get your RV ready for the next camping trip or season.

- **In colder climates, BEFORE storing for the winter, be sure your RV's plumbing system is properly *Winterized* to prevent costly freeze-ups.**
1. CHECK your roof and other surfaces for any damage or potential leaks that could go unnoticed until it is too late.
 2. CLOSE all windows and roof vents.
 3. TURN OFF 12-volt DC/120-volt AC/propane to the refrigerator; defrost and clean.

4. USE crumpled newspaper or open boxes of baking soda in the refrigerator to eliminate odors during storage.
5. SHUT OFF the propane cylinder valve(s).
6. COVER all external outlets/vents (furnace, exhaust, etc.) to prevent mice or other rodents from entering.
7. COVER the roof air conditioner (if so equipped).
8. DISCONNECT 120-volt AC power to the RV.
9. DO NOT use the leveling legs during storage.
10. DRAIN all water lines.
11. FLUSH, *then* DRAIN **ALL** holding tanks; fresh water, gray water, black water and the water heater.
12. DISCONNECT the battery cables from the auxiliary battery terminals & REMOVE all batteries from the RV.
 - **Store batteries in a place where they will not freeze.**
If a battery is frozen, it will no longer hold a proper charge.
13. WASH the interior and the exterior of your RV thoroughly.
14. STORE your RV indoors, under a roof or purchase a *breathable* cover for use during storage.
15. TO PREVENT weather checking and other UV damage, cover tires that are exposed to sunlight.

Snow removal

During the storage period, remove snow from the top of your RV to prevent damage to the unit's structure.



Damage from birds, rodents, insect, etc., is not covered under the Limited Base Warranty and Limited Structural Warranty applicable to your RV.

NOTICE

Excessive snow, 8" or more, or ice, 2" or more, places excessive weight on the RV roof. Remove excessive snow or ice as needed. Care **MUST** be exercised to not damage the roof material when removing snow & ice. Excessive weight can damage the roof, seals, etc. Water leaks and poor fit or operation are the results of this damage.

This page is intentionally blank.

Maintenance

Suggested Maintenance Checklist

Here is a quick reference list of suggested areas for regular maintenance. Review all manufacturer's operators manuals supplied with your RV to perform the maintenance items listed.

Prior to first trip

- INSPECT and reseal as needed.
- HAVE *your dealer* CHECK the propane system for leaks.
- CHECK wheel lug nuts at specified intervals to listed torque specifications, RE-TORQUE as needed.
- SANITIZE the fresh water system.
- TEST all safety alarms.

First two hundred miles

- CHECK wheel lug nuts at specified intervals to the listed torque specifications, RE-TORQUE as needed.
- HAVE a *Qualified Service Technician* adjust the brakes.

Each trip

- INSPECT and re-seal as needed.
- CHECK the auxiliary battery.
- CHECK running lights.
- CHECK tire pressure and wear, including spare.
 - *The tires should be COLD when checking the tire pressure.*
- CHECK wheel nuts at specified intervals to the listed torque values. RE-TORQUE as needed.
- FLUSH out water heater tank.
- TEST the brakes.
- TEST all safety alarms.

Required Maintenance Schedule							
Maintenance Item	Every trip	Monthly	Every 3 months	Every 6 months	Annually	Before /After Storage	Procedure to be Performed: Maintenance schedules are <i>minimum</i> requirements. Extended use, extreme temperatures, high humidity or other extreme conditions will require more frequent maintenance.
Appliances					●	●	Check settings & adjustments per manufacturers guide.
		●				●	Make sure burner tubes /vents are clean /unobstructed.
					●	●	Clean & sanitize.
Awnings						●	Wash with warm water and mild detergent.
					●	●	Clean moving parts & apply Silicone or Teflon based dry lube.
Axles / Suspension						●	Check U-bolts, springs & hangers for damage.
					●	●	Check torque - all bolts (<i>see mfg. guide for specs</i>).
			●				Inspect and lube wet bolts with a "squirt" of grease every 3 months (quarterly).
Baggage Doors		●				●	Confirm that doors seal tight and are not leaking.
			●			●	Spray lock tumblers with dry graphite.
Brakes / Wheel Hubs					●		Have brakes and hubs inspected by a certified RV service technician.
					●		Check amp draw / shoe wear / adjustment (<i>see mfg. guide for specs</i> .)
					●		Lube bearings every 12 months (<i>as required</i>).
Electrical System	●		●			●	Check and service batteries.
			●		●	●	Test all GFI outlets.
					●	●	Service generator (<i>if equipped</i>) per manufacturer's manual.
Entry Door(s)	●					●	Make sure door latches and locks function properly.
			●			●	Lube hinges with Silicone or Teflon based dry lube.
			●			●	Adjust screen door and latch.
Emergency Egress Window(s)	●	●				●	Open and close the <i>Emergency Egress Window(s)</i> every trip.
Entry Steps				●		●	Clean & apply Silicone or Teflon based dry lube.
Exterior Fiberglass / Metal			●			●	Wash with warm water & mild detergent.
				●			Apply non-abrasive wax (<i>except on decals</i>).
Exterior Moldings			●			●	Inspect sealant for voids / gaps / cracks and re-seal as necessary.
Frame / Underbelly					●	●	Check for damage, loose wires and debris. Clean as necessary.
			●			●	Check frame for chipped paint and rust, repaint as necessary.

Required Maintenance Schedule							
Maintenance Item	Every trip	Monthly	Every 3 months	Every 6 months	Annually	Before/After Storage	Procedure to be Performed: Maintenance schedules are <i>minimum</i> requirements. Extended use, extreme temperatures, high humidity or other extreme conditions will require more frequent maintenance.
Hitch / Coupler					●	●	Check for damage & wear. Clean and lubricate (with grease)
LP System					●		Have system tested for leaks by a qualified dealer.
					●		Have pressure and regulator setting checked by a qualified dealer.
Plumbing System			●		●	●	Check hoses, fittings and pipes for leak. Tighten as required.
					●	●	Lubricate termination gate valve cables with Silicone or Teflon based dry lube.
					●	●	Winterize system before storage (<i>in cold weather locations</i>)
	●				●		Drain Fresh Water Holding Tanks after every trip. Sanitize Annually (or as needed)
	●						Drain & Flush Black & Gray Water Holding Tanks
Roof And Roof Attachments			●			●	Inspect sealant for voids / gaps / cracks and re-seal as necessary.
				●		●	Clean roof with water and mild detergent.
					●	●	Clean and lube roof vent mechanisms with light oil.
Safety Equipment	●			●		●	Check operation of detectors - recharge and replace batteries every 6 months if equipped.
				●	●		Test & check fire extinguisher for proper charge.
	●	●				●	Test and confirm <i>Emergency Egress Window(s)</i> function properly.
Slide Rooms					●		Slideout room adjustment performed by a certified RV service technician.
	●						Check slide roof for debris - clear as necessary.
	●		●			●	Check and clean all seals.
Wheels & Tires	●		●			●	Check wheel lugs for proper torque.
			●			●	Inspect tires for wear / damage / etc.
	●	●				●	Check tire inflation pressure (<i>see tire label for pressures</i>).



Basic Troubleshooting

Air Conditioner (Roof)

Will not operate

- Make sure unit is turned on.
- Check circuit breakers in coach.
- Have your dealer check to see if there is proper voltage from shoreline or generator.

Unit runs, but coil freezes and compressor cycles too soon

- Control setting may be too low, cycles too soon.
- Make sure the filter is clean and unobstructed.
- Have the coolant level checked by a qualified service facility.

Does not get cold enough

- Start the unit before the day gets too hot.
- To offset heat gain:
 - Close all windows and blinds.
 - Keep entrance doors closed.
 - Use awnings.
 - Avoid using heat-producing appliances.
- Make sure the outside coil is not blocked or damaged.
- Have your dealer check to make sure you have the proper voltage.

Should your air conditioner still not work after completing the above checks, contact a qualified service facility to perform more extensive testing.

Electrical Power

No AC power to RV

- Check circuit breakers at power center.
 - The 120-volt circuit breaker may be OFF or *tripped*.
- Have a dealer check that there is power to the shoreline receptacle.

Furnace

Furnace does not ignite and/or cycles frequently

- Check that propane tank is full.
- Remove any obstruction over furnace exhaust.
- Inspect exhaust tube for any obstructions.
- Check fuse in fuse panel and replace if necessary.
- Make sure that return air grill is unobstructed. Remove anything that is stored in furnace compartment that could block airflow.
- Check that heat outlet registers are open and that register openings are unobstructed.
- Make sure that 12-volt power is present.
- Contact your dealer if the problem persists.

Interior Lights

Lights flicker

- Loose or defective bulb. Tighten or replace as needed.
- Converter is overheating. Open the cover to cool down and reduce the load by turning off some 12-volt lights.

Lights dim or are half bright

- Low battery connection. Check battery condition and recharge if necessary.
- Possible converter malfunction. Have converter checked by an authorized service center.
- Possible loss of ground. Check for loose wire connection.

Microwave

Will not operate

- Door open or timer OFF. Close door and turn ON timer.
- No power to oven. Check power supply and circuit breaker.



To Access the ON/OFF Switch, Remove the Outside Furnace Panel

Monitor Panel

No lights on panel when switch is pressed

- Check battery voltage and condition.
- Check fuse at the battery; if fuse is good have a dealer or qualified RV technician check the condition of panel.

Holding tank lights deliver false readings (i.e. 1/3 or 2/3 indication)

- Verify tank is empty.
- Debris may be built up across probes.
 - CLEAN and FLUSH tank using a solution of two-parts vinegar mixed to one-part water.

Propane indicator display indicates E or F all the time

- Ensure propane gas tank is full.
- If display reads **F**, check the wiring or sending unit for malfunction.
- Have it inspected by a certified technician.

Outside Receptacle

No power to outside receptacle

- Make sure you have power to the shoreline.
- Check breaker on generator.
- GFCI receptacle switch may be OFF or *tripped*.
 - Re-Set GFCI at receptacle in bathroom or kitchen.
- Check the breaker in the power center or panel box.
- Contact a dealer or qualified RV technician if problem is not resolved.

Oven

Oven slow to heat up, poor baking, poor ignition of burners, pilots won't stay lit, popping sound from top burners, carbon on pilot shield or burner flame *too low or too high*

- A **defective** Gas Pressure Regulator may cause these conditions. Have the regulator tested by your gas dealer or a certified RV technician.

Top burner or oven burner won't light or won't stay lit

- Check position of top burners and flash tubing.
- Clean clogged burner ports with a toothpick.
- See the oven manufacturer's instructions for proper care and maintenance.

Gas smell

- Check all connections with leak detector solution.

Food burns on the bottom

- Oven too full for proper circulation. Use smaller pans or put less food in the oven.

Portable Generator (Customer Supplied)**Starter engages while holding down the start button, but generator does not start**

- Generator may be out of fuel. (Generator will not operate when the fuel tank is less than $\frac{1}{4}$ full).
- Generator may be low on oil. Check the oil level.

When the generator start button is pushed, nothing happens

- Check that the battery disconnect switch button is pushed.
- Check 12 Volt fuse on generator.
- Reset circuit breaker if necessary.
- Contact your dealer or a qualified RV technician if problem is not resolved.

Generator starts, but lacks electrical power

- Breaker switches may be off or tripped at generator. Reset breaker if necessary.
- Breaker may be off or tripped inside power center. Reset main breaker if necessary.

Generator just makes clicking sound when trying to start

- Battery condition may be low. Recharge if necessary.
- Check for poor ground or battery connection.



Propane Gas

Smell gas in or around unit

- Propane tanks may be overfilled.

IF YOU SMELL PROPANE

1. **Extinguish any open flames, pilot lights *and* all smoking materials.**
2. **Do not touch electrical switches.**
3. **Shut off the propane supply at the container valve(s) or propane supply connection.**
4. **Open doors and other ventilating openings.**
5. **Leave the area until odor clears.**
6. **Have the propane system checked and leakage source corrected before using again.**

**FAILURE TO COMPLY COULD RESULT IN EXPLOSION
RESULTING IN DEATH OR SERIOUS INJURY**

Refrigerator

The control panel lights are not illuminated

- Check coach circuit breakers and GFCI receptacle.
- Verify that refrigerator is plugged into the 120-volt outlet.
- If using propane gas, verify house batteries have an adequate charge.

Lights are illuminating, but no cooling

- Use a proper power source that is available and cooling operation to specification.
- Make sure the refrigerator unit is level.
- Allow sufficient time for proper cool down and try to load with food that is *already* cold.
- Have a qualified RV technician check that the vents and chimney at the rear of the refrigerator are clear and unobstructed.
- Have a qualified RV technician make sure the burner jets or burners are not dirty or damaged.
- Have a qualified RV technician check the fuses in the black electrical box on the rear of the refrigerator.

Heavy frost buildup on the evaporator fins

- Defrost the freezer and refrigerator.
- Have the refrigerator checked by your dealer or a qualified RV technician.

Running Lights

Running lights not working

- Blown fuse. Replace fuse with one of the same ampere rating.
- Bad bulbs. Replace the bulbs with new.

Slideout

Room move in and out very slowly, binds or squeaks

- Lubricate the slide-out tubes and rollers with light spray lube.

Water is getting in at the bottom corners of the room

- Verify exterior seals are against the room at the top corners and not turned in when the room is out (horizontal seal overlaps vertical). Also, check for voids in the seal on the slide roof and side panels.
- Make sure weep hole in ramp pan is open and unobstructed.

Room will not move in or out

- Check the auto-resetting fuse located by the slideout motor. (*See the manufacturer's manual*).
- Check battery condition and state of charge. Recharge if necessary.

Rollers leave tracks in the carpet as the room extends

- IT IS NORMAL for the rollers to compress the nap of the carpet since they carry considerable weight. Raking the nap or vacuuming will solve this problem.

Termination Valve

Termination valve leaks

- Debris keeps valve from seating. Clear debris from and around valve O-ring set.
- Bad gasket. Have your dealer or qualified RV technician replace gasket with new.

TV Antenna

Poor TV reception

- Power jack is OFF. Turn ON power jack switch.
- Bad connections at TV or wall plate. Make sure the connections are good at both TV and wall plate.
- Cut or torn cable. Have your dealer or qualified RV technician replace bad cable where needed at TV and antenna.

Waste Tank

Waste tank (black) will not drain

- Buildup or debris in tank. Check for buildup in tank at stool.
- Always use a minimum amount of biodegradable RV toilet paper.
- Always use plenty of water when flushing.
- Check termination valve for proper operation.

Water Heater

Water heater will not fire up

- Check for obstructions in burner tube and exhaust.
- Check 12 Volt power for possible blown fuse.
- Bad circuit board. See your dealer.

Pressure temperature relief valve weeping

- Weeping or dripping at the relief valve, while water heater is running, does NOT mean it is faulty.

There is an odor that smells like rotten eggs

- If your fresh water source has a rotten egg odor, you will need to find another source of fresh water before flushing or refilling the entire RV water storage system.

To remove the hydrogen sulfide (rotten egg) odor:

1. TURN OFF your main water supply; that is, your pump or your water hookup source.
2. DRAIN your water heater tank by removing the drain plug. Approximately two quarts of water will remain in the bottom of the tank.
 - If the water drains slowly or sporadically (instead of flowing freely), OPEN the *Relief Valve* to allow air into the tank.
3. If the water still does not flow freely, take a small gauge wire or coat hanger and push through the drain opening to eliminate any obstructions.
4. AFTER completely draining the tank, FLUSH the entire system with a solution of 2-parts vinegar / 1-part water, from the *water inlet* all the way to the *holding tank*.
5. If you decide to use air pressure (55 PSI max.), it may be applied either through the inlet or outlet on the rear of the tank. It may also be applied through the *Relief Valve* port.
 - First remove the relief valve. You may then insert your air pressure through the relief valve support flange.
 - With the drain valve OPEN, the air pressure will force the remaining water out of the tank.
 - If air pressure is unavailable, you may FLUSH the tank with fresh water. Water should be pumped into the tank with the assistance of the on board water pump or with the assistance of external water pressure.
 - External pressure may be pumped into the unit either through the inlet or outlet found on the rear of the water tank, or using the relief valve inlet located on the front of the unit.
6. CONTINUE this flushing process for approximately five (5) minutes allowing ample time for the fresh water to agitate the stagnant water on the bottom of the tank and force the deposits through the drain opening.
7. AFTER steps 1-6 (above) are complete, CLOSE the drain plug *and* the *Relief Valve*. REFILL the tank with fresh water, CIRCULATE, and RINSE.

If you use your vehicle frequently or for long periods of time, flushing the water heater several times a year will prolong the life of the water heater storage tank.

Water Pump

Pump will not start

- Check that house battery disconnect switch is ON.
- Check pump switch at monitor panel.
- Check fuse in power center.
- Check to see if water is frozen.

Will not prime, sputters (no discharge, but the motor runs)

- Check that there is a sufficient amount of fresh water,
 - Use the Monitor Panel to check the fresh water tank fill level.
- Check that there is not trapped air in the hot water heater.
- Check for frozen water lines or water tank.

Pump will not shut off, runs when faucet is closed

- Turn off the pump or city water supply.
- Check for damp areas around plumbing appliances.
- Check plumbing for leaks
- Inspect toilet for leaky valves.
- Have the pump checked by your dealer or a qualified RV technician.

Water System

Wet areas near water connections, pump runs while the faucets are closed, and no other fresh water fixtures are being used.

- There is a possible leak,
- CLOSE all low point water drains and tank drains.
- TURN OFF all fixtures.
- Check all fixtures and connections for tightness.
 - DO NOT over tighten fittings as this may cause additional leakage.

Glossary

AC ELECTRICITY—Alternating current also known as shoreline power. For purposes of this manual, it refers to 120-volt AC (abbreviated 120 VAC).

AMP—Short for ampere, the electric current unit of measure. RV sites with electric hookup will specify the maximum amps supported, which generally come in units of 20, 30, or 50 amps. The RV power connector must match the various plugs of the site amp rating.

ANODE ROD—An anode rod, when used in a water heater, attracts corrosion causing products in the water. These products attack the anode rod instead of the metal tank itself. The anode rod should be inspected yearly and changed when it is reduced to about 1/4 of its original size. The rods are used in steel water heater tanks - an aluminum tank has an inner layer of anode metal to accomplish the same thing. Anode rods should not be installed in aluminum tanks!

AUXILIARY BATTERY—For purposes of this manual, the term refers to the 12-volt DC group 27 deep cycle battery (customer purchased) that should be installed in your RV.

AWNING—A roof-like structure made of canvas or other artificial materials which extends from the RV body to provide shade. Awnings are generally placed over entrances. Some extend and stow manually while others are operated electrically.

BLACK WATER—Term associated with the sewage holding tank. The toilet drains directly into this tank.

BLUE BOY—Also known as a honey pot. Refers to a portable waste holding tank that has wheels on one end. These tanks often are manufactured out of blue plastic, hence the nickname.

BOON DOCKING—Also known as dry camping. Camping without electrical and water hookups.

BREAKAWAY SWITCH—An electrical switch on trailers designed to engage the breaks in case the trailer breaks away from the tow vehicle. The switch is connected by a cable to the tow vehicle. Breakaway is detected when the switch cable is pulled out during vehicle separation.

BRAKE CONTROLLER—A device (customer supplied) mounted under the dash of a towing vehicle to control the braking system of the RV. Most brake actuators are based on a time delay application; the longer the brakes are applied tighter the trailer brakes react

BRITISH THERMAL UNIT (BTU)—Measurement of heat that is the quantity required to raise the temperature of one pound of water 1°F. RV air-conditioners and furnaces are BTU-rated.

CAMBER (WHEEL ALIGNMENT)—The number of degrees each wheel is off of vertical. Looking from the front, tops of wheels farther apart than bottoms means “positive camber”. As the load pushes the front end down, or the springs get weak, camber would go from positive to none to negative (bottoms of wheels farther apart than tops).

CAMPER—For purposes of this manual, this term refers to your fifth wheel RV.

CAMPING—An outdoor recreational activity involving the spending of one or more nights in a tent, primitive structure or RV at a campsite with the purpose of getting away from civilization and enjoying nature.

CAMPSITE—The term usually means an area where an individual or family might go camping.

CARBON MONOXIDE—A colorless, odorless and poisonous gas.

CARGO WEIGHT—The actual weight of all items added to the Curb Weight of the vehicle or trailer. This includes personal cargo, optional equipment, and tongue or king pin weight.

CARGO CARRYING CAPACITY (CCC)—Equal to GVWR minus each of the following: UVW, full fresh (potable) water weight (including water heater), full propane weight and SCWR.

CITY WATER—Term associated with the water supply you hook up to at the campsite. It is called city water because water is pulled from a central outside source (like a city) and not the fresh water tank.

CONDENSATION—A result of warm moisture laden air contacting the cold window glass. Keeping a roof vent open helps to reduce the humidity levels. Added roof vent covers help to prevent cold air from dropping down through the vent while still allowing moist air to escape. Using the roof vent fan when showering or the stove vent fan when cooking also helps prevent excess moisture buildup.

CONVERTER—A device that converts 120 volt A/C (alternating current) to 12 volt DC (direct current). The RV devices mostly run on 12 volt DC power that is supplied by the battery, which allows the RV to function independently. When “shore power” (an electrical supply) is available, the converter changes the voltage from 120 to 12 volt to supply the appliances and to recharge the battery.

CURB WEIGHT—The actual weight of a vehicle or trailer, including all standard equipment, full fuel tanks, full fresh water tanks, full propane bottles, and all other equipment fluids, but before taking on any persons or personal cargo.

CURBSIDE—This refers to the side of the camper that faces the curb when parked. Also referred to as the door side or DS.

DC ELECTRICITY—Direct current also known as auxiliary battery power. For purposes of this owner’s manual, it refers to 12-volt DC (abbreviated 12 VDC).

DEALER—For purposes of this manual, this refers to the independent dealer authorized to sell and/or service your camper by Grand Design RV. This term will be used in this context unless specified otherwise.

DINETTE—Booth-like dining area. Table usually drops to convert unit into a bed at night.

DRAIN TRAP—This is the curve that is in all drains. Water is trapped in the curve and creates a barrier so tank odors cannot escape through the drain.

DRY CAMPING—Camping when there is no city water hookup or shore power (i.e., using only the water and power available in the camper and not from any other source).

DRY WEIGHT—The actual weight of a vehicle or trailer containing standard equipment without fuel, fluids, cargo, passengers, or optional equipment.

DSI (Direct Spark Ignition)—This term refers to the method of igniting the main burner on a propane fired appliance. The burner is lit with an electric spark and the flame is monitored by an electronic circuit board. This ignition system is used in refrigerators, furnaces and water heaters. There is now a version of stove tops that light the burners with a DSI ignition.

DUAL ELECTRICAL SYSTEM—RV equipped with lights, appliances which operate on 12-volt battery power when self-contained, and with a converter, on 110 AC current when in campgrounds or with an on-board generator

DUALY—A truck having two wheels on each side of the rear axle for a total of four wheels

DUCTED A/C—Air conditioning supplied through a ducting system in the ceiling. This supplies cooling air at various vents located throughout the RV.

DUCTED HEAT—Warm air from the furnace supplied to various locations in the RV through a ducting system located in the floor. (Similar to house heating systems).

DUMP STATION—Site where you drain your gray water (waste) and your black water (sewage) tanks. In most states, it is illegal to drain your tanks anywhere except dump stations.

DUMP VALVE—Another name for the T-handle valve used to release and drain the black tank (sewage) and gray tank (waste).

EGRESS WINDOW—The formal name for the emergency escape window. Egress windows are identified by their labeling.

FIFTH WHEEL (FW)—A trailer and hitch configuration connected to the tow truck directly above the rear axle by way of a special fifth wheel hitch. This causes several feet of the connected trailer to hang over the tow truck, placing about 15 to 25% of the trailer's weight on the rear axle of the truck. Commercial trucks and trailers use this hitch configuration. Also commonly spelled as 5th wheel.

FIVER—Another name for a fifth wheel RV.

FRESH WATER—The fresh water system provides potable water to the fresh water tank, kitchen sink, shower, bathroom lavatory, toilet, water heater and outside shower.

FRESH WATER TANK—Tank for holding fresh water for drinking, cooking, and bathing while not connected to a city water supply.

FULL HOOK-UP SITE—A campsite that has city water, shore power and sewer hook-ups or connections available.

FULL TIMERS or FULL TIMING—The term used for people who live in their RV full time, or at least the vast majority of their time.

GALLEY—The kitchen in an RV.

GENERATOR—An engine powered device fueled by gasoline or diesel fuel, and sometimes propane, for generating 120-volt AC power.

GENSET—Abbreviation for generator set.

GOOSENECK—A trailer and hitch configuration connected to the tow truck directly above the rear axle by way of a standard ball hitch in the truck bed and a vertical, slender arm on front of the trailer. Gooseneck hitching is common on horse and utility trailers, but rarely found on RV's.

GRAY WATER—Term associated with the waste water holding tank. Water from the sink drains, shower and washer/dryer (if so equipped) go into this tank.

GROSS AXLE WEIGHT RATING (GAWR)—The MAXIMUM ALLOWABLE WEIGHT each axle assembly is designed to carry, as measured at the tires, therefore including the weight of the axle assembly itself. GAWR is established by considering the rating of each of its components (tires, wheels, springs, axle), and rating the axle on its weakest link. The GAWR assumes that the LOAD IS EQUAL ON EACH SIDE.

GROSS CARRYING CAPACITY (GCC)—Means the maximum carrying capacity of your camper. The GCC is equal to the GVWR minus UVW. The GCC will be reduced by the weight of fresh water or other tanks, propane, occupants, personal items or dealer installed accessories.

GROSS COMBINED WEIGHT RATING (GCWR)—The MAXIMUM ALLOWABLE COMBINED WEIGHT of the tow vehicle and attached towed vehicle. GCWR assumes that both vehicles have functioning brakes, with exceptions in some cases for very light towed vehicles, normally less than 1,500 pounds. (Check your tow vehicle's towing guide.)

GROSS TRAILER WEIGHT RATING (GTWR)—The MAXIMUM TOWED VEHICLE WEIGHT. Each component (receiver, drawbar, ball) of a ball-type hitch has its own rating. Some ball-type hitches have separate ratings when used with a weight distributing system.

GROSS VEHICLE WEIGHT RATING (GVWR)—The MAXIMUM ALLOWABLE WEIGHT of the fully loaded vehicle, including liquids, passengers, cargo, and the tongue weight of any towed vehicle.

HEAT EXCHANGER—A device that transfers heat from one source to another. For example, there is a heat exchanger in your furnace - the propane flame and combustion products are contained inside the heat exchanger that is sealed from the inside area. Inside air is blown over the surface of the exchanger, where it is warmed and the blown through the ducting system for room heating. The combustion gases are vented to the outside air.

HEAT STRIP—A heat strip is an electric heating element located in the air conditioning system with the warm air distributed by the air conditioner fan and ducting system. They are typically 1500 watt elements (about the same wattage as an electric hair dryer) and have limited function. Basically they "take off the chill."

HIGH PROFILE—A fifth-wheel trailer with a higher-than-normal front to allow more than 6 feet of standing room inside the raised area.

HITCH—The fastening unit that joins a movable vehicle to the vehicle that pulls it.

HITCH WEIGHT—The amount of the camper's weight that rests on the tow vehicle. It should be approximately 12% - 15% with conventional trailers; approximately 18% -21% for fifth wheels.

HOLDING TANKS—There are three different holding tanks on most RVs; fresh water tank, gray water tank and black water tank. The fresh water tank holds fresh water that can be stored for later use. The gray water tank holds the waste water from the sinks and showers. The black water tank holds the waste from the toilet.

HONEY WAGON—Euphemism for the sewage pumping truck. Honey wagons are used to empty RV holding tanks in places where full hookups and dump stations are not available.

HOOKUPS—The ability of connecting to a campground's facilities. The major types of hookups are electrical, water and sewer. If all three of these hookups are available, it is termed full hookup. Hookups may also include telephone and cable TV in some campgrounds.

HOUSE BATTERY—One or more batteries in a RV for operating the 12 volt lights, appliances, and systems. House batteries can be 12 volt units tied in parallel or pairs of 6 volt batteries tied in series (to double the voltage). The term house battery is of more significance in motor homes because they contain one or more other batteries for the operation of the engine, referred to as the chassis or starting batteries.

HULA SKIRT—Term used for a type of dirt skirt accessory some RVers use on the back of their motorhome to aid in the protection from debris thrown from their rear wheels to the vehicles directly behind them or being towed behind them. This dirt skirt is usually the length of the rear bumper and resembles a 'short' version of a Hawaiian 'hula-skirt', hence the term.

INVERTER—An inverter is a device that changes 12 volt battery power to 120 volt AC power. It is used when "boon docking" (camping without hookups) to power certain 120 VAC only devices like a microwave oven. The amount of available power depends on the storage capacity of the batteries and the wattage rating of the inverter.

IRON RANGER—A fee collection box used at campgrounds that do not have full time attendants. Upon entrance to the campground, you deposit your nightly fee(s) in an envelope with your name and site number and drop this in the collection box. At sometime during the day, a park ranger will make rounds of the campgrounds and collect the fees. You will often see these in National Park and National Forest campgrounds.

ISLAND QUEEN or ISLAND KING—A king or queen-sized bed with walking space on both sides.

JACKKNIFE—90° angle obtained from turning/backing fifth wheel or travel trailer with tow vehicle. Jackknifing a short bed truck towing a fifth wheel without the use of a slider hitch or extended fifth wheel pin box can result in damage to the truck cab or breaking out the back window of the truck cab from the truck and fifth wheel “colliding”.

KING PIN—The pin by which a fifth wheel trailer attaches to the truck. It slides into the fifth wheel hitch and locks in place.

KING PIN WEIGHT—The actual weight pressing down on the fifth wheel hitch by the trailer. The recommended amount of King Pin Weight is 15%-25% of the GTW, also called Pin Weight.

LAMINATE—A sandwich of structural frame members, wall paneling, insulation and exterior covering, adhesive-bonded under pressure and/or heat to form the RV’s walls, floor and/or roof.

LANDING GEARS—See Leveling Jack.

LEVELING—Positioning the RV in camp so it will be level, using ramps (also called levelers) placed under the wheels, built-in scissors jacks, or power leveling jacks.

LEVELING JACK—A jack lowered from the underside of trailers and motor homes for the purpose of leveling the vehicle. A leveling jack is designed to bear a significant portion of the RV’s weight.

LP GAS—Liquefied Petroleum Gas, commonly written as “LP Gas”. Two examples of LP Gas are propane and butane. LP Gas is heavier than air in gas form and about half the weight of water in liquid form. LP gas is used to fuel appliances in the RV, such as the stove, oven, water heater and refrigerator. Propane tanks are usually rated as pounds or gallons.

LOW POINT—The lowest point in the plumbing. Drains are placed here so that water will drain out of the lower end of the camper when flushing or winterizing the water system. These drains must be closed when you fill the water tank.

MOTORHOME (MH)—A motor vehicle built on a truck or bus chassis and designed to serve as self-contained living quarters for recreational travel.

NET CARRYING CAPACITY (NCC)—The MAXIMUM WEIGHT of all personal belongings, food, fresh water, propane, tools, dealer installed accessories, etc., that can be carried by the RV.

NON-POTABLE WATER—Water NOT suitable for human consumption.

OEM—This refers to the original equipment manufacturer of the individual appliances or components.

PARK MODEL—A travel trailer that requires park facilities to function. It lacks holding tanks and dual-voltage appliances, requiring to be plugged into water, sewage, and electrical facilities. A park model is more of a small mobile home than a recreational vehicle, in appearance and function.

PART TIMERS—The term used for people who use their RV more than usual (more than just a few weekend trips a year), but who still use it less than full time.

PATIO MAT—Carpet or woven mat for use on ground outside of RV. Used whether or not a concrete patio pad is available where camping.

PAYLOAD CAPACITY—The maximum allowable weight that can be placed in or on a vehicle, including cargo, passengers, fluids and fifth-wheel or conventional hitch loads.

PILOT—A pilot is a small standby flame that is used to light the main burner of a propane fired appliance when the thermostat calls for heat. Pilots can be used in furnaces, water heaters, refrigerators, ovens and stove tops.

PORPOISING—A term used to define the up and down motion in an RV while traveling

POWER SOURCE—Also referred to as shore power, this refers to the receptacle outlet you are using to plug in your shoreline power cord. This can be a campsite power box or electrical box, a residential receptacle outlet specifically wired for your camper or a generator (customer supplied).

PRIMITIVE SITE—A campsite that may have city water, shore power or sewer hook-ups but not all of them; primitive sites may have no hook-ups or connections at all.

PROPANE—LPG, or liquefied petroleum gas, used in RVs for heating, cooking and refrigeration. Also called bottle gas, for manner in which it is sold and stored. This is the proper term in the RV industry when referring to “LP Gas.”

PULL-THROUGH SITES—Campsites you can drive through and park (without having to back up into the site).

REFER—Slang for “refrigerator”. Refrigerators are often found in either a “two-way” or “three-way” operating mode. Two-way: has a gas mode and an AC mode. Three-way: has a gas mode, AC mode, and 12v DC mode. The coolant used in RV refrigeration is ammonia. The two most common manufacturers of RV refrigerators are Norcold and Dometic.

RIG—What many RVers call their units.

ROADSIDE – The side of the trailer that faces the road when it is parked. Also called the Streetside, Off-Door Side or ODS.

ROOF AIR CONDITIONING—Air conditioning unit mounted on roof of RV, to cool the RV when it is parked. When moving, most RVs are cooled by separate air conditioning units which are components of the engine, or they may be cooled by a roof top if a proper size generator is installed.

RV—Short for Recreation Vehicle, a generic term for all pleasure vehicles which contain living accommodations. Multiple units are RVs and persons using them are RVers.

RVDA—Abbreviation for Recreational Vehicle Dealer’s Association.

RVIA—Abbreviation for Recreational Vehicle Industry Association

SELF CONTAINED—RV which needs no external electrical, drain or water hookup. Thus, it can park overnight anywhere. Of course, self-contained units can also hook up to facilities when at campgrounds.

SANITIZATION—Refers to the camper’s fresh water system that has been sanitized with chlorine bleach before use or after storage.

SHORELINE POWER CORD—This is the electrical power cord that runs from the camper to the campsite shore power outlet.

SLEEPING CAPACITY WEIGHT RATING (SCWR)—The manufacturer’s designated number of sleeping positions multiplied by 154 pounds (70 kilograms).

SLIDEOUT—A compartment added to an RV to increase interior space. It slides into the body during travel and slides out when parked.

SNOWBIRD—Term for someone in a northern climate that heads “south” in winter months.

STINKY SLINKY—Slang for the sewer hose, constructed from a spiral wire covered with vinyl. One end attaches to the RV piping and the other into the local sewer dump facilities

STREETSIDE – The side of the trailer that faces the street when parked. Also called the Roadside, Off-Door Side or ODS.

SURGE PROTECTOR—Device (customer supplied) that is installed at the power supply location designed to prevent “surges” or “spikes” in electrical current that may damage the RV’s electrical/electronic components.

SWAY—Fishtailing action of the trailer caused by external forces that set the trailer’s mass into a lateral (side-to-side) motion. The trailer’s wheels serve as the axis or pivot point. Also known as “yaw.”

THERMOCOUPLE—A thermocouple is a device that monitors the pilot flame of a pilot model propane appliance. If the pilot flame is extinguished the thermocouple causes the gas valve to shut off the flow of gas to both the pilot flame and the main burner.

TIP OUT—The term used for an area or room in an RV that tips out for additional living space. The Tip-Out was generally used in older RVs. Newer RVs mainly use a slide-out.

TIRE RATINGS—The MAXIMUM LOAD that a tire may carry is engraved on the sidewall, along with a corresponding COLD inflation pressure. A reduction in inflation pressure requires a reduction in load rating. Tire manufacturers publish charts that establish the load capacity at various inflation pressures.

TOE (WHEEL ALIGNMENT)—Toe is the measure of whether the front of the wheels (looking down from the top) are closer (toe-in) or farther (toe-out) than the back of the wheels.

TONGUE WEIGHT, TONGUE LOAD, VERTICAL LOAD (TWR/TLR/VLR)—Tongue Weight, Tongue Load, Vertical Load Rating Different terms for the MAXIMUM VERTICAL LOAD that can be carried by the hitch UNLOADED.

TRAILER BRAKES—Brakes that are built into the trailer axle systems and are activated either by electric impulse or by a surge mechanism. The overwhelming majority of RVs utilize electric trailer brakes that are actuated when the tow vehicle's brakes are operated, or when a brake controller is manually activated. Surge brakes utilize a mechanism that is positioned at the coupler, that detects when the tow vehicle is slowing or stopping, and activates the trailer brakes via a hydraulic system (typically used on boats).

TRAVEL TRAILER (TT)—Also referred to as “conventional trailers,” these types of rigs have an A-frame and coupler and are attached to a ball mount on the tow vehicle. Travel trailers are available with one, two or three axles. Depending upon tow ratings, conventional trailers can be towed by trucks, cars or sport-utility vehicles.

UMBILICAL CORD—Wiring harness which connects the trailer to the tow vehicle during transport. The umbilical cord supplies the trailer with DC power for charging the batteries and operating DC equipment. It also operates the trailer brakes and signal lights. (Also referred to as the 7-way power cord.)

UNDERBELLY—The RV's under-floor surface, which is protected by a weatherproofed material.

UTQGL (UNIFORM TIRE QUALITY GRADE LABELING)—A program that is directed by the government to provide consumers with information about three characteristics of the tire: tread wear, traction and temperature. Following government prescribed test procedures, tire manufacturers perform their own evaluations for these characteristics. Each manufacturer then labels the tire, according to grade.

UV DEGRADATION—A breaking down of material due to the sun's harsh ultraviolet rays.

UNLOADED VEHICLE WEIGHT (UVW)—The WEIGHT of a vehicle as built at the factory with full fuel, engine (generator) oil and coolants. It does not include cargo, fresh water, propane, occupants, or dealer installed accessories.

WALLY WORLD—Slang term used by RVers to describe a Wal-Mart.

WASTE WATER TANKS—The gray water tank holds the waste water from the sinks and showers. The black water tank holds the waste from the toilet.

WATER PRESSURE REGULATOR—Device (customer supplied) installed on the water hose attached to city water to limit the water pressure entering the RV. Most regulators limit water pressure to 40 psi.

WEEKENDERS—People who own their RV's for weekend and vacation use.

WEIGHT & LOAD—These terms are generally used interchangeably.

For the purposes of understanding RV applications:

- Vehicles have **WEIGHT**, which impart **LOADS** to tires, axles and hitches.
- Scale measurements taken when weighing, are **LOADS** carried by the tires. The measured **LOADS** are used to calculate Gross Combination Weight (GCW) Gross Vehicle Weight (GVW), Gross Axle Weight (GAW), and Hitch Loads.

WET WEIGHT—The weight of the vehicle with the fuel, freshwater and propane tanks full.

Note these important weights:

Propane	•	4.25	lbs. per gallon
Water	•	8.3	lbs. per gallon
Gasoline	•	6.3	lbs. per gallon
Diesel fuel	•	6.6	lbs. per gallon

WIDE BODY—An RV having an external body width greater than 96 inches (8 feet).

The most common wide-body widths are 100” and 102.”

WINTERIZED—Refers to a camper that has been prepared for storage. The water systems have been drained and RV antifreeze has been added to protect the water lines and drains. The low point drains should be in the open position.

WORK CAMPER—A person living in an RV and working. Many spell it as “workamper” after the website and service by that name.

YAW—Fishtailing action of the trailer caused by external forces that set the trailer’s mass into a lateral (side-to-side) motion. The trailer’s wheels serve as the axis or pivot point. Also known as “sway.”

Index

7-Way Wire Harness	70
12-Volt DC System	83
12-Volt Fuse Panel	84
30-Amp or 50-Amp Power Cord	79-80
120-Volt AC System	80
120-Volt Circuit Breakers81
A	
Air Quality	39-40
Appliances	119
Auxiliary Battery	84
Awning.	128-131
B	
Battery Disconnect Switch	86
Battery Monitor	88, 89
Black/Grey Water Systems	106
Black Tank Flusher	110
Breakaway Switch	69
C	
Carbon Monoxide Alarm	36
Carbon Monoxide (CO) Poisoning	35
Cargo Carrying Capacity Label51
Chemical Sensitivity & Outgassing41
Cleaning the Exterior.	146-149
Cold Weather Use	45
Condensation.	42-43
Cooking With Propane	116
D	
Draining the Fresh Water System	100
E	
Electrical Load Ratings87
Emergency Egress Window	33
Exterior Care	146

F

Federal Certification Label 51
 Fire Extinguisher 32
 Fire Safety 31
 Formaldehyde 41
 Fresh Water Connections 94
 Fresh Water System 91
 Furnace 126

G • I

Garage. 136
 Interior Care. 141

M

Maintenance Checklist, Suggested 155
 Maintenance Schedule, Required 156-157
 Maximum Load Rating 57
 Monitor Panel 92

P

Patio Rail Kit. 138-140
 Pet Safety 30
 Propane Gas (LP) Alarm 37-39
 Propane Leak Test 113
 Propane Regulator 115
 Propane System 111

R

Ramp Door 136
 Roof 150
 Roof Vents 126, 150

S

Safety Precautions 47, 48
 Sanitizing the Fresh Water System 94-95, 101
 Slideout Systems 132
 • Lippert Through Frame Electric 134-135
 Smoke Alarm 34
 Solar Docking Port 88
 Solar Power Charging System 88

T

Thermostat	127
Tire And Loading Information Label.	51, 57
Tire Safety/Tire Maintenance	56- 62
Tire Tread	62
Tire Warranty	61
Toilet.	106
Towing & Leveling	67
Troubleshooting	158
TV Roof Antenna	123

W

Warranty, (1) One Year Limited Base	13
Warranty, (3) Three Year Limited Structural	19
Warranty Service	9, 11
Warranty Service, Emergency.	10
Water Heater	96- 98
• Bypass Valves.	98, 100-102, 104
• Pressure & Temperature Relief Valve	97
Weighing Your Tow Vehicle & RV	54
Weight Ratings & Definitions	50
Wheel Nut Torque	64
Windows.	150
Winterization Valve	105
Winterizing /RV Storage Preparation	86, 152
Winterizing the Plumbing System.	101-103, 105



Corporate Office
11333 County Road 2
Middlebury, IN 46540
USA

(574) 825-8000
www.granddesignrv.com