

# *Reflection*<sup>®</sup>

BY GRAND DESIGN

REFLECTION FIFTH WHEEL  
**OWNER'S MANUAL**







Welcome to Our Family!

Thank you for purchasing a quality built Grand Design recreational vehicle and choosing the RV lifestyle as a family friendly form of leisure, recreation and fun. It is the intent of the Grand Design RV Team and our Dealer Partners to do our absolute best to assure that you enjoy a positive ownership experience and capitalize on all the exciting opportunities this "Grand" lifestyle has to offer.

Your new Grand Design RV has been designed and built to our personal high standards as well as those of the Recreational Vehicle Industry Association. In addition, our products meet or exceed all applicable state and federal regulations, standards and requirements in order to assure your safety.

Please thoroughly read and understand the content of this Owner's Manual and the various component manufacturer manuals that came with your RV. It is imperative for your personal safety that you become familiar with and learn how to properly operate the various systems, appliances and components included in your RV. Read all cautions, warnings and notices very carefully. Familiarize yourself and your family with the safety features built into your RV, and what actions and steps are necessary to assure safe camping. Always place the safety of you and your family first.

Please carefully read the Limited Base Warranty and Limited Structural Warranty that comes with your new RV. Be sure to understand the extent of your coverage and duration as well as the various exclusions and limitations that may apply. In addition, please understand the ongoing maintenance and upkeep requirements that need to be performed for your warranty to remain in effect. Failure to perform required maintenance could void your warranty. Your new RV may have additional warranties provided by the various component suppliers that extend beyond the Limited Base Warranty. Please be sure to read all component warranty information found in your Owner's Packet and submit any required registration forms.

Again, thank you from Grand Design RV and your Grand Design RV Dealer for your purchase. We wish you many safe and enjoyable journeys in your new RV and a lifetime of fond memories.

This page is intentionally blank.



## Fifth Wheel Owner's Manual

### Table of Contents

Introduction . . . . .	5
Reporting Safety Defects . . . . .	10
Service & Warranty . . . . .	11
Grand Design RV One Year Limited Base Warranty. . . . .	17
Grand Design RV Three Year Limited Structural Warranty . . . . .	23
Component Supplier Contact Information . . . . .	30
Component Manufacturer Warranty Information . . . . .	31
Occupant Safety. . . . .	33
Pre-Travel Information. . . . .	53
Towing & Leveling . . . . .	69
Electrical Systems . . . . .	83
Plumbing Systems. . . . .	109
Nautilus P1 Manual . . . . .	125
Nautilus P2 Manual . . . . .	133
Propane System . . . . .	136
Appliances . . . . .	145
Electronics . . . . .	148
Heating & Cooling . . . . .	151
Slideout Systems . . . . .	154
Hide-a-bed Sofa. . . . .	163
Interior Care . . . . .	165
Exterior Care . . . . .	170
Basic Troubleshooting. . . . .	178
Glossary . . . . .	188
Index . . . . .	198
Required Maintenance Schedule . . . . .	202

This page is intentionally blank.

# Introduction

## About This Manual

The purpose of this manual is to serve as guide to normal operation, safety, care, and maintenance of your recreation vehicle (RV). The information in this manual is accurate at the time of publication but is subject to change without notice. Photographs, drawings, components, and systems described may not represent what is actually in your RV due to ongoing upgrades and improvements.

There is nothing in this manual that creates any warranty, express or implied. Information in this manual is not meant in any way to supplement, modify, or alter the terms and conditions of your Limited Base and Structural Warranties, or any component manufacturer warranties.

Procedures outlined in this guide are typical for normal operating conditions. You are responsible for the safe operation and use of your RV, and we have tried to include information to assist you. There are occasional tips to help you enjoy the recreational lifestyle; however, this guide is not intended to teach you how, or where, to camp.

If you have any questions, concerns, or require assistance regarding any aspect of your RV, please contact your dealer or Grand Design RV.

### Contact Information:

Website: [www.granddesignrv.com](http://www.granddesignrv.com)  
Email: [customerservice@granddesignrv.com](mailto:customerservice@granddesignrv.com)  
  
Phone: (574) 825-8000  
Fax: (574) 825-9700  
  
Address: Customer Service  
Grand Design RV  
11356 County Road 2  
Middlebury, IN 46540



Owner Information Package



This manual and the owner information package should be considered a permanent part of the RV. If the RV is sold, both should remain with the RV for the next owner.

## Owner Information Package

The Owner Information Package contains the manual and registration cards for several individual components of your new Reflection Fifth Wheel (FW).

- It is critical that you register and activate each component warranty within the prescribed time limits to avoid loss of warranty coverage.
- Some component manufacturers offer warranties beyond the Grand Design Limited Base and Structural Warranties.
- Other components are warranted separately and exclusively by the individual component manufacturer, and are therefore excluded from our Limited Base and Structural Warranties.

**It is important that you read and understand the information in this manual and your Owner Information Package before using your RV.**

## Manufacturing Certification

Grand Design RV is subject to frequent and random audits to ensure our RVs are constructed to the thorough safety and manufacturing codes, standards and regulations established by the Recreation Vehicle Industry Association (RVIA), and Transport Canada.

Either an RVIA or CSA Group (formerly the Canadian Standards Association or CSA) label is affixed to the sidewall next to the entry door to confirm your RV has been constructed to these exacting codes and standards. RVs built for sale in Canada may differ to conform to Canadian codes.



This NOTE symbol is used to identify special attention items, like useful tips, reminders or maintenance items.



## The Vehicle Identification Number

The 17-digit vehicle identification number (VIN) for your RV is stamped on a metal tag permanently attached to the pin box. It is also listed on the Federal Certification Label. A breakdown of a typical Grand Design RV VIN is shown in the example below:

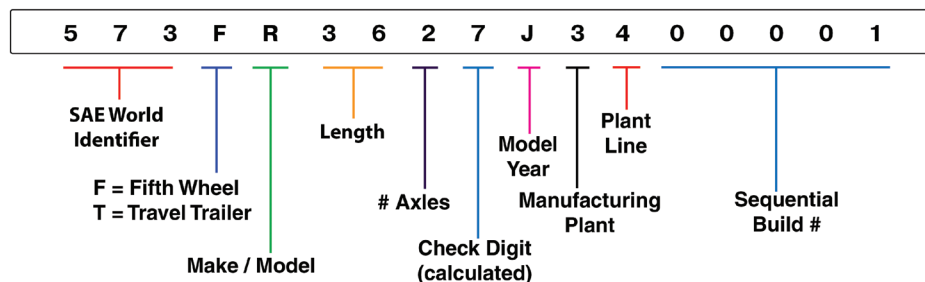

### SAE World Identifier:

573 — Grand Design RV

### Make / Model:

R — Reflection  
S — Solitude  
M — Momentum  
E — Imagine  
T — Transcend

### Length:

The number listed falls within a predetermined, specified grouping that does not indicate the actual measured length of your RV.

### Model Year:

H — 2017  
J — 2018  
K — 2019  
L — 2020



The last 8 digits of the VIN number are also the RV's serial number. For the example shown, the serial number is J3400001.



Various safety and information labels are attached to surfaces both inside and outside your RV. These labels are permanent and should not be removed or relocated for any reason.

## Safety Precautions

Nothing is more important than the personal safety of you, your family and others. Safety encompasses several areas related to the RV experience. This includes driving/towing safety, occupant safety, operational safety, environmental safety, and more. Any time you are dealing with carbon monoxide producing appliances, propane gas, electricity and other hazards it is critical that safety become your number one priority in and around your recreational vehicle.



The Safety Alert Symbol is used to alert you to potential personal injury hazards. It is imperative that you read, understand and abide by these safety alerts and messages to avoid possible personal injury or death.



### **DANGER**

DANGER indicates a hazardous situation which, if not avoided, will result in death or serious injury.



### **WARNING**

WARNING indicates a hazardous situation which, if not avoided, could result in death or serious injury.



### **CAUTION**

CAUTION indicates a hazardous situation which, if not avoided, could result in minor or moderate injury.

## NOTICE

NOTICE is used to address practices not related to physical injury. This applies to hazardous situations involving property damage only.

### Additional Terminology Used

**[Customer Supplied]** This denotes aftermarket items not installed or included by Grand Design RV. Items noted as “customer supplied” are not covered by the Limited Base and Structural Warranties. The inclusion of items noted as “customer supplied” does not imply or suggest the availability, application sustainability, or inclusion for any specific unit.

**[If so equipped]** This denotes items that may be installed by Grand Design on particular RVs. Additionally, some items noted as “if so equipped” can only be included during the manufacturing phase and cannot be added at a later date. The inclusion of items noted as “if so equipped” does not imply or suggest the availability, application sustainability, or inclusion for any specific unit.

**[Optional]** This denotes items that may be an option on all or particular models. Additionally, some optional items can only be included during the manufacturing phase and cannot be added at a later date. The inclusion of optional items does not imply or suggest the availability, application sustainability or inclusion for any specific unit.

## Reporting Safety Defects

### In the United States

If you believe your vehicle has a defect, that could cause an accident, injury or death, you should immediately inform the **National Highway Traffic Safety Administration (NHTSA)**, and Grand Design RV.

If the NHTSA receives similar complaints, they may open an investigation. If they determine that a safety defect exists in other vehicles, a recall and remedy campaign may be ordered. The NHTSA does not become involved in individual cases between you, your dealer, or Grand Design RV.

To contact the **NHTSA**,

Website: [www.safercar.gov](http://www.safercar.gov)

Address: NHTSA Headquarters  
Attn: Administrator  
1200 New Jersey Avenue, SE  
Washington DC 20590

Toll-free Vehicle  
Safety Hotline: 1-888-327-4236

TTY: 1-800-424-9153

Additional motor vehicle safety information is available online at [www.safercar.gov](http://www.safercar.gov)

### In Canada

If you believe that your vehicle has a defect, which could cause a crash or could cause injury or death, you should immediately inform Transport Canada's Defect Investigations and Recalls Division, and Grand Design RV.

To contact **Transport Canada**,

Website: [www.tc.gc.ca](http://www.tc.gc.ca)

Address: Transport Canada  
Defect Investigations & Recalls Division  
330 Sparks Street  
Ottawa ON K1A 0N5  
Canada

Toll-free in Canada: 1-800-333-0510

*If calling internationally,*

*or from the Gatineau-Ottawa area: 1-819-994-3328*

# Service & Warranty

## Dealer's Responsibilities

When you buy your new RV, at the time of purchase, your dealer is expected to:

1. **Deliver your RV in the best condition possible.**  
Your RV must pass the dealer's Pre-Delivery Inspection (PDI). This inspection tests all systems and components.
2. Provide an orientation, familiarizing you with your new RV and how to operate all systems and components.
3. Review with you, and explain the provisions of the *Limited Base Warranty* and *Limited Structural Warranty*.
4. Send your completed *Warranty Registration and New Vehicle PDI Check List* to Grand Design RV.  
***This form is required within 30 days of your delivery date to activate your warranty coverage.***
5. Ensure that you receive a complete Owner Information Package. Assist you with all component manufacturer warranty registrations (ie, locating the model and serial numbers of components as needed).
6. Explain how to obtain local and out-of-town service for your RV, and its (separately warranted) components, including repairs NOT under warranty.
7. Service all Grand Design RV products.



The Limited Base Warranty and Limited Structural Warranty are activated only after Grand Design RV receives the completed (signed and dated) warranty registration from your dealer.

## Owner's Responsibilities

As the owner, you are responsible for the regular care and proper maintenance of your RV. Proper maintenance will help avoid situations where the Limited Base Warranty and Limited Structural Warranty will not cover items due to neglect. You need to perform maintenance services in accordance with this manual and the corresponding manufacturer instructions for the components included in your RV.

As the owner, it is your responsibility and obligation to return the RV to an authorized dealer for any warranty repairs and service that may be required. Your dealer is responsible for proper service prior to delivery, and has a continued interest in your satisfaction. Therefore, we recommend warranty and maintenance services be performed by your Grand Design RV dealer.

As with your other personal belongings, it is important to protect yourself and others with insurance coverage. Your insurance agent can assist you in obtaining the appropriate insurance coverage for personal liability, theft, collision, property damage, etc.



Failure to contact Grand Design RV Customer Support, unauthorized or improper warranty repairs, or not returning requested original parts may result in loss of reimbursement and/or loss of warranty.

## Obtaining Warranty Service

### Warranty service must be obtained:

- WITHIN a reasonable time after the discovery of a defect, *and*
- BEFORE the applicable warranty period expires.

To help your dealer provide you the best level of service, please do the following:

### Call ahead

It is best to have your service performed several weeks before you plan to use your RV. Your dealer may need some time to get you in their schedule. Most service departments are busiest on Mondays, Fridays and before holidays.

### Be prepared

Keep your warranty and service history paperwork available. Past repairs and maintenance records may help the service technician diagnose a current issue.

### Make a list

Provide the dealer a prioritized list of all repairs needed. If you need your RV returned by a specific date, discuss this with the dealer's service management. A second appointment may be required to complete lower priority list items or if parts need to be ordered.

### While waiting

If possible, drop off your RV. Usually, customers cannot watch as repair work is performed. Insurance companies may even require that customers not be allowed in the service area.

### Inspect the work performed

Inspect all repairs thoroughly. Notify the dealer's service manager of any dissatisfaction right away.

- If you cannot immediately return your RV for repair, make an appointment to return as soon as possible.
- If a problem re-occurs after leaving the dealership, contact the dealer's service manager *and* Grand Design RV Customer Support, to quickly resolve the issue.



Please have the following available when you call:

1. Your name, location and phone number where you can be reached
2. Your RV's 17-digit VIN
3. Date of purchase
4. Contact information for the RV repair facility or dealer
5. Detailed description of the concern
6. If applicable, the component description, serial and model numbers



Promptly report any issue with an RV repair to the management where the work was done. All repair businesses require notification of problems within a specified time limit. Please familiarize yourself with the RV dealer or repair center's policies.

## Obtaining Emergency Warranty Repair

A roadside emergency can happen at any time, whether your RV is new or old. If you are traveling, using the following guidelines can help get you back on the road faster.

1. To find the nearest authorized repair center, use the **Dealer Locator** on our website [www.granddesignrv.com](http://www.granddesignrv.com).
2. If there is not an *authorized dealer* near your location, try the following to find a repair facility:
  - Ask the campground staff for referrals.
  - Check the local telephone yellow pages.
  - Contact your dealer, or
  - Grand Design RV Customer Support.

### **When you find an authorized dealer or repair facility:**

- a. Call the RV repair facility to discuss your situation and make an appointment. Ask how their billing will be handled. They may choose to bill Grand Design RV directly; otherwise, you are expected to pay them.
- b. Have the RV repair facility inspect your RV. Either they or you must call Grand Design RV Customer Support to discuss applicable warranty coverage prior to any repair work being performed.
- c. Grand Design RV Customer Support will issue an authorization number upon warranty repair approval and advise if any original parts must be returned.
- d. Only after the authorization number has been issued, may the repair center begin work on your RV.
- e. For reimbursement, either you or the RV repair facility must send a copy of your itemized repair bill and all requested return parts by UPS (regular ground, freight pre-paid) to Grand Design RV within 60-days of the completed repair date. To expedite processing your warranty claim, include your name, address, phone number, RV 17-digit VIN and authorization number. If returning parts, include a copy of your freight bill.



3. Inspect the completed repair work thoroughly. If you are not satisfied, communicate that to the RV repair facility management. Make sure you are satisfied with the repair before you pay or leave the premises.

### **Obtaining emergency repair assistance on a weekend or after business hours**

If an authorized Grand Design RV dealer is not located nearby, contact your selling dealer for assistance. If your dealer is closed, check with the campground staff or telephone yellow pages for an RV repair facility. Have the item repaired and contact Grand Design RV Customer Support immediately the following business day.

## Replacement Parts

Replacement warranty parts are distributed by authorized Grand Design RV dealers or service centers. Grand Design RV does not sell parts retail direct or to non-authorized dealers. If an original part is no longer available, Grand Design RV or your dealer will try to provide an appropriate substitute.

## Aftermarket Installations & Alterations

Aftermarket installations or alterations to the original equipment vehicle as distributed by Grand Design RV are not covered by the Limited Base and Structural Warranties. The special body company, assembler, equipment installer, or up-fitter is solely responsible for warranties on the body or equipment and any alterations (or any effect of the alterations) to any of the parts, components, systems, or assemblies installed by Grand Design RV. Grand Design RV is not responsible for the safety or quality of design features, materials, or workmanship of any alterations by such suppliers.

## Updating Your Contact Information

Federal law requires that we keep a record of Grand Design RV owners. Please help us keep your contact information up to date, so that we can promptly contact you in the event of a recall or customer notification letter.

We request that you please notify us in writing, of address and ownership changes, or if your RV is stolen, totaled or destroyed.

### **To update your contact information,**

Email: [customerservice@granddesignrv.com](mailto:customerservice@granddesignrv.com)

or Write: Grand Design RV  
11356 County Road 2  
Middlebury, IN 46540

*If you have any questions, please contact Grand Design RV Customer Support at (574) 825-9679.*

## **Grand Design RV ONE YEAR LIMITED BASE WARRANTY**

### **SUMMARY**

#### **What does this Warranty cover?**

Grand Design RV, LLC (“Warrantor”) provides this One (1) Year (“Warranty Period”) Limited Base Warranty [which begins to run from the earlier of (i) the date of purchase by the original retail consumer purchaser or (ii) when the recreational vehicle is put into service] against certain defects in materials and/or workmanship for the recreational vehicle manufactured by, and workmanship provided directly by, Warrantor arising under normal use and service to the ORIGINAL RETAIL CONSUMER PURCHASER for the Warranty Period of the recreational vehicle. This Warranty only covers material components and parts of the recreational vehicle actually manufactured by and made by Warrantor and labor provided directly by Warrantor but no parts not made or manufactured by Warrantor. In addition to the forgoing and the other limitations and restrictions set for in this limited warranty, this limited warranty only covers a recreational vehicle sold by an authorized warrantor dealer to the original retail customer or its assign (transfer) to another retail purchaser within the warranty period, but only if the warranty for the recreational vehicle is registered in the original vehicle owner’s name within the thirty (30) day start date period set forth above.

THIS WARRANTY CONSTITUTES THE EXCLUSIVE REMEDY FOR ALL DEFECTS OF MATERIAL AND WORKMANSHIP. THIS WARRANTY IS IN LIEU OF ANY AND ALL OTHER EXPRESSED OR IMPLIED WARRANTIES. THERE ARE NO OTHER EXPRESSED OR IMPLIED WARRANTIES BEYOND THOSE SET FORTH HEREIN. THERE ARE NO WARRANTIES WHICH EXTEND BEYOND THE DESCRIPTION ON THE FACE HEREOF. IN ADDITION TO THE EXCLUSIONS SET FORTH IN THIS LIMITED WARRANTY, THIS WARRANTY DOES NOT APPLY TO DAMAGE DUE TO NEGLIGENT USE, MISUSE, ABUSE OR ACCIDENT INVOLVING ANY PART AND/OR ALL OF THE RECREATIONAL VEHICLE, OR THE REPAIR OR ALTERATION OF SUCH RECREATIONAL VEHICLE. ANY REPAIR OR ALTERATION TO THE RECREATIONAL VEHICLE SPECIFICALLY VOIDS THIS WARRANTY. ANY COMMERCIAL USE, RENTAL, OR BUSINESS USE OF THE RECREATIONAL VEHICLE VOIDS THIS AND ALL OTHER WARRANTIES PROVIDED BY WARRANTOR.

The sole remedy for a breach of the warranty is as follows. Defective parts and workmanship will be replaced by the Warrantor, or the Warrantor’s authorized agent, provided that the following terms are met:

1. The Warrantor’s authorized agent must be notified of the covered defect within the warranty period and within Twenty (20) days of when the defect was discovered or should have been discovered by a reasonable person exercising reasonable care according to the terms of this Limited Warranty.
2. The person seeking the replacement of the defective part or labor must be the original retail consumer purchaser, or an assignment to another consumer purchaser within the Warranty Period. Any assignment does not extend the Warrant Period.

## Service & Warranty

3. The defective material or workmanship for which the warranty work and/or part is sought must be to the RECREATIONAL VEHICLE itself only.
4. The other terms and conditions of this Limited Warranty must be satisfied.

### **What types of things are excluded from the Warranty?**

This Warranty does not cover:

- a. Defects in any component parts or labor of the recreational vehicle which are not considered the RECREATIONAL VEHICLE or which were not manufactured by Warrantor;
- b. Defects in any items or labor which are covered by a separate warranty from the original manufacturer of any part that is used by Warrantor in the RECREATIONAL VEHICLE;
- c. Deterioration due to normal wear, tear, and exposure;
- d. Repairs or replacements made necessary by negligence, negligent use of, misuse of, abuse of, loading the unit beyond its gross weight limitations, accidents, acts of God, modifications or alterations in or to the RECREATIONAL VEHICLE by anyone, and failure to maintain or care for the RECREATIONAL VEHICLE, and any and all matters which were not within the control of the Warrantor;
- e. Neglect of the recreational vehicle or any part of it;
- f. Repairs or replacements made necessary by reason of a failure of the original retail consumer purchaser or others to follow ordinary maintenance procedures as recommended by the Warrantor or the manufacturer or dealer of the recreational vehicle;
- g. Any defect caused in-transit to or from a dealer or to or from the consumer or by the consumer or another;
- h. Any defects in work, labor, materials or parts not actually manufactured by, performed by or made by Warrantor;
  - i. Tires; Batteries; Optional Generators and certain Appliances & Electronic Entertainment Equipment which is warranted separately by the respective component manufacturer.
  - j. Recreational vehicles purchased anywhere other than from an authorized Warrantor dealer;
  - k. Alterations, modifications or changes to the original design and build of the recreational vehicle;
    - l. Vehicles used for rental, business or disaster relief purposes;
- m. Routine maintenance and adjustments;
- n. Vehicles registered and used outside the U.S. and Canada;
- o. Consequential/incidental expenses (damages) such as service calls, transportation, lodging, food, fuel, etc. NOTE: Some states do not allow the exclusion of incidental or consequential damages, so this exclusion may not apply to you;
- p. Fading, yellowing or aging of exterior materials due to UV or sunlight or weather exposure;
- q. Damage that has occurred as a result of misuse, abuse, neglect, or lack of maintenance;

- r. Damage caused by unregulated water pressure, tank over-fill or plumbing system modifications resulting in flooding of the vehicle;
- s. Damage caused by unprotected electrical hook-ups (home or campground), power surges, lightning, circuit overload or electrical system modifications;
- t. Damage caused by overloading or improper weight distribution;
- u. Damage caused by improper ventilation resulting in excessive condensation which results in water damage and/or mold or mildew;
- v. Damage, fading or deterioration caused by prolonged exposure to natural elements;
- w. Damage caused by infestation by insects or other animals;
- x. Damage caused by the tow vehicle hitch, equalizer, stabilizer, electrical or brake controller system;
- y. Damage caused by the environment or weather, including, but not limited to, flooding, high winds, acid rain, hail, lightning, high heat, extreme cold, etc.
- z. Damage caused by road surface conditions, applications of salt or de-icing chemicals, gravel/sand, ruts, holes, etc.;
- aa. Exterior paint or finish which is warranted independently by the paint manufacturer and/or independent applicator;
- ab. DEFACING: scratches, dents, and rust on any surface of the RECREATIONAL VEHICLE; and
- ac. EXCESS weight on the RECREATIONAL VEHICLE.

## **WARRANTOR'S OBLIGATIONS - HOW TO GET WARRANTY SERVICES**

### **How Do You Get Service?**

In no event shall repair or replacement for a defect be covered under this Warranty unless the repair or replacement occurs at Warrantor's facilities, or Warrantor's designated repair shop or dealer. Upon discovery of any defect covered by this Warranty, you must notify the authorized dealer from whom you purchased the recreational vehicle. Following notification, the recreational vehicle must be taken to the authorized dealer from whom you purchased it for inspection or another authorized dealer, if authorized by Warrantor, or authorized repair shop as directed by Warrantor. Either that dealer or repair shop or Warrantor will undertake appropriate corrective repairs in instances where the defect is covered by this Warranty. Warrantor reserves the right to use or cause the use of alternative parts or components having substantially equal or greater quality.

Warrantor will remedy defects in materials and workmanship covered under this Limited Warranty under normal use and service caused by Warrantor in the RECREATIONAL VEHICLE ONLY of the recreational vehicle. Warranty performance can only be obtained at Warrantor's authorized dealers and service representatives. All costs incurred in transporting this recreational vehicle for warranty service shall be borne by purchaser unless otherwise approved in advance by Warrantor.

### **What are purchaser's obligations?**

The purchaser shall give notice to the Warrantor's agent or dealer within Twenty (20) days after it is or should have been discovered, and any action to enforce it shall be commenced not more than three (3) months thereafter; otherwise the Purchaser will have waived any such defect and claim, and any and all damages arising as a result thereof. The purchaser must perform reasonable and necessary maintenance upon the recreational vehicle and use the recreational vehicle in accordance with the manufacturer of the recreational vehicles and Warrantor's directions and recommendations. Among the other requirements under this Warranty, the Purchaser must also:

- Maintain the recreational vehicle in accordance with the maintenance requirements contained in the Owner's Manual;
- Make minor adjustments including (but limited to) doors, drawers, latches, regulators, controls, mechanisms, etc. after 90 days of ownership;
- Maintain all exterior seals and sealant, which must be inspected every 6 months to assure there are no gaps or voids, and correcting as necessary; and
- Return their vehicle to an authorized dealer for repairs.

If you believe that you have a claim under this Warranty, locate and contact your nearest authorized Warrantor dealer to schedule an appointment. Be prepared to provide your vehicle serial number (VIN), date of purchase, and a description of the issue or concern. If you cannot locate a dealer, please go to the Warrantor's web site or contact Warrantor directly for immediate assistance.

### **What are the Dealer's Responsibilities?**

- Perform a walk-through to assure that the customer understands the operation, use and safety requirements of the vehicle;
- Review vehicle warranties, operating manuals and instruction guides; and
- Inform the customer on how to obtain service, locally or while in transit;

**Warrantor is not responsible or liable for any failures, breaches, negligence, inattention or problems on the part of the Dealer.**

### **What events discharge Warrantor from the obligations under this Warranty?**

Misuse or negligent use, abuse, or accident, neglect, unauthorized alteration, failure to provide reasonable and necessary maintenance including reasonable periodic inspections of the recreational vehicle and/or use of the recreational vehicle for rental, business or commercial use or any other use other than to use the recreational vehicle only for personal use, shall each discharge the Warrantor from any obligation under this Warranty. The recreational vehicle is designed for recreational and personal use.

## **What do I do to activate warranties of other manufacturers of component parts and goods?**

### **COMPONENT WARRANTIES**

As stated above, some components, accessories or equipment are not covered by this Base Limited Warranty. Examples include tires, batteries, optional generators, and some appliance & electronic entertainment equipment. However, those items may have coverage provided by the component manufacturer. These warranties are completely separate from this Limited Base Warranty, and in some cases may be longer and/or have specific coverage provisions and requirements. In order to activate these warranties you may have to complete registration forms, post cards or some other form of notification to the component manufacturer within a specific time period. These forms and documents will be located with the Owner's Materials provided with your new vehicle. You must complete and submit them to the respective manufacturer as quickly as possible, and within the time periods required by those warranties.

### **DISCLAIMER OF CONSEQUENTIAL, PUNITIVE AND INCIDENTAL DAMAGES**

#### **What other conditions or limitations apply to this Warranty?**

The original retail purchaser of the recreational vehicle and any person to whom the recreational vehicle is transferred or given or conveyed, and any person who is an intended or unintended user or beneficiary of this Limited Warranty, shall not be entitled to recover from Warrantor any consequential, punitive or incidental damages resulting from any defect in the recreational vehicle, or loss of use, time or revenues. This warranty also excludes costs of transportation to any authorized dealer or service representative or to the Warrantor to get warranty service, loss of use of the recreational vehicle, loss of time, loss of revenues, inconvenience, or other incidental or consequential damage and any punitive damages, with respect to business or property, whether as a result of breach of warranty, negligence, or otherwise.

Some states do not allow the exclusion or limitation or the exclusion may not apply to you.

TO THE EXTENT NOT EXCLUDED IN THIS LIMITED WARRANTY, THE IMPLIED WARRANTY OF MERCHANTABILITY, AN UNWRITTEN WARRANTY THAT THE PRODUCT IS FIT FOR ORDINARY USE, IS LIMITED TO THE WARRANTY PERIOD OF THIS WRITTEN WARRANTY, AND ANY OTHER IMPLIED WARRANTY ARISING BY OPERATION OF LAW ARE SPECIFICALLY LIMITED TO THE WARRANTY PERIOD OF THIS WRITTEN WARRANTY TO THE EXTENT NOT ACTUALLY EXCLUDED IN THIS LIMITED WARRANTY.

IF ANY MODEL OR SAMPLE IS SHOWN TO THE PURCHASER PRIOR TO THE PURCHASE OF THE RECREATIONAL VEHICLE, SUCH SAMPLE OR MODEL WAS MERELY TO ILLUSTRATE A GENERAL TYPE OF QUALITY AND NOT TO REPRESENT THAT THE RECREATIONAL VEHICLE WOULD NECESSARILY CONFORM TO A SAMPLE OR MODEL AND SHALL NOT BE DEEMED TO BE PART OF THE BASIS OF THE BARGAIN OR CREATE ANY EXPRESSED WARRANTIES OR AFFIRMATIONS OR PROMISES.

## **DISCLAIMER OF EXPRESSED AND IMPLIED WARRANTIES**

THE WARRANTOR EXPRESSLY DISCLAIMS ALL IMPLIED WARRANTIES OF MERCHANTABILITY AND FITNESS FOR A PARTICULAR PURPOSE AND ANY OTHER IMPLIED WARRANTIES.

THERE IS NO EXPRESS OR IMPLIED WARRANTY MADE BY WARRANTOR BEYOND THAT CONTAINED IN THE LIMITED WARRANTY ABOVE. THE ABOVE REFERENCED LIMITED WARRANTY IS IN LIEU OF ANY AND ALL OTHER WARRANTIES. TO ACTIVATE THE LIMITED WARRANTY, THE RECREATIONAL VEHICLE MUST BE REGISTERED WITHIN THIRTY (30) DAYS OF THE DATE OF PURCHASE; OTHERWISE, THIS LIMITED WARRANTY WILL NOT BE EFFECTIVE. NO PERSON HAS THE AUTHORITY TO ENLARGE, AMEND, OR MODIFY THIS WARRANTY.

Some states do not allow limitations on how long an implied warranty lasts, so the above limitations may not apply to you.

## **DESIGN CHANGES**

Warrantor reserves the right to change the design of its RECREATIONAL VEHICLE from time to time without notice and without obligation to make corresponding changes in its products previously manufactured.

## **ATTORNEYS FEES**

Any warranty claim asserted or brought in violation of this Limited Warranty, or any claim brought against WARRANTOR, directly or indirectly, under which the Purchaser or any other person or entity seeks to broaden the terms of the Limited Warranty or under which the Purchaser or any other person fails to successfully prevail on any issue or matter of any type or nature, shall entitle Warrantor to recover its costs, damages, and reasonable attorney's fees in connection with the same.

## **How Does State Law Relate to This Warranty?**

This Warranty gives you specific legal rights, and you may also have other rights which vary from state to state.

**By registering or having your recreational vehicle registered in your name, or by asserting a claim under this Limited Warranty, Purchaser (and all assigns) is agreeing on behalf of the purchaser and all assigns to be bound by the terms and conditions of this Limited Warranty.**



## **Grand Design RV THREE YEAR LIMITED STRUCTURAL WARRANTY**

### **SUMMARY**

#### **What does this Warranty cover?**

Grand Design RV, LLC (“Warrantor”) provides this Three (3) Year (“Warranty Period”) Limited Structural Warranty [which begins to run from the earlier of (i) the date of purchase by the original retail consumer purchaser or (ii) when the recreational vehicle is put into service] against certain defects in materials and/or workmanship for the structural components manufactured by, and workmanship provided directly by, Warrantor arising under normal use and service to the structural components (as defined below) for the above described recreational vehicle of Warrantors to the ORIGINAL RETAIL CONSUMER PURCHASER for the Warranty Period. This Warranty only covers material components and parts of the Structural Components actually manufactured by and made by Warrantor and labor provided directly by Warrantor. In addition to the forgoing and the other limitations and restrictions set for in this limited warranty, this limited warranty only covers a recreational vehicle sold to the original retail customer by an authorized warrantor dealer within the thirty (30) day start period set forth above. This Warranty is not assignable to any person or entity.

“Structural Components” consist of: materials and/or workmanship directly attributable to Warrantor, namely, the laminated fiberglass sidewall assembly, laminated fiberglass rear wall assembly, laminated fiberglass front wall (wrap), sidewall/end wall/front and rear wall frame assembly (wood and aluminum), roof assembly, floor assembly and frame assembly.

THIS WARRANTY CONSTITUTES THE EXCLUSIVE REMEDY FOR ALL DEFECTS OF MATERIAL AND WORKMANSHIP. THIS WARRANTY IS IN LIEU OF ANY AND ALL OTHER EXPRESSED OR IMPLIED WARRANTIES. THERE ARE NO OTHER EXPRESSED OR IMPLIED WARRANTIES BEYOND THOSE SET FORTH HEREIN. THERE ARE NO WARRANTIES WHICH EXTEND BEYOND THE DESCRIPTION ON THE FACE HEREOF. IN ADDITION TO THE EXCLUSIONS SET FORTH IN THIS LIMITED WARRANTY, THIS WARRANTY DOES NOT APPLY TO DAMAGE DUE TO NEGLIGENT USE, MISUSE, ABUSE OR ACCIDENT INVOLVING ANY PART AND/OR ALL OF THE STRUCTURAL COMPONENTS, OR THE REPAIR OR ALTERATION OF SUCH STRUCTURAL COMPONENTS. ANY REPAIR OR ALTERATION TO THE STRUCTURAL COMPONENTS SPECIFICALLY VOIDS THIS WARRANTY. ANY COMMERCIAL USE, RENTAL, OR BUSINESS USE OF THE RECREATIONAL VEHICLE VOIDS THIS AND ALL OTHER WARRANTIES PROVIDED BY WARRANTOR.

The sole remedy for a breach of the warranty is as follows. Defective parts and workmanship will be replaced by the Warrantor, or the Warrantor’s authorized agent, provided that the following terms are met:

1. The Warrantor’s authorized agent must be notified of the covered defect within the warranty period and within Twenty (20) days of when the defect was discovered or should have been discovered by a reasonable person exercising reasonable care according to the terms of this Limited Warranty.

## Service & Warranty

2. The person seeking the replacement of the defective part or labor must be the original retail consumer purchaser. An assignment of the recreational vehicle to another person voids this Limited Warranty.
3. The defective material or workmanship for which the warranty work and/or part is sought must be to the STRUCTURAL COMPONENTS only.
4. The other terms and conditions of this Limited Warranty must be satisfied.

What types of things are excluded from the Warranty?

This Warranty does not cover:

- a. Defects in any component parts or labor of the recreational vehicle which are not considered the STRUCTURAL COMPONENTS or which were not manufactured by Warrantor;
- b. Defects in any items or labor which are covered by a separate warranty from the original manufacturer of any part that is used by Warrantor in the STRUCTURAL COMPONENTS;
- c. Deterioration due to normal wear, tear, and exposure;
- d. Repairs or replacements made necessary by negligence, negligent use of, misuse of, abuse of, loading the unit beyond its gross weight limitations, accidents, acts of God, modifications or alterations in or to the STRUCTURAL COMPONENTS by anyone, and failure to maintain or care for the STRUCTURAL COMPONENTS, and any and all matters which were not within the control of the Warrantor;
- e. Neglect of the recreational vehicle or STRUCTURAL COMPONENTS;
- f. Repairs or replacements made necessary by reason of a failure of the original retail consumer purchaser or others to follow ordinary maintenance procedures as recommended by the Warrantor or the manufacturer or dealer of the Structural Components;
- g. Any defect caused in-transit to or from a dealer or to or from the consumer or by the consumer or another;
- h. Any defects in work, labor, materials or parts not actually manufactured by, performed by or made by Warrantor;
- i. Front and rear fiberglass caps and any other cosmetic fiberglass attachments;
- j. Sidewall metal (unless the root cause is the wall structure);
- k. Exterior roof material (EPDM rubber, TPO, etc.);
- l. Floor covering (carpet, linoleum, hardwood, tile, etc.);
- m. All sidewall, end wall, front and rear wall, roof and floor attachments;
- n. Delamination caused by water intrusion from lack of required exterior seal maintenance;
- o. Vehicles purchased anywhere other than from an authorized Warrantor dealer;
- p. Alterations, modifications or changes to the original design and build of the recreational vehicle;
- q. Vehicles used for rental, business or disaster relief purposes;
- r. Routine maintenance and adjustments;
- s. Vehicles registered and used outside the U.S. and Canada;

- t. Consequential/incidental expenses (damages) such as service calls, transportation, lodging, food, fuel, etc. NOTE: Some states do not allow the exclusion of incidental or consequential damages, so this exclusion may not apply to you;
- u. Fading, yellowing or aging of exterior materials due to UV or sunlight or weather exposure;
- v. Damage that has occurred as a result of misuse, abuse, neglect, or lack of maintenance;
- w. Damage caused by unregulated water pressure, tank over-fill or plumbing system modifications resulting in flooding of the vehicle;
- x. Damage caused by unprotected electrical hook-ups (home or campground), power surges, lightning, circuit overload or electrical system modifications;
- y. Damage caused by overloading or improper weight distribution;
- z. Damage caused by improper ventilation resulting in excessive condensation which results in water damage and/or mold or mildew;
- aa. Damage, fading or deterioration caused by prolonged exposure to natural elements;
- ab. Damage caused by infestation by insects or other animals;
- ac. Damage caused by the tow vehicle hitch, equalizer, stabilizer, electrical or brake controller system;
- ad. Damage caused by the environment or weather, including, but not limited to, flooding, high winds, acid rain, hail, lightning, high heat, extreme cold, etc.
- ae. Damage caused by road surface conditions (gravel/sand, ruts, potholes, etc.); applications of salt or de-icing chemicals resulting in rust.
- af. Exterior paint or finish which is warranted independently by the paint manufacturer and/or independent applicator;
- ag. Defacing: scratches, dents, and rust on any surface of the STRUCTURAL COMPONENTS; and
- ah. Excess weight on the STRUCTURAL COMPONENTS.

## **WARRANTOR'S OBLIGATIONS - HOW TO GET WARRANTY SERVICES**

### **How Do You Get Service?**

In no event shall repair or replacement for a defect be covered under this Warranty unless the repair or replacement occurs at Warrantor's facilities, or Warrantor's designated repair shop or dealer. Upon discovery of any defect covered by this Warranty, you must notify the authorized dealer from whom you purchased the recreational vehicle. You must always notify the Warrantor as well even if you contact the dealer from whom you purchased the recreational vehicle. Following notification, the recreational vehicle must be taken to the authorized dealer from whom you purchased it for inspection or another authorized dealer, if authorized by Warrantor, or authorized repair shop as directed by Warrantor. Either that dealer or repair shop or Warrantor will undertake appropriate corrective repairs in instances where the defect is covered by this Warranty. However, no work may be performed to the STRUCTURAL COMPONENTS without the prior authorization of the Warrantor. And, Warrantor reserves the right to use or cause the use of alternative parts or components having substantially equal or greater quality.

## Service & Warranty

Warrantor will remedy defects in materials and workmanship covered under this Limited Warranty under normal use and service caused by Warrantor in the STRUCTURAL COMPONENTS ONLY of the recreational vehicle. Warranty performance can only be obtained at Warrantor's authorized dealers and service representatives. All costs incurred in transporting this recreational vehicle for warranty service shall be borne by purchaser unless otherwise approved in advance by Warrantor.

### **What are purchaser's obligations?**

The purchaser shall give written notice to the Warrantor or an Authorized Dealer of any defect within Twenty (20) days after it is or should have been discovered, and any action to enforce it shall be commenced not more than three (3) months thereafter; otherwise the Purchaser will have waived any such defect and claim, and any and all damages arising as a result thereof. The purchaser must perform reasonable and necessary maintenance upon the recreational vehicle and STRUCTURAL COMPONENTS and use the recreational vehicle and STRUCTURAL COMPONENTS in accordance with the recreational vehicle manufacturer and Warrantor's directions and recommendations. Among the other requirements under this Warranty, the Purchaser must also:

- Maintain the recreational vehicle in accordance with the maintenance requirements contained in the Owner's Manual; and
- Maintain all exterior seals and sealant, which must be inspected every six (6) months to assure there are no gaps or voids, and all gaps and voids must be corrected as necessary. Documentation acceptable to Warrantor must be presented confirming completion of an annual sealant inspection by an authorized Warrantor dealer or authorized dealer repair shop for coverage consideration.

If you believe that you have a claim under this Warranty, locate and contact your nearest authorized Warrantor dealer to schedule an appointment. Be prepared to provide your vehicle serial number (VIN), date of purchase, and a description of the issue or concern. If you cannot locate a dealer, please go to the Warrantor's web site or contact Warrantor directly for immediate assistance.

### **What events discharge Warrantor from the obligations under this Warranty?**

Misuse or negligent use, abuse, or accident, neglect, unauthorized alteration, failure to provide reasonable and necessary maintenance including reasonable periodic inspections of the recreational vehicle and STRUCTURAL COMPONENTS and/or use of the recreational vehicle for rental, business or commercial use or any other use other than to use the recreational vehicle only for personal use, shall each discharge the Warrantor from any obligation under this Warranty. The Structural Components in the recreational vehicle are designed for recreational and personal use.

## **DISCLAIMER OF CONSEQUENTIAL, PUNITIVE AND INCIDENTAL DAMAGES**

### **What other conditions or limitations apply to this Warranty?**

The original retail purchaser of the recreational vehicle and any person to whom the recreational vehicle is transferred or given or conveyed, and any person who is an intended or unintended user or beneficiary of this Limited Warranty, shall not be entitled to recover from Warrantor any consequential, punitive or incidental damages resulting from any defect in the recreational vehicle, or loss of use, time or revenues. This warranty also excludes costs of transportation to any authorized dealer or service representative or to the Warrantor to get warranty service, loss of use of the recreational vehicle, loss of time, loss of revenues, inconvenience, or other incidental or consequential damage and any punitive damages, with respect to business or property, whether as a result of breach of warranty, negligence, or otherwise

Some states do not allow the exclusion or limitation or the exclusion may not apply to you.

TO THE EXTENT NOT EXCLUDED IN THIS LIMITED WARRANTY, THE IMPLIED WARRANTY OF MERCHANTABILITY, AN UNWRITTEN WARRANTY THAT THE PRODUCT IS FIT FOR ORDINARY USE, IS LIMITED TO THE WARRANTY PERIOD OF THIS WRITTEN WARRANTY, AND ANY OTHER IMPLIED WARRANTY ARISING BY OPERATION OF LAW ARE SPECIFICALLY LIMITED TO THE WARRANTY PERIOD OF THIS WRITTEN WARRANTY TO THE EXTENT NOT ACTUALLY EXCLUDED IN THIS LIMITED WARRANTY.

IF ANY MODEL OR SAMPLE IS SHOWN TO THE PURCHASER PRIOR TO THE PURCHASE OF THE RECREATIONAL VEHICLE/STRUCTURAL COMPONENTS, SUCH SAMPLE OR MODEL WAS MERELY TO ILLUSTRATE A GENERAL TYPE OF QUALITY AND NOT TO REPRESENT THAT THE RECREATIONAL VEHICLE/STRUCTURAL COMPONENTS WOULD NECESSARILY CONFORM TO A SAMPLE OR MODEL AND SHALL NOT BE DEEMED TO BE PART OF THE BASIS OF THE BARGAIN OR CREATE ANY EXPRESSED WARRANTIES OR AFFIRMATIONS OR PROMISES.

## **DISCLAIMER OF EXPRESSED AND IMPLIED WARRANTIES**

THE WARRANTOR EXPRESSLY DISCLAIMS ALL IMPLIED WARRANTIES OF MERCHANTABILITY AND FITNESS FOR A PARTICULAR PURPOSE AND ANY OTHER IMPLIED WARRANTIES.

THERE IS NO EXPRESS OR IMPLIED WARRANTY MADE BY WARRANTOR BEYOND THAT CONTAINED IN THE LIMITED WARRANTY ABOVE. THE ABOVE REFERENCED LIMITED WARRANTY IS IN LIEU OF ANY AND ALL OTHER WARRANTIES. TO ACTIVATE THE LIMITED WARRANTY, YOU MUST RETURN THE ATTACHED NOTICE TO WARRANTOR WITHIN THIRTY (30) DAYS OF THE DATE OF PURCHASE; OTHERWISE, THIS LIMITED WARRANTY WILL NOT BE EFFECTIVE. NO PERSON HAS THE AUTHORITY TO ENLARGE, AMEND, OR MODIFY THIS WARRANTY

Some states do not allow limitations on how long an implied warranty lasts, so the above limitations may not apply to you.

## **DESIGN CHANGES**

Warrantor reserves the right to change the design of its STRUCTURAL COMPONENTS from time to time without notice and without obligation to make corresponding changes in its products previously manufactured.

## **ATTORNEYS FEES**

Any warranty claim asserted or brought in violation of this Limited Warranty, or any claim brought against WARRANTOR, directly or indirectly, under which the Purchaser or any other person or entity seeks to broaden the terms of the Limited Warranty or under which the Purchaser or any other person fails to successfully prevail on any issue or matter of any type or nature, shall entitle Warrantor to recover its costs, damages, and reasonable attorney's fees in connection with the same.

### **How Does State Law Relate to This Warranty?**

This Warranty gives you specific legal rights, and you may also have other rights which vary from state to state

### **What to do if a separately manufactured part is defective?**

Our warranty does not cover defects in separately manufactured products which are not produced or manufactured directly by Warrantor. These products may be warranted by their individual manufacturers. To the extent that such products installed in your recreational vehicle or STRUCTURAL COMPONENTS are covered by warranties from those manufacturers, the written warranties by the suppliers of those products may be provided with each new recreational vehicle for the convenience and clarification of the original retail consumer purchaser. If you have trouble locating the manufacturer supplying these warranties, your dealer will be glad to assist you. However, we have no responsibility or control over the outcome of warranty claims against these manufacturers.

### **How Does State Law Relate to This Warranty?**

This Warranty gives you specific legal rights, and you may also have other rights which vary from state to state.

**By registering, or having your recreational vehicle registered in your name, or by asserting a claim under this Limited Warranty, Purchaser (and all assigns) is agreeing on behalf of Purchaser and all assigns to be bound by the terms and conditions of this Limited Warranty.**

This page is intentionally blank.

## Component Supplier Contact Information

All component suppliers listed are correct at the time of printing. Grand Design RV may change components at their discretion. Please contact GDRV Customer Support with any questions.

Component	Brand	Supplier Website	Phone Number
Air Conditioner	RVP / Coleman	<a href="http://www.airxcel.com">www.airxcel.com</a>	(316) 832-3400
Awning(s)	Dometic	<a href="http://www.dometic.com">www.dometic.com</a>	(800) 544-4881
Axle	Dexter Axle	<a href="http://www.dexteraxle.com">www.dexteraxle.com</a>	(574) 295-7888
Baggage Doors	Lippert Components	<a href="http://www.lci1.com">www.lci1.com</a>	(574) 537-8900
Converter	WFCO	<a href="http://www.wfcoelectronics.com">www.wfcoelectronics.com</a>	(877) 294-8997
Cooktop (Outside)	Suburban	<a href="http://www.airxcel.com">www.airxcel.com</a>	(316) 832-3400
Entry Door	Lippert Components	<a href="http://www.lci1.com">www.lci1.com</a>	(574) 537-8900
Entry Steps	Lippert Components	<a href="http://www.lci1.com">www.lci1.com</a>	(574) 537-8900
Fireplace	Titan Flame	<a href="http://www.davecarter.com">www.davecarter.com</a>	(574) 642-0627
Fireplace * <i>150 Series, TT</i>	Everlight	<a href="http://ww.patrickind.com/brands/gustafson-lighting/">ww.patrickind.com/brands/gustafson-lighting/</a>	(574) 522-0871
Frame	Lippert Components	<a href="http://www.lci1.com">www.lci1.com</a>	(574) 537-8900
Furnace	Suburban	<a href="http://www.airxcel.com">www.airxcel.com</a>	(316) 832-3400
Graphics	BGS	<a href="http://www.burlingtongraphics.com">www.burlingtongraphics.com</a>	(262) 554-8808
Leveling System	Lippert Components	<a href="http://www.lci1.com">www.lci1.com</a>	(574) 537-8900
Load Center	WFCO	<a href="http://www.wfcoelectronics.com">www.wfcoelectronics.com</a>	(877) 294-8997
Microwave	Furrion	<a href="http://www.furrion.com">www.furrion.com</a>	(888) 354-5792
Microwave	High Pointe	<a href="http://www.collinssupport.com">www.collinssupport.com</a>	(574) 848-1118
Range Hood	Furrion	<a href="http://www.furrion.com">www.furrion.com</a>	(888) 354-5792
Range With Oven	Furrion	<a href="http://www.furrion.com">www.furrion.com</a>	(888) 354-5792
Refrigerator	Dometic	<a href="http://www.dometic.com">www.dometic.com</a>	(800) 544-4881
Refrigerator	Pummel Drive	<a href="http://www.midwestsales.org">www.midwestsales.org</a>	(800) 772-7262
Roof Membrane	Alpha Systems	<a href="http://www.alphasystemsinc.com">www.alphasystemsinc.com</a>	(574) 295-5206
Slideouts	Lippert Components	<a href="http://www.lci1.com">www.lci1.com</a>	(574) 537-8900
Slide Floor	Huber	<a href="http://www.huberwood.com">www.huberwood.com</a>	(800) 933-9220
Sofas	Lippert Components	<a href="http://www.lci1.com">www.lci1.com</a>	(574) 537-8900
Stereo	Furrion	<a href="http://www.furrion.com">www.furrion.com</a>	(888) 354-5792
Suspension System	Dexter Axle	<a href="http://www.dexteraxle.com">www.dexteraxle.com</a>	(574) 295-7888
Televisions	TCL	<a href="http://www.tclusa.com">www.tclusa.com</a>	(877) 300-8837
Tires	Westlake	<a href="http://www.lionsheadtireandwheel.com">www.lionsheadtireandwheel.com</a>	(574) 533-6169
Toilet	Thetford	<a href="http://www.thetford.com">www.thetford.com</a>	(800) 543-1219
TV Antenna	King	<a href="http://www.kingconnect.com">www.kingconnect.com</a>	(303) 772-9591
Water Heater	Atwood	<a href="http://www.dometic.com">www.dometic.com</a>	(800) 544-4881
Water Pump	Shurflo	<a href="http://www.shurflo.com">www.shurflo.com</a>	(574) 537-8900
Windows	Lippert Components	<a href="http://www.lci1.com">www.lci1.com</a>	(574) 537-8900



## Component Manufacturer Warranty Information

Each manufacturer provides their own warranty for the components on your Reflection FW. This warranty information is current at the time printing, but is subject to change at any time per the manufacturer. Details can be found on the company websites listed or by contacting them directly. See **previous page**, *Component Supplier Contact Information*.

Component	Brand	Manufacturer Warranty
Air Conditioner	RVP / Coleman	Two year parts and service warranty. Original owner only.
Awning(s)	Dometic	One year parts and service warranty. Original owner only.
Axle	Dexter Axle	Five year limited warranty.
Baggage Doors	Lippert Components	Full one year warranty from date of purchase. Original owner only.
Converter	WFCO	Two year limited warranty.
Cooktop (Outside)	Suburban	Two year limited warranty.
Entry Door	Lippert Components	Full one year warranty from date of purchase. Original owner only.
Entry Steps	Lippert Components	Full one year warranty from date of purchase. Original owner only.
Fireplace	Dave Carter & Assoc.	One year limited warranty.
Fireplace * 150 Series, TT	Everlight	One year limited warranty from date of purchase.
Frame	Lippert Components	Full one year warranty from date of purchase. Original owner only.
Furnace	Suburban	Two year limited warranty.
Graphics	BGS	Five year limited warranty.
Leveling System	Lippert Components	Full one year warranty from date of purchase. Original owner only.
Load Center	WFCO	Two year limited warranty.
Microwave	Furrion	One year limited warranty.
Microwave	High Pointe	One year limited warranty.
Range Hood	Furrion	One year limited warranty.
Range With Oven	Furrion	One year limited warranty.
Refrigerator	Dometic	Two year parts and service warranty. Original owner only.
Refrigerator	Pummel Drive	One year limited warranty.
Roof Membrane	Alpha Systems	Twelve year limited warranty.
Slideouts	Lippert Components	Full one year warranty from date of purchase. Original owner only.
Slide Floor	Huber	25 years, not to exceed OEM warranty on finished product.
Sofas	Lippert Components	Full one year warranty from date of purchase. Original owner only.
Stereo	Furrion	One year limited warranty.
Suspension System	Dexter Axle	Five year limited warranty.
Televisions	TCL	One year limited warranty.
Tires	Westlake	No fault twelve month warranty from date of purchase. Five year warranty from tire manufacture date.
Toilet	Thetford	One year limited warranty.
TV Antenna	King	One year limited warranty.
Water Heater	Atwood	Two year limited warranty from date of purchase. Original owner only.
Water Pump	Shurflo	One year limited warranty.
Windows	Lippert Components	Two year limited warranty from date of purchase.

This page is intentionally blank.

## Occupant Safety

Your Reflection Fifth Wheel is designed with safety as the top priority. This RV meets or exceeds the safety standards and applicable codes in effect at the time it is built. All required safety items are carefully installed to protect you and the occupants of your RV.

### Family Safety Plan

Develop a *Family Safety Plan* to use in case of an emergency or severe weather condition. Practice it with your entire family, especially children.

- Before camping, please review and understand the locations of all doors, emergency exit windows, and safety equipment inside your RV.
- Teach everyone what the RV safety alarm signals mean and how to be prepared to leave the RV, by themselves if necessary.
- Draw a floor plan of your RV and find two ways to exit. There should be at least one way to get out of your RV without opening the door.
- Teach everyone how to *check doors* (and to not open them if they are hot). Also teach everyone to *stay low* to try to avoid breathing smoke, fumes or gases.
- Decide on a meeting place a safe distance from your RV. Make sure everyone understands to gather and wait there, in case family members are separated from one another in an emergency.
- Make sure everyone knows where to go to call the fire department or 911 from outside the RV.
- Conduct safety drills at least every six months. Make sure everyone, guests included, knows how to evacuate the RV safely.
- Practice exiting the RV blindfolded; in a real fire situation, thick black smoke can make it impossible to see.
- Ask an out-of-state relative or friend to serve as your *family contact*. Make sure everyone knows the contact person's name, address, phone number and email.

*For additional safety precautions, Consult your local fire dept.*

#### **WARNING**

During severe weather conditions, move indoors to a place of safety or shelter as directed by campground or appropriate authorities. Avoid trees or power lines that could fall on your vehicle. The safest place during severe weather conditions is inside a basement or storm shelter, not an RV or tow vehicle.

#### **WARNING**

Be aware of the **Heat Index** if camping during hot weather. Keep hydrated, and try to stay indoors in an air conditioned area during a high heat index warning.

## Pet Safety

Pets may not be allowed into shelters for health and space reasons. Prepare an emergency plan for pets that includes at least a 3-day supply of dry food and a large container of water. The survival of a beloved pet often depends on the plans its owner has made in advance.

## Emergency Weather Planning

Severe weather is one of the more serious conditions to take into account when camping. Weather can change with little or even no warning. Thunderstorms, hail, flooding, hurricanes, tornadoes, earthquakes, etc. can threaten your safety and damage your tow vehicle or RV.

Local radio and TV stations normally broadcast weather conditions and warnings as they occur. Research other methods of learning about severe weather conditions and how to deal with them. You may want to consider investing in a weather radio. Weather radios offer 24 hour-a-day VHF broadcasts of weather observations and forecasts directly from the US National Weather Service (NWS).

The frequencies used by the US National Oceanic and Atmospheric Administration (NOAA) weather radio stations are 162.400, 162.425, 162.450, 162.475, 162.500, 162.525, or 162.550 megahertz or visit their website [www.noaa.gov](http://www.noaa.gov).

### Repairing severe weather damage

If your tow vehicle or RV is damaged due to severe weather, you will most likely need repair work. Call your insurance company as soon as you can to report your claim.



*Please familiarize yourself with the following weather terms:*

**Warning** - indicates that a particular weather hazard is either imminent or has been reported.

Move to a safe location immediately. Take action to protect life and property. The type of hazard is named in the type of warning (tornado warning, blizzard warning, etc.).

**Watch** - indicates that a particular weather hazard is possible and that conditions are favorable for its occurrence.

A watch is a time for preparation, planning, and increased awareness. Stay alert for changing weather, listen for further information and think about what to do if the danger materializes.

## Fire Safety

Please AVOID the three most common Fire Safety issues: smoking in bed, leaving children unattended and use of flammable cleaning fluids/solvents.

- **In a fire emergency, EVACUATE the RV first, then call 911 from a safe location.**
- **In a fire emergency,** execute your *Family Safety Plan*.
- Make sure everyone knows to **Stop, Drop & Roll** if their clothes catch fire.
  - **Stop** in place, do not run.
  - **Drop** to the ground.
  - **Roll** back and forth, with hands shielding face from the fire.
- Supervise children around any open flame, especially grills, and campfires.
- Learn and teach safe fire practices. Build campfires away from nearby trees or bushes.
- Maintain at least a three-foot *clear area* around grills, campfires and tents, that is free of leaves, dry grass, pine needles, etc.
- ALWAYS have a way to quickly and completely extinguish a campfire ready *in advance*. NEVER leave a fire burning unattended, even a cigarette.
- Teach family members how to use the fire extinguisher and replace it as recommended.
- DO NOT store combustible materials in closed areas or near a heat source.
- DO NOT use water to put out a grease fire. Water can spread some types of fire and create an electrocution hazard during an electrical fire.
- ALWAYS call the Fire Department, No matter how small the fire.

*More information on firefighting can be found at the National Fire Protection Association website ([www.nfpa.org](http://www.nfpa.org)).*



If you feel that a fire was caused by product failure, call Grand Design RV Customer Service at (574) 825-8000 immediately for approval BEFORE you clean any debris, enter, move or repair your RV. Failure to notify Grand Design RV may result in loss of coverage.

## Fire Extinguisher

Safe escape is the most important part of a *fire response plan*. Fire can spread very fast. Your number one priority **MUST** be to get all occupants out safely.

A dry chemical, Class B /Class C type fire extinguisher is located near the entry door of your RV. The portable fire extinguisher can be used to put out small fires or contain one until the fire department arrives. Portable extinguishers do have limitations.

***Household fire extinguishers are classified into four types by Underwriters Laboratories (UL):***

Rating	Intended Use
Type A	For use on fires involving combustible materials such as wood, cloth and paper.
Type B	For use on flammable liquid fires, including kitchen grease. <u>Never</u> use water on this type of fire.
Type C	For use on fires involving energized electrical equipment.
Type ABC	Works on all three types of fires listed above.

### Operation

When you use the fire extinguisher, **ALWAYS** keep your back to a clear exit for an easy escape. Leave immediately if the fire cannot be controlled or the room fills with smoke.

There are different types and sizes of fire extinguishers, but for the most part, all of them work the same.

**To operate a fire extinguisher, remember the word: P.A.S.S.**

**P**ull the pin. Hold the extinguisher with the nozzle pointing away from you, and release the locking mechanism.

**A**im low. Point the extinguisher at the base of the fire.

**S**queeze the lever slowly and evenly.

**S**weep the nozzle from side-to-side until the fire is out.

### CAUTION

Avoid inhaling the dry chemical agent in the fire extinguisher. It is not toxic but may cause skin irritation. In case of contact, flush the affected area with clean, cool water. If irritations persists, contact a physician immediately.

## Disposal

Please check the local laws BEFORE disposing of your used (non-refillable) dry chemical fire extinguisher. Contact your local fire, sanitation or environmental protection department for rules on disposal.

## Emergency Egress Window

The *Emergency Egress Window (or exit window)* is your secondary exit, if the RV's entrance door becomes blocked or unavailable. All egress windows are marked with an *EXIT* label and have red handles or levers. Depending upon the window type, an egress window may be a large section or an entire window. Learn and practice how to open and operate the egress window to be prepared for an emergency:

- When pulling into your campsite, make sure the egress windows are not blocked by trees or other obstacles.
- Also check that below each egress window the ground is solid and the escape path is clear.
- Review the locations and operational instructions on the egress window label with all people staying in the RV.
- Plan escape routes from the front and rear of the RV.
- Decide who will exit through the emergency escape windows first, and in what position.
- Place a blanket or heavy coat over the window frame to cushion the exit.
- If there is a fire, the last person to exit the RV should be prepared to assist those in front.
- Arrange for a meeting place safely away from the RV.

## Maintenance

Occasionally open the windows to prevent the seals from sticking. The egress window must be locked during transit.

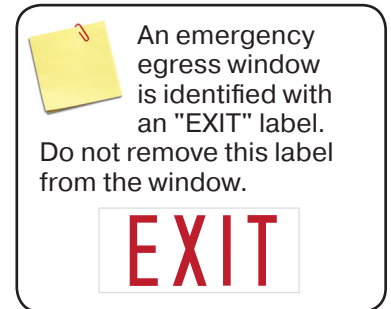



Smoke Alarm

**! WARNING**

Test Smoke Alarm operation after the RV has been in storage, before each trip and at least once per week during use.

**! WARNING**

Never use an open flame from a match or lighter to test the smoke alarm; you may accidentally ignite and set fire to the smoke alarm and your RV. If the smoke alarm does not test properly, replace it immediately.



During testing, you will hear a loud, repeating horn pattern and the red LED will flash rapidly on the smoke alarm.

## Smoke Alarm

The smoke alarm is located on the ceiling in the main living area of your RV. It is intended to help reduce injury or loss of life in a fire. Proper use can give you time to escape, but they are not foolproof. Smoke alarms only sound when smoke reaches them.

- Smoke alarms **MUST** be properly located, installed, and maintained.
- **Individuals with hearing loss or certain medical problems should consider using warning devices that provide both audible and visual signals**

### Operation

Check that a 9-volt battery is correctly connected. When the battery is supplying power, the red LED will flash. If smoke is detected by the sensor, a loud alarm will sound until the air is cleared.

### If the smoke alarm sounds

During an alarm, you will hear a loud, repeating horn pattern and the red LED will flash rapidly.

- The alarm warns you of a potentially dangerous situation that requires your immediate attention.
- **Never ignore any alarm.** Ignoring the alarm may result in injury or death.
- **EVACUATE** the RV first, *then*
- Call 911 from a safe location.

### How to test

It is important to test the smoke alarm at least once every week to make sure it is working properly. Stand at arm's length from the alarm when testing. The alarm horn is loud and may be harmful to your hearing.

1. Press and hold the **TEST** button on the smoke alarm cover until the alarm sounds (the smoke alarm may continue to alarm for a few seconds after you release the button).
2. If it does not alarm, make sure the smoke alarm is receiving power and test it again.
3. If it still does not alarm, replace it immediately.



## Battery

The smoke alarm will not function if the battery is missing, disconnected, dead, the wrong type of battery is used or the battery is installed incorrectly. When the 9-volt battery becomes weak, the smoke alarm will "chirp" (the low battery warning). If the low battery warning sounds, the battery **MUST** be replaced. Never disconnect the battery to silence the smoke alarm.

## Maintenance

Clean the smoke alarm at least once a month by gently vacuuming the outside cover. Do not paint over the smoke alarm. Paint may clog the openings to the sensing chambers and prevent it from operating properly.

## Carbon Monoxide (CO)

Carbon monoxide (CO) is an insidious poison. It is a colorless, odorless and tasteless gas. It can endanger lives even at low levels of concentration. Many cases of reported carbon monoxide poisoning indicate while victims are aware they are not well, they become so disoriented they are unable to save themselves by either exiting or calling for assistance. Young children and household pets may be the first affected.

CO gas is produced when any type of fuel is incompletely burned. Potential sources of CO in and around your RV can include gas or diesel engine exhaust, portable space heaters, gas stoves and ovens, furnaces, defective engine exhaust systems, portable grills, other nearby RVs, portable generators, generator exhaust, and other propane-powered appliances.

### The following symptoms may be related to CO POISONING:

It is important to discuss these symptoms with ALL household members and RV guests:

- **Mild exposure:** Headaches, running nose, sore or watery eyes, often described as *flu-like* symptoms.
- **Medium exposure:** Dizziness, drowsiness, vomiting.
- **Extreme exposure:** Unconsciousness, brain damage and death.

### **WARNING**

Actuation of the carbon monoxide (CO) alarm may indicate the presence of carbon monoxide (CO) or propane gases which can **KILL YOU**.

### **WARNING**

If you are in an RV with either a nearby tow vehicle engine or the generator running there is a potential for exhaust fumes to filter back into the RV.

The best protection against carbon monoxide entry into the RV is a properly maintained ventilation system and an active carbon monoxide detector. To allow for proper operation of the ventilation system, keep the ventilation inlet grill(s) clear of snow, leaves or other obstructions.



Carbon Monoxide (CO) Alarm

### **WARNING**

Test Carbon Monoxide Alarm operation after the RV has been in storage, before each trip and at least once per week during use.

### **WARNING**

If the CO alarm is not maintained and functioning properly according to OEM supplied instructions, you will not be warned if carbon monoxide is present in the air. Death or serious illness could result from asphyxiation if carbon monoxide is present.

## Carbon Monoxide Alarm

The CO alarm will sound if Carbon Monoxide (CO) in the air reaches dangerous levels. If you hear this alarm, evacuate the RV immediately and stay outside in *fresh air* until the CO alarm ceases.

The CO alarm is designed to be loud enough to wake up a sleeping person in an emergency. Prolonged exposure to the CO alarm at close distance may be harmful to your hearing. Individuals with hearing loss or certain medical problems, should consider using warning devices that provide both audible and visual signals.

### What you should do if the alarm sounds

1. **MOVE to fresh air immediately.**  
Go outside or to an open door/window, *then* execute your family safety plan.
2. DO NOT re-enter your RV.
3. If you are unable to exit, DO NOT move away from the open door/window until:
  - Emergency service responders have arrived,
  - Premises have been aired out, and
  - The CO alarm returns to its normal condition.
4. If your CO alarm reactivates within a 24-hour period:
  - Repeat steps 1-2.
  - Schedule an inspection by a *qualified appliance technician*, to check all fuel burning appliances are operating properly, and investigate for sources of carbon monoxide.
  - If problems are identified during this inspection, have the equipment serviced immediately.
5. Note any combustion equipment not inspected by the technician. For more information about CO safety and this equipment, consult the component manufacturer manual, or contact the manufacturer directly.
6. A motor vehicle or generator engine operating nearby is a possible source of CO inside your RV.

*A CO alarm is NOT A SUBSTITUTE for other combustible gas, fire or smoke alarms.*

## Batteries

The CO alarm will not function if the batteries are the wrong type, missing, disconnected, dead, or installed incorrectly. When the batteries become weak, the CO alarm will *beep* (the low battery warning). NEVER disconnect the batteries to silence the CO alarm. If the low battery warning sounds, the batteries MUST be replaced.

## Testing the CO alarm

Press and hold the test/reset button on the front of the CO alarm for several seconds. If the CO alarm does not test properly, replace it immediately.

## Maintenance

The CO alarm is pre-calibrated at the OEM factory and requires no maintenance other than to clean the outside casing occasionally with a cloth. Ensure that the holes on the front of the CO alarm are not blocked with dirt and dust.

- **DO NOT use cleaning agents, bleach or polish.**

## Propane Gas Alarm

A propane leak detection device is installed for your safety, because your new RV contains a *propane gas system* and *propane appliances*. Propane gas is heavier than air. During a leak, propane flows toward and collects in low areas. For this reason, the propane alarm is located near the floor of the RV. When the LED on the front glows green, the alarm is active.

- **Individuals with hearing loss or certain medical problems should consider using warning devices that provide both audible and visual signals**

The sensor may also detect other combustible fumes or vapors including; acetone, alcohol, butane and gasoline. These chemicals can be found in common items such as deodorant, cologne, perfume, wine, liquor, adhesive, lacquer, kerosene, most cleaning agents and the propellants of aerosol cans.

High temperatures can activate glue and adhesive vapors. If your RV is closed on a hot day, the chemicals used in its construction may be detected, even months after the vehicle was built.

See **Pages 43-46: Indoor Air Quality, Chemical Sensitivity & Outgassing, and Formaldehyde.**



Propane Gas Alarm

### **WARNING**

- Activation of this device indicates the presence of LP gas, which can cause an explosion and/or fire. This normally indicates a leak in the LP gas piping or an LP gas appliance.
- If the information in the manufacturer manual is not followed exactly, a fire or explosion may result, causing property damage, personal injury or loss of life.

### **WARNING**

- When the alarm is first turned on, it cannot detect propane or sound a warning for two minutes.
- The propane leak alarm is not a smoke or fire alarm.
- The alarm will only indicate the presence of propane gas at the sensor.
- Explosive gas may be present in other areas.



This label is found loose in your Owner Information Package. Please read and place as directed.

**PEEL OFF AND PLACE THIS LABEL NEAR THE SOURCE OF FRESH AIR WHERE YOU WANT TO GATHER AFTER AN ALARM. WRITE IN YOUR EMERGENCY SERVICES AND APPLIANCE TELEPHONE NUMBERS.**

**PROCEDURES TO TAKE DURING AN ALARM**

**⚠ WARNING:** Actuation of your CO alarm indicates the presence of carbon monoxide (CO) which can KILL YOU. If the alarm sounds; **1)** Operate the reset/silence button; **2)** Call your emergency services (Phone Number \_\_\_\_\_) (fire department or 911); **3)** Immediately move to fresh air - outdoors or by an open door/window. Do a head count to check that all persons are accounted for. Do not reenter the premises nor move away from the open door/window until the emergency responders have arrived, the premises have been aired out, and your alarm remains in its normal operation. **4)** After following steps 1-3, if your alarm reactivates within a 24 hour period, repeat steps 1-3 and call a qualified appliance technician. (Phone Number \_\_\_\_\_) to investigate for sources of CO from fuel burning equipment and appliances, and inspect for proper operation of this equipment. If problems are identified during this inspection have the equipment serviced immediately. Note any combustion equipment not inspected by the technician and consult the manufacturer's instructions, or contact the manufacturer directly, for more information about CO safety and this equipment. Make sure that the motor vehicles are not, and have not been, operating in an attached garage or adjacent to the residence.

MTI Form No. WL10981



**WARNING**

Test Propane Gas Alarm operation after the RV has been in storage, before each trip and at least once per week during use.

## Propane Gas Alarm, Continued

### If the alarm sounds

1. EVACUATE all persons from the RV. Open all windows and roof vents, *then* Execute your Family Safety Plan.
2. Shut OFF the gas supply at the LP tank valve.
  - Shut OFF all propane gas appliances (i.e., stove, water heater, furnace, etc.)
3. DO NOT touch any electrical switch; *and*
  - DO NOT use phones or electronic devices in the RV.

### DO NOT re-enter the RV until the problem is corrected.

4. DO NOT start any vehicle engine or generator.
5. Contact nearest qualified service technician or gas supplier for repairs.

*If you cannot reach a qualified service technician or gas supplier, Contact the nearest fire department.*

6. **An LP leak may be present** if the propane alarm continues to sound at regular intervals.
  - DO NOT run on gas supply until the leak is repaired.

*Contact your dealer or propane gas service to have the problem corrected BEFORE using the propane system.*

### Testing the propane gas alarm

The propane alarm should be tested after each storage period, before each trip, and at least once per week while camping.

- Test the propane alarm *at least* once per week.
  - If the propane alarm does not test properly, replace it immediately.
1. Press *TEST* button until alarm sounds; then release.
  2. The detector will sound twice.
  3. The LED will turn **red**, *then* after 8 seconds, turn **green** again, indicating normal operation.

### Battery or converter power source

The propane gas alarm runs on a small amount of 12-volt DC from the converter or auxiliary battery. This slight current draw can still drain your auxiliary battery during an extended storage period. The Low Voltage Warning will sound if the charge drops below 8 volts. **At lower voltage the alarm will no longer detect gas or provide protection against dangerous levels of LP.**

## Indoor Air Quality

### To maintain indoor air quality:

- **Allow your RV proper ventilation.**
- **Keep the interior clean.**
- **Avoid harmful air pollutants.**

Common air pollution sources include molds, pollen, pet dander, cigarette smoke, household cleaners and carbon monoxide from burning propane, charcoal or other fuels.

- *Proper ventilation* carries air pollutants outside, and dilutes emissions from indoor sources with fresh air from the outdoors.
- *Poor ventilation* may increase pollutant levels inside your RV. High temperature and humidity levels can also increase the concentration of some indoor air pollutants.
- The people most at risk for reactions to poor air quality include children, the elderly, and persons with: asthma, allergies, heart disease, or chronic lung diseases such as bronchitis and emphysema.

### To improve your air quality:

- Breathe fresh air by opening windows
- Spend as much time as you can outside in fresh air.
- Control mold:
  - Clean the bathroom and kitchen often.
  - Fix any water leaks.
  - Close windows and run your air conditioner (AC) or your dehumidifier.
  - Clean any mold you see or smell with a solution of 1 cup (or less) of bleach mixed with 1 gallon of water.
  - NEVER mix bleach with ammonia.
- Clean the interior often to get rid of dust and pet fur which can irritate your nose and throat.
- DO NOT use bug spray inside your trailer.
- DO NOT smoke inside your RV. In addition to causing damage to your RV, tobacco smoke releases formaldehyde and other air pollutants.

## Indoor Air Quality Continued

### EPA recommendations

The Environmental Protection Agency (EPA) recommends three basic strategies to improve indoor air quality:

1. **Remove sources.** The most effective ways to improve indoor air quality are to eliminate sources of pollution or reduce their emissions. This strategy can have an impact on the following pollutants:
  - Biological Contaminants such as bacteria, molds, mildew, viruses, animal dander, and pollen.
  - Household Products such as paints, varnishes, cleaning and disinfecting solutions, cosmetics and hobby products.
  - Pesticides.
2. **Ventilation.** Increasing the amount of outside air coming inside will also help to lower the concentration of indoor pollutants. Frequently allow fresh air to circulate your RV. Open the windows, exhaust vents, and doors. Operating fans, vent fans, and the roof air conditioners or furnace will help to bring in *fresh air* and force out *stale air*.
  - Keeping your RV closed, decreases the air flow, which increases the presence of indoor air pollutants.
  - Many recommendations in this manual can assist you in avoiding exposure to air pollutants and outgassed chemicals.

See the **Next Page**, *Chemical Sensitivity & Outgassing*.  
See **Page 47**, *Tips to controlling condensation*.

3. **Air Cleaners.** Air cleaners are designed to remove particles from the air. Their effectiveness depends on how well they collect pollutants from indoor air, and how much air is drawn through the cleaning/filtering element. An effective air cleaner requires both an efficient collector and a high air-circulation rate.

There are many sizes and types of air cleaners on the market. Most of the less expensive, table-top models, are much less effective at particle removal. Generally, air cleaners DO NOT remove gaseous pollutants.



**Chemical outgassing is not a defect in your RV.**

It is not covered by the Limited Base or Limited Structural Warranties. Please follow the recommendations in this section to address the concern.

## Chemical Sensitivity & Outgassing

When you first purchase your new RV, or after it has been closed for an extended time, you may notice a chemical odor due to outgassing. This is normal, and not a defect.

**Outgassing** (or *offgassing*) is the release of a chemical gas that was dissolved, trapped, frozen or absorbed in a material. The amounts released through outgassing decrease over time.

Just like in your home, RV construction uses many products such as carpet, linoleum, plywood, insulation, upholstery, etc. These new products may outgas different chemicals, including formaldehyde. This can continue over time, and in particular, when exposed to elevated temperatures or humidity.

Because RVs are smaller than a home, the exchange of air inside your RV is much less. The minimal air exchange, can make the outgassed chemicals more noticeable.

**Chemical sensitivity** may cause you to experience irritation of the eyes, nose, and throat and sometimes nausea, headache, and a variety of asthma-like symptoms. Elderly persons, young children, or anyone with a history of asthma, allergies or lung problems, may be more susceptible to the effects of outgassing.

## Formaldehyde

Most of the attention regarding chemical outgassing surrounds formaldehyde. Some people are very sensitive to formaldehyde exposure while others may have no reaction.

Formaldehyde is a naturally occurring substance. It is a key industrial chemical used in the manufacture of numerous consumer goods including products used in RV construction. Trace levels of formaldehyde are also released from smoking, cooking, and the use of many other household products like detergents, cleaners, paints, coatings and cosmetics.



If you have any questions regarding the health effects of formaldehyde or any other air pollutants, consult your doctor or local health department.

## Formaldehyde Continued

### California Air Resource Board (CARB) Notice

Formaldehyde is used widely in building materials such as pressed wood products, particleboard, hardwood plywood paneling, medium density fiberboard (MDF), and plywood which are commonly used throughout the Recreational Vehicle Industry. As mandated by the RV Industry, Grand Design RV recreation vehicles contain composite wood products (hardwood plywood, particle board, and MDF) that comply with the California Air Resource Board (CARB) formaldehyde emission standards under California Code of Regulations § 93120.2(a) Phase 2 (P2).

## Effects of Prolonged Occupancy

Your RV is designed primarily for recreational and extended stay use. Be prepared to deal with condensation and the humid conditions that may be encountered, if you plan to occupy your RV for an extended period. Modern RVs have a relatively small volume due to their compact construction. The normal living activities of even a few occupants in the RV, can lead to rapid moisture saturation of the air inside and the appearance of visible moisture, especially in cold weather.

## Condensation

Condensation refers to the water droplets that appear on a cold surface as water vapor in the air cools, changing to liquid water. In cold weather, it may be seen as frost or ice. Moisture can condense on the *inside* of an RV during cold weather the same way that moisture collects on the *outside* of a cold glass during humid weather.

Condensation may also collect out of sight within the walls or ceiling, causing warped or stained panels. Appearance of these conditions may indicate a serious condensation problem. To minimize condensation inside your RV, moisture in the air must be carried outside by ventilation, or removed with a dehumidifier (customer supplied).



Your RV is not designed, nor intended, for use as permanent housing. Use of this RV for long term or permanent occupancy may lead to premature deterioration of structure, interior finishes, fabrics, carpeting and drapes. Damage or deterioration due to long-term occupancy is not considered normal, and may under the terms of warranty, constitute misuse, abuse or neglect, and therefore void certain warranty protections.



## Tips to controlling condensation

To help alleviate excess moisture, use these tips:

- Allow excess moisture to escape to the outside when bathing, washing dishes, hair drying, laundering and using appliances and non-vented gas burners.
- Keep the bathroom door closed and roof vent opened (if equipped, exhaust fan on) when bathing/showering and for a period of time after you have finished.
- When cooking, always operate the range hood fan. Cooking releases heat and moisture that can quickly result in condensation in your RV; operating the range hood fan can be effective in removing both.
- DO NOT hang wet clothes in the RV to dry.
- Use a fan to keep air circulating inside the vehicle so condensation and mildew cannot form in dead air spaces.
- Allow air to circulate, keeping the temperature the same throughout the RV, even inside the cabinets.
  - Leave closet and cabinet doors partially open.
  - A closed cabinet full of stored goods will prevent circulation and can cause condensation.

### In hot weather

- Start the air conditioner early in the day to remove excess humidity from the air while lowering the temperature.

### In cold weather

- During cold weather it is very important to continue utilizing your vents and vent fans. This will keep the humid air inside moving to the outside. Keeping the RV tightly closed during cold weather will increase condensation.
- Manage the inside temperature during cold weather. The warmer temperatures inside your RV will cause condensation to form on areas that are not well insulated (ie., windows, vents, wall studs, etc.).



If the tips presented here are not effective in controlling condensation, it may be necessary for you to invest in a dehumidifier to reduce the health risk to you or your family as well as prevent damage to your RV.

## Where There is Moisture, There May Be Mold

Molds are microscopic organisms that can live in virtually any indoor or outdoor environment. Mold growth requires a source of moisture (ie., high humidity, wet/damp materials, standing water) and a temperature between 40° and 100° Fahrenheit.

According to the Center for Disease Control, exposure to damp and moldy environments may cause a variety of health defects, or none at all.

- For people *sensitive* to molds, mold exposure may cause nasal congestion, coughing, wheezing, and/or irritation of the eyes, throat, or skin.
- People with *mold allergies* may have more severe reactions to mold exposure. Immune-compromised people and those with chronic lung illnesses, like obstructive lung disease, risk serious lung infections.

Mold growth can be very harmful to the natural wood products and fabrics in your RV. Follow these tips to help control the relative humidity inside your RV and inhibit mold and mildew:

- While cooking and bathing, **ALWAYS** use the kitchen and bathroom vents, even during colder weather.
- In addition, opening a window will increase ventilation during these activities.
- Running your air conditioner will also reduce the relative humidity.
- In extremely humid conditions, using a dehumidifier (customer supplied) can be helpful.

## Mold Prevention

To help protect your RV from mold, follow these important preventative measures:

- Clean regularly, especially the kitchen and bathroom. On safe surfaces, use cleaning products that kill mold and mildew. .
- Any spills should be wiped up and dried right away.
- DO NOT leave any damp items inside the RV.
- Check sealants regularly. Reseal as needed to avoid water leaks.

## Cold Weather Use

Please keep in mind, that your RV is not designed for use during sub-freezing weather. If you plan to use your RV in freezing (or below freezing) temperatures, the following precautions MUST to be taken:

- The freshwater and drainage systems require added protection to avoid freezing.
- More frequent furnace operation, substantially increases battery draw and propane use. Sufficient power and propane are required to protect against possible freeze-ups on the propane regulator.
- Proper ventilation or the addition of a dehumidifier may be required to reduce condensation.
- To avoid damage to parts, CHECK the outside of the RV for ice BEFORE operating the: slide outs, compartment doors, locks, windows, vents etc.

*If you have further questions, please contact your dealer or Grand Design RV Customer Service.*

## Websites of Interest

We also recommend that you visit the following websites that maintain information about indoor air pollutants, including molds and formaldehyde, along with ways to improve indoor air quality:

- [www.epa.gov/iaq/pubs/insidestory.html](http://www.epa.gov/iaq/pubs/insidestory.html)
- [www.epa.gov/mold](http://www.epa.gov/mold)
- [www.atsdr.cdc.gov](http://www.atsdr.cdc.gov)

## Website Usage Disclaimers

Grand Design RV hereby disclaims and sets forth as follows:

### **Website Disclaimer of Warranty**

The services, information and materials on websites listed in this manual are provided "AS IS" and Grand Design RV shall have absolutely no liability whatsoever in connection with these website services, information, external links or third party links on these websites. Your use of these websites are at your own risk. Grand Design RV shall have no liability whatsoever for any errors, omissions or inaccuracies in the information regardless of how caused or for delays or interruptions in delivery of the information: or any decision made or action taken or not taken in reliance upon the information furnished.

Grand Design RV accepts no responsibility or liability whatsoever with regard to information on these websites as the information is meant to be of a general nature only and is not intended to address the specific circumstances of any particular individual or entity.

The information provided is not necessarily comprehensive, complete, accurate or up to date; the information is sometimes linked to external sites over which Grand Design RV has no control and for which Grand Design RV assumes no responsibility: Grand Design RV shall have no liability for any loss or injury caused, in whole or in part, by its actions, omissions or negligence, or for any contingencies beyond its control in procuring, compiling or delivering any information. The information is not professional nor does it comprise legal advice (if you need specific advice, you should always consult a suitably qualified professional).

## Disclaimer of Endorsement

Any reference within external or third party links to any specific commercial products, process or service by trade name, trademark, manufacturer or otherwise, does not constitute or imply its endorsement, recommendation or favoring by Grand Design RV. The appearance of external or third party links does not constitute endorsement by Grand Design RV of the linked web sites or the information, products or services contained therein.

Grand Design RV does not exercise any editorial control over the information you may find at these locations. External or third party links may be provided for the convenience of the users of that website. Grand Design RV is not responsible for the availability or content of these external or third party sites and does not endorse, warrant or guarantee any products, services, information, centers or schools described or offered at these links.

## Additional Safety Precautions

### Tire Pressure

ALWAYS check tire pressure BEFORE departing on any trip, even for short distances. For proper tire inflation pressures, refer to the *Tire Information Label*.

### Wheel Torque

- ALWAYS check the torque on *all* lug nuts. BEFORE departing on any trip, even a short distance.
- For lug nut torque specifications and patterns, refer to the Tire & Wheel section of this manual.
- ALWAYS use a calibrated torque wrench to confirm proper torque.

### Propane Appliances & Equipment

- Turn OFF all propane appliances and equipment (including the tanks) are BEFORE departing on a trip.
- Understand all propane safety warnings and follow manufacturer recommended operating procedures.
- **Propane gas is flammable, improper use may result in a fire or explosion.**

## Additional Safety Precautions, Continued

### Passenger safety

- **While your RV is in motion, DO NOT allow anyone to ride inside as a passenger.**
- In several states, this practice is against the law.

### Loading & Weight Distribution

- Distribute cargo weight evenly throughout your vehicle.
- NEVER exceed your RV's *Cargo Carrying Capacity* or *Gross Vehicle Weight Rating*.
- Place heavy items in the center of your vehicle, on the floor.
- Balance loads *front-to-rear* and *side-to-side*.

### Towing

High cross winds and the external forces created by large trucks as they pass, may cause *swaying* or *fishtailing*. This can lead to a loss of control, resulting in serious injury or death. Under these conditions, slow down and pay close attention to other vehicles.

- ALWAYS follow posted speed limits, *and*
- Adjust for weather or road conditions that can impact the stability/handling of your tow vehicle and RV.

### Vehicle / Generator Exhaust

Only operate a generator (customer supplied) in an open outdoor area where the exhaust can dissipate.

- To avoid the dangers of carbon monoxide, prevent exhaust gases from entering your RV.
- Close all entry/compartments doors, and windows near vehicle or generator exhaust.

### Air Quality

Proper ventilation of your RV is required to maintain air quality. Breathing and daily activities like cooking and bathing, add moisture to the air. This moisture can become condensation.

- Condensation inside your RV indicates that proper ventilation is NOT occurring.
- Condensation can lead to mold growth.
- In addition, proper ventilation helps remove formaldehyde which is contained in some building materials as well as a by-product of combustion.

## Pre-Travel Information

To help ensure your traveling enjoyment, update your GPS (customer supplied) and confirm that your route is planned with current road maps. Call ahead for tourist information for the areas that you will be visiting or traveling through. Research that your planned camping adventures comply with all federal, state and local regulations.

- Arrange for someone to check your house periodically while you are away. Stop mail or newspaper delivery.
- If you intend to be away for more than two weeks, you may want to consider requesting police surveillance for your house.
- Carry an extra set of vehicle and house keys with you on a separate key ring.
- Be sure to renew your license if it has expired, or will expire during your trip.
- If you are planning to visit other countries, contact the consulate nearest the point at which you plan to enter that country for the specific and most current information (including rules for re-entering the United States).

**Always carry your vehicle registration, insurance policy card(s) and warranty registration.**

### Tow Vehicle Disclaimer

- **As a minimum requirement, the towing capacity of your tow vehicle MUST be greater than the Gross Vehicle Weight Rating (GVWR) of your RV.**

Contact your automotive dealer to confirm the towing capacity of your vehicle, whether you are buying a new tow vehicle, or will tow your RV with one that you already own. Discuss the GVWR, size and type of RV that you will be towing. If you plan to purchase a new vehicle, some trucks can be purchased with an optional tow package.

Some automotive manufacturers publish brochures that discuss towing considerations. Ask your automotive dealer how to obtain a copy of this information. Verify that the weight ratings listed in the brochure are for your exact vehicle, ie, the correct year, model, engine, transmission, suspension and any relevant options.

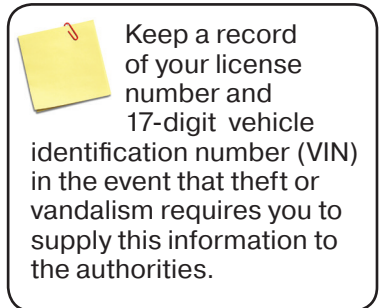

## Vehicle Labels

Decals and data plates used throughout the RV aid in its safe and efficient operation; others give service instructions. Read all decals, data and instruction plates before operating your RV. If any decal, data or instruction plate is painted over, damaged or removed, it should be replaced.

## Weight Ratings & Definitions

It is essential to understand and stay within the weight ratings of your RV and tow vehicle. Learning these definitions is the first step in safely managing your RV's weight and balance. Vehicle and trailer weight numbers fall into two categories:

- **Ratings** are maximum limits, NEVER to be exceeded. These limits are established by Grand Design RV and our component manufacturers in the design of the vehicle.
- **Weight** and **Load** are often used interchangeably. Weight is measured by putting an RV, tow vehicle or its components on a scale. Vehicles and cargo have *weight*, which impart *loads* to tires, axles, and hitches.

**GAWR (Gross Axle Weight Rating)** - GAWR is the maximum weight each axle is designed to carry.

**GVWR (Gross Vehicle Weight Rating)** - GVWR (also called *Maximum Loaded Trailer Weight*) includes the GAWR *plus* the hitch weight. It is the maximum allowed weight for a fully loaded RV or tow vehicle.

**Gross (Trailer/Vehicle) Weight** - Gross Weight is the total actual weight of your RV *plus* cargo, as measured on a scale.

**UVW (Unloaded Vehicle Weight)** - UVW is the weight of the RV as built at the factory. The UVW includes the empty LP bottles but does NOT include cargo, water, LP gas, or dealer-installed accessories.

**Hitch Weight (or Tongue Load/Tongue Weight)** - Hitch weight is the actual weight pressing down on the hitch ball by the RV.

### CCC (Cargo Carrying Capacity)

- United States: CCC is equal to GVWR *minus* the following: UVW and LP gas weight. *Water is considered cargo weight.*
- Canada: CCC is equal to GVWR *minus* the following: UVW, LP gas weight, and full fresh (or *potable*) water weight (*including the water heater*).

For additional definitions, See **Page188**, *Glossary*

 **WARNING**

Exceeding a rating may result in unsafe conditions, potential damage, may void a warranty, may complicate an insurance claim, and in some cases, may violate a law.

 **WARNING**

The actual total weight of the vehicle, all options, liquids, your personal cargo, and the hitch weight is important to know so that you do not exceed the Gross Vehicle Weight Rating (GVWR) of the recreational vehicle. The volume of space available for storage may exceed the amount of available cargo capacity. Large storage compartments have been designed to accommodate normal camping items, which are bulky, but not necessarily heavy.



# Weight Labels

Vehicle weight labels are affixed to your RV to help you make an informed decision before your purchase. Do not remove these labels. If the labels are missing, contact your dealer or Grand Design RV Customer Service for replacements.

## Federal Certification Label

This label specifies maximum capacities for GVWR, GAWR and tires. It is located on the forward, off-door-side exterior.

MANUFACTURED BY/FABRIQUE PAR: Grand Design RV, LLC DATE: 01/2013

GVWR/PNBV 7264 KG( 16000 LB)  
 GAWR(EACH AXLE)/PNBE (CHAQUE ESSIEU) 3178 KG( 7000 LB)  
 TIRES/PNEU ST235/80R16 RIMS/JANTE 16x6 8-6.5  
 COLD INFL. PRESS./PRESS. DE GONFL A FROID 552 KPA(80 PSI/LPC) SINGLE

THIS VEHICLE CONFORMS TO ALL APPLICABLE U.S. FEDERAL MOTOR VEHICLE SAFETY STANDARDS IN EFFECT ON THE DATE OF MANUFACTURE SHOWN ABOVE. THIS VEHICLE CONFORMS TO ALL APPLICABLE STANDARDS PRESCRIBED UNDER THE CANADIAN MOTOR VEHICLE SAFETY REGULATIONS IN EFFECT ON THE DATE OF MANUFACTURE. - CE VEHICULE EST CONFORME A TOUTES LES NORMES QUI LUI SONT APPLICABLES EN VERTU DU REGLEMENT SUR LA SECURITE DES VEHICULES AUTOMOBILES DU CANADA EN VIGUEUR A LA DATE DE SA FABRICATION.

V.I.N./N.I.V.: 573FS3821D1100001 TYPE/TYPE: TRAILER TRA/REM Solitude Fifth-Wheel

## Tire and Loading Information Label

This label specifies the maximum amount of cargo that can be safely added to the RV. It is located on the forward, off-door-side exterior.



**TIRE AND LOADING INFORMATION**  
**RENSEIGNEMENTS SUR LES PNEUS ET LE CHARGEMENT**

The weight of cargo should never exceed 1360 KG or 2998 LBS. Le poids de chargement ne devrait jamais excéder 1360 KG ou 2998 LBS.

TIRE PNEU	SIZE DIMENSIONS	COLD TIRE PRESSURE PRESSION DES PNEUS A FROID	SEE OWNER'S MANUAL FOR ADDITIONAL INFORMATION  VOIR LE MANUEL DE L'USAGER POUR PLUS DE RENSEIGNEMENTS
FRONT AVANT	ST235/80R16 LRE	552 KPA /80 PSI	
REAR ARRIERE	ST235/80R16 LRE	552 KPA /80 PSI	
SPARE DE SECOURS	ST235/80R16 LRE	552 KPA /80 PSI	

573FS3829H1107593

## Cargo Carrying Capacity (CCC) Label

This label supplies the CCC information for the customer. It is located on the backside of an upper cabinet door in the kitchen area.

RECREATION VEHICLE TRAILER CARGO CARRYING CAPACITY  
 VIN: 573FS3821D1100001  
 THE WEIGHT OF CARGO SHOULD NEVER EXCEED  
 1135 kg or 2500 lbs.  
 CAUTION:  
 A full load of water equals 188 kg or 415 lbs of cargo @ 1 kg/L (8.3 lb/gal)

## **WARNING**

The load capacity of your RV is designated by weight, not by volume. All available storage space cannot necessarily be used when loading the RV.

### **For the best possible handling:**

- Do not exceed your GVWR.
- Ensure you are loading the vehicle evenly.
- To prevent shifting during travel, secure heavy items.

## Cargo Capacities

When loading cargo into your RV, DO NOT exceed:

- Maximum weight specified on the Cargo Carrying Capacity label
- GVWR (Gross Vehicle Weight Rating)
- *Maximum Load Rating* of your RV tires.

The Maximum Load Rating of your RV tires is *less than* the GVWR. To calculate the actual weight on your RV tires, subtract the hitch weight from your RV's Gross Weight. The hitch weight is carried by your tow vehicle, not the RV tires.

### **For example, if your RV's:**

- Tires are each rated at 2,000 lbs.  
**2,000 lbs. x 4 tires = 8,000 lbs.**
- Gross Weight is 9,000 lbs.
- with a hitch weight of 1,200 lbs., *then*  
**9,000 lbs. - 1,200 lbs. = 7,800 lbs.**

The actual weight on the RV tires is 7,800 lbs.,  
This is under the load rating of the tires.

$$\mathbf{7,800\ lbs. \div 4\ tires = 1,950\ lbs.\ each}$$

## Water and Propane

- Your fresh water is treated as cargo weight. Water weighs 8.3 lbs. per gallon; 50 gallons weighs over 417 lbs.
- The weight of your full LP cylinders is already figured into your RV's Cargo Carrying Capacity.

If you are close to your GVWR, reducing the amount of water in the holding tank will increase the amount of cargo weight available by the same amount. This flexibility allows you to make choices that fit your travel and camping needs.

*If you have further questions, please contact your dealer or Grand Design RV Customer Service.*

## Loading Your RV

For traveling safety, distribute cargo side-to-side so the weight on each tire does not exceed one-half of the GAWR for either axle.

It is important to secure the tie down straps (if so equipped) on appliances or furniture. Free-standing furniture or overlooked items on the counter top or range can become dangerous projectiles during a sudden stop.

Store and secure all loose items inside the RV before traveling. Check that all items such as canned goods, small appliances, cooking pans, etc. are safely put away.

## Weighing Your Tow Vehicle & RV

There are two important factors when loading your RV, total weight and balance. It is imperative that you verify compliance within all applicable weight ratings. Overloading your RV will void the Limited Base Warranty and Limited Structural Warranty, and the warranties of many component part manufacturers.

Have your RV weighed periodically at a public scale to determine the proper load distribution. Keep in mind that individual scales will operate differently. The surroundings of the scale need to be adequate to accommodate weighing each side of your RV.

### To weigh your tow vehicle and RV

Read through all the weighing instructions before you begin. If you have further questions, consult with your dealer or the scale operator. Your RV must be weighed fully loaded (that is with food, clothing, fuel, water, propane, supplies, etc.).

1. Weigh the RV including the tongue weight, while detached from the tow vehicle. This actual overall weight must be less than or equal to the GVWR for safe operation. If the overall weight is greater than the GVWR, some contents must be removed until the actual overall weight is less than or equal to GVWR.

### **WARNING**

Only store items in the areas designated for storage. Do not store anything in the areas reserved for the furnace, water heater, converter, or electrical panels, etc.

### **WARNING**

Never load the RV in excess of the GAWR for either axle. Overloading the RV may result in adverse handling characteristics and damage to the chassis.

### **WARNING**

**DO NOT EXCEED YOUR GVWR!** This means you should weigh your RV as loaded for your normal travel to determine the actual weight. If you exceed the GVWR, you **MUST** remove items from the RV, or drain liquids, then re-weigh the RV to ensure you have achieved a safe weight. Do not travel with full grey/black holding tanks. This not only wastes gas but, depending upon the location of the grey or black holding tanks, can affect handling characteristics.

### **WARNING**

Total weight of your tow vehicle and RV must not exceed the GCWR. Do not assume that you can tow an RV that happens to be within the capacity of the tow vehicle hitch. By doing so, you may exceed the total GCWR of your tow vehicle and RV towing combination.

## Weighing Your Tow Vehicle & RV, Continued

2. Hitch the RV to your tow vehicle. Weigh the RV and the tow vehicle to determine the Gross Combined Weight (GCW). Make sure that this rating is less than or equal to the GCWR as specified by the manufacturer of your tow vehicle. If this overall weight is greater than the Gross Combined Weight Rating (GCWR), some contents must be removed to bring the combination into compliance with the listed ratings.
3. Weigh the RV while attached to but excluding the tow vehicle. This will result in the actual weight that is exerted on all of the RV tires. This weight may be subtracted from the overall RV GVWR to determine the actual “tongue” weight.
4. With the RV still attached to the tow vehicle, weigh each wheel position separately to ensure each tire is not overloaded.

### To determine the wheel position weight:

5. Pull the RV onto the scale so only one tire is on the scale. Record the weight. Your RV must remain as level as possible on the scale (even though an axle or side is not physically on the scale). Obviously, to obtain the side-to-side weights, there must be enough space on either side of the scale to accommodate the RV being partially off the scale.
6. To calculate the opposite side of the RV wheel position weight, subtract the first side’s weight from the weight determined in step #3.

If there is a difference in the weights on one side of the vehicle as compared to weights on the other side, components (tires, wheels, brakes, springs, etc.) on the heavier side could be overloaded, even though the total axle load is within the GAWR. It is important to redistribute the load to avoid component failure, improve the handling characteristics of the tow vehicle and not void the Limited Base Warranty and Limited Structural Warranty.

With these actual weights, it is now possible to compare them against the Trailer Weight Information label weight ratings to ensure you are below the posted minimum ratings.

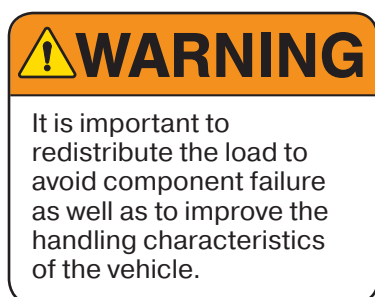

## Tire Safety Information

This portion of the Owner's Manual contains tire safety information as required by 49 CFR 575.6(4) and is based in part on the National Highway Traffic Safety Administration's (NHTSA) brochure titled *Tire Safety, Everything Rides On It*. It can be obtained from NHTSA as a free download at [http://www.nhtsa.gov/cars/rules/TireSafety/ridesonit/tires\\_index.html](http://www.nhtsa.gov/cars/rules/TireSafety/ridesonit/tires_index.html).

Studies of tire safety show that the most important things you can do to avoid tire failure, blowouts, and flat tires are:

- Maintain proper tire pressure.
- Observe tire and vehicle load limits. (NEVER carry more weight in your vehicle than your tires or vehicle can safely handle).
- Avoid road hazards.
- Drive within the designated tire speed ratings,
- Inspect tires for cuts, slashes, and other irregularities.

These actions, along with other care and maintenance activities, can also:

- Improve vehicle handling.
- Help protect you and others from avoidable breakdowns and accidents.
- Improve fuel economy.
- Increase the life of your tires.

Make tire safety a regular part of your vehicle maintenance routine. Know that the time you spend is minimal compared with the inconvenience and safety consequences of a flat tire or other tire failure.

## Safety First – Tire Maintenance

Proper tire maintenance improves the stopping distance, traction, steering, and load-carrying capability of your vehicle. As mentioned above, to prevent flat tires and other types of tire failure, you should maintain proper tire pressure, observe tire and vehicle load limits, avoid road hazards, and regularly inspect your tires.

## Recommended Tire Pressure & Load Limits

**The major causes of tire failure are *under-inflated tires* and *overloaded vehicles*.** Tire information placards and vehicle certification labels give important information on tires and load limits, *including*:

- Recommended Tire Size
- Recommended Tire Inflation Pressure
- Cargo Weight  
(the maximum cargo weight the RV is designed to carry)
- Front and Rear Gross Axle Weight Ratings (GAWR)  
(the maximum weight the axle system is designed to carry)

For the label locations and more detailed information, See **Page 55**, *Weight Labels*.

## Understanding Tire Pressure & Load Limits

**Load Limits** are determined by the tire size and the greatest amount of weight each tire can safely carry.

**Tire Pressure** is the amount of air pressure a tire requires to be properly inflated. It is measured in pounds per square inch (PSI). Tire pressure affects your RV's overall performance and provides the load-carrying capacity.

The proper tire pressure for your vehicle is referred to as the "cold inflation pressure." You will also find this number on the vehicle information placard expressed in both PSI and kilopascals (KPA), the metric measurement used internationally.

It is difficult to obtain the recommended tire pressure when the tires are not cold.

See the **next page**, *Checking Tire Pressure*.

 **WARNING**

Keep tires properly inflated. A tire that is run long distances or at high speeds while seriously under-inflated will overheat to the point where the tire may lose air suddenly and/or catch fire, possibly resulting in damage to the vehicle and its contents and/or personal injury.

 **WARNING**

Exceeding the established weight ratings for the axles, running gear, tires and wheels can lead to failure that can affect motor vehicle safety and lead to property damage or damage to the RV.

## Checking Tire Pressure

It is important to check your vehicle's tire pressure at least once a month for the following reasons:

- Most tires may naturally lose air over time.
- Tires can lose air suddenly if you drive over a pothole or other object or if you strike the curb when parking.
- With radial tires, it is usually not possible to determine under-inflation by visual inspection.

For safety and convenience, purchase a tire pressure gauge to keep in your vehicle. They are sold at auto parts stores, hardware stores and many other retail outlets.

### Steps for maintaining proper tire pressure

1. Locate the recommended tire pressure on the RV's Tire and Loading Information label located on the forward, off-door-side exterior.
2. Record the tire pressure of all tires.
  - a. If the tire pressure is too high in any of the tires, slowly release air by gently pressing on the tire valve stem with the edge of your tire gauge until you get to the correct pressure.
  - b. If the tire pressure is too low, note the difference between the *actual* measured tire pressure, and the correct tire pressure. These "missing" pounds of pressure are what you will need to add.
3. At a service station or using an air compressor, add the missing pounds of air pressure to each tire that is under-inflated.
4. Check all the tires to make sure they have the same air pressure.

If you have been driving your vehicle and think that a tire is under-inflated, fill it to the recommended cold inflation pressure indicated on your vehicle's Tire and Loading Information label. While your tire may still be slightly under-inflated due to the extra pounds of pressure in the warm tire, it is safer to drive with air pressure that is slightly lower than the vehicle manufacturer's recommended cold inflation pressure than to drive with a significantly under-inflated tire. Since this is a temporary fix, do not forget to recheck and adjust the tire's pressure when you can obtain a cold reading.

### **WARNING**

Always check tire pressure when tires are cold. Cold tire inflation pressure is defined as a tire that has not been used for three or more hours, or has been driven less than one mile. Tire inflation pressure of a hot tire may show an increase as much as 6 PSI over a cold tire. Do not exceed the maximum recommended pressure.



## DANGER

If the total weight of the RV exceeds the GVWR, the trailer is overloaded.

Operating your RV while exceeding the specified weight ratings increases the risk of a crash, personal injury and death.

It is necessary to remove payload (equipment, water, personal belongings, etc.) until the total weight of the RV no longer exceeds the GVWR before operating the RV.



## DANGER

If the weight on the trailer axles exceeds the GAWR, the axles are overloaded.

Operating your RV while exceeding the specified weight ratings increases the risk of a crash, personal injury and death.

It is necessary to remove or rearrange payload (equipment, personal belongings, water, etc.) until the axle weight no longer exceeds the GAWR before operating the unit. Not operating your RV within the designed weight ratings can damage your recreational vehicle which is not covered under warranty.

## How Overloading Affects Your RV and Tires

The results of overloading can have serious consequences for passenger safety. Too much weight on your vehicle's suspension system can cause spring, shock absorber, or brake failure, handling or steering problems, irregular tire wear, tire failure or other damage. An overloaded vehicle is hard to drive and hard to stop. In cases of serious overloading, brakes can fail completely, particularly on steep hills. The load a tire will carry safely is a combination of the size of tire, its load range, and corresponding inflation pressure. Excessive loads and/or under-inflation cause tire overloading and, as a result, abnormal tire flexing occurs. This situation can generate an excessive amount of heat within the tire. Excessive heat may lead to tire failure.

It is the air pressure that enables a tire to support the load, so proper inflation is critical. Since RVs can be configured and loaded in many ways, air pressures must be determined from actual loads (determined by weighing) and taken from the load and inflation tables provided by the tire manufacturer. These air pressures may differ from those found on the certification label. However, they should never exceed the tire limitation for load or air pressure. If you discover that your tires cannot support the actual weights, the load will need to be lightened.

### Steps For Determining Correct Load Limit

1. Locate the statement "*The weight of cargo should never exceed XXX KG or XXX LBS*" on your RV's Cargo Carrying Capacity label.
2. This figure equals the available amount of cargo and luggage load capacity.

Determine the combined weight of luggage and cargo being loaded on the RV. That weight may not safely exceed the available cargo and luggage load capacity.



## Tire Safety Tips

### Preventing tire damage

- DO NOT run over curbs or foreign objects in the roadway or when parking.
- *Slow way down* if you can not avoid a pothole or other object in the road.

### Tire safety checklist

1. Check tire pressure *at least* monthly, including the spare.
2. Inspect tires for uneven wear patterns on the tread, cracks, foreign objects, or any other damage.
3. Carefully remove bits of glass or foreign objects wedged in the tread.
4. Check that all tire valves have valve caps.
5. Check tire pressure before going on any trip.
6. DO NOT overload your vehicle.
  - Check the *Tire and Loading Information* label.

## Tire Labeling

Federal law requires tire manufacturers to place standardized information on the sidewall of all tires. This information identifies and describes the fundamental characteristics of the tire and also provides a tire identification number for safety standard certification and in case of a recall.

## US DOT Tire Identification Number (TIN)

This begins with the letters “DOT” and indicates that the tire meets all federal standards. The next two numbers or letters are the plant code where it was manufactured, and the last four numbers represent the week and year the tire was built. For example, the numbers 3197 means the 31st week of 1997. The other numbers are marketing codes used at the manufacturer’s discretion. This is the number used to identify a tire in the event of a recall.

## Tire Size

To maintain tire safety, purchase new tires that are the same size as the vehicle's original tires or another size recommended by the manufacturer. Look at the Tire and Loading Information label, or the sidewall of the tire you are replacing to find this information. If you have any doubt about the correct size to choose, consult with the tire dealer

## Tire Size & Type Designation

For example the tires on your unit may be marked with a designation of standard trailer (ST) 225/75R15 or light truck (LT) 235/85R16. The designation breakdown is as follows:

- The first three-digit number gives the width in millimeters of the tire from sidewall edge to sidewall edge. In general, the larger the number, the wider the tire.
- The next two-digit number after the "slash" mark, known as the aspect ratio, gives the tire's ratio of height to width.
- R – The "R" stands for radial.
- The last two-digit number is the wheel or rim diameter in inches.



Because tires are designed to be used on more than one type of vehicle, tire manufacturers list the "maximum permissible inflation pressure" on the tire sidewall. This number is the greatest amount of air pressure that should ever be put in the tire under normal driving conditions.

## Maximum Permissible Inflation Pressure

This number is the greatest amount of air pressure that should ever be put in the tire under normal driving conditions.

## Speed Rating

- Typically tires with a ST designation are speed restricted to 65 mph under normal inflation and load conditions.
- Typically tires with a LT designation are speed restricted to 75 mph under normal inflation and load conditions. Do not exceed these speed ratings regardless of the posted maximum speed limit.

***Tires are warranted by the tire manufacturer, not by Grand Design RV.***

*If you need tire warranty assistance, please contact your dealer or refer to the tire warranty pamphlets provided with your RV.*

## Tire Tread

The tire tread provides the gripping action and traction that prevent your vehicle from slipping or sliding, especially when the road is wet or icy. In general, tires are not safe and should be replaced when the tread is worn down to 1/16 of an inch.

**Tread wear bars** are raised sections built into the bottom of a tire's tread grooves that show how much tread is remaining. When they appear “even” with the outside of the tread, it is time to replace your tires.







**The Penny & Quarter Test.** Place a penny or quarter upside down into the tire groove. If you can see the top of Lincoln’s head, you are ready for new tires. If you can see the top of Washington’s head, tires are OK but close to wearing out.



Tire Tread Wear Bars



**Inspect your tires regularly for uneven tread wear.**

Wear Pattern	Possible Cause	Solution
 <b>Edge Wear</b> Thin Tread Wear on Tire Edges	Under Inflation	Fill tire with an air compressor to the Recommended Cold Tire Pressure
 <b>Center Wear</b> Thin Tread Wear Center of Tire	Over Inflation	Press tire valve stem, slowly release air until reaching the Recommended Cold Tire Pressure
 <b>Side Wear</b> Exaggerated Inner or Outer Tread Wear	Loss of Camber or Overloading	Make sure your load does not exceed the axle rating.
 <b>Toe Wear</b> Thin Inner or Outer Edge	Alignment or Incorrect Toe-in	Correct Toe-In is 0 - 0.5 degrees
 <b>Cup Wear</b> Diagonal “Scalloped” Tread Wear	Loose Bearings or Wheel Balance	Check Bearing Adjustment and Tire & Wheel Balance
 <b>Flat Spots</b> Flat Spots or Patchy Tread Wear	Tire Skidding Wheel Lock Up or Out of Balance	Avoid Sudden Stops Adjust Brakes Check Tire & Wheel Balance

## Tire Ply Composition & Materials

A tire is built from multiple layers of rubber-coated fabric. Each layer is called a ply. In general, the higher the number of plies in a tire, the more weight it can support. Tire manufacturers must report all materials used in the composition of the tire, ie., steel, nylon, polyester, etc.

## Maximum Load Rating

This *Maximum Load Rating* indicates the maximum load in kilograms and pounds that can be carried by the tire.

## Spare Tire

The spare tire is used if a trailer tire is damaged, flat, or loses air pressure. The spare tire/wheel may differ from the original equipment, and is intended for temporary use only.

The spare tire is secured below your RV. Locate the 1" access hole in the skirt metal on the door-side of your RV, approximately even with the spare tire.

- Insert the crank handle extension.
- Turn **counter-clockwise** to lower the spare tire.
- Turn **clockwise** to raise the spare tire.



*Spare Tire, Access Hole  
& Crank Handle Extension*

**WARNING**

Before working underneath the RV, both the front and rear axles should be supported with jack stands. Failure to do so may result in serious injury or death.

## Tire Changing Basics

*A Hydraulic Jack and Jack Stands are customer supplied.*

1. See **Page 68**, *Roadside Emergency*.
2. Block the wheels on the opposite side from the tire you wish to change. This will prevent accidental movement.
3. Loosen the wheel lugs BEFORE raising the RV.
4. Place a *Hydraulic Jack* on the frame close to the spring hanger. Raise the trailer until the tire clears the ground  
**NEVER attempt to use a stabilizer jack to lift the RV.**
5. Set up a *Jack Stand* under the frame just to the rear of the tire being changed, *then* change your tire.
6. Follow the Wheel Nut Torque and Wheel Installation instructions provided on the **Next Page**.

## Wheel Nut Torque

Torque is the amount of rotating force applied to a fastener, such as a lug nut. The axle and wheel assemblies of your RV are designed differently than those on your car. The overall size, weight and center of gravity subject the wheels to pressures unique to trailering. During normal cornering, the tires and wheels experience a considerable amount of stress called *side-load*. Therefore, the lug nuts on your RV frequently require torque maintenance.

- ALWAYS use a properly calibrated torque wrench to confirm proper torque.
- ALWAYS check lug nut torque on each wheel before departure, regardless of how short the trip may be.
- DO NOT allow *under-torque* or *over-torque* on any wheel.
- Tighten the lugs in the correct order for your RV's lug pattern shown in the diagram. (*Right*)

Find your RV's wheel size on the table (*Below*). Tightening the lugs should be done in three stages. Determine the correct torque for each stage, and use the torque sequence shown.

Wheel Size	Stud Size	Torque Sequence		
		1st Stage	2nd Stage	3rd Stage
14"	1/2"	20-25	50-60	90-120
15"	1/2"	20-25	50-60	90-120
16"	1/2"	20-25	50-60	90-120
16.5" x 6.75"	1/2"	20-25	50-60	90-120
16"	9/16"	20-25	60-70	120-130
16.5" x 6.75"	9/16"	20-25	60-70	120-130
17.5" w/ long nut	5/8"	50-60	100-120	190-210
17.5" w/ flange nut	5/8"	50-60	150-200	275-325
14.5" demount	1/2"	Tighten sequentially to 85-95		

\* NOTE: All torque in ft.-lbs.

**! WARNING**

Always torque the wheel nuts to the specifications of the wheel manufacturer.

Over or under-torqued wheel nuts can cause the wheel to separate from the wheel mounting surface during operation, causing property damage, personal injury or loss of life.

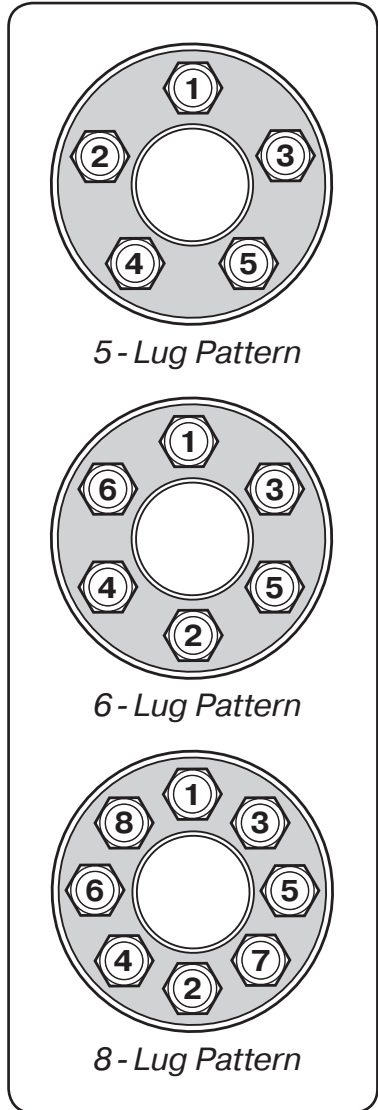

## Roadside Emergency

A roadside emergency can happen at any time. **ALWAYS** carry an emergency kit with three red warning signs (*or indicators*) to display if necessary.

### **If you must make an emergency roadside stop:**

- Pull off the road as far as possible.
- Turn **ON** the hazard warning flashers (*or hazard lights*) to alert other drivers.
- The hazard warning flashers warn passing drivers to approach and overtake your vehicle with caution.

Use the three red warning indicators (signs, reflectors, lanterns, or road flares) as follows:

1. Place the **1st** indicator **10 feet behind** the RV on the off-door (*or road*) side.
  2. Place the **2nd** indicator **100 feet behind** the RV in the center of the lane.
  3. Place the **3rd** indicator **100 feet in front** of the RV in the center of the lane.
- *10 feet = 4 paces, 100 feet = 40 paces*
  - Curves and/or hills may affect the safe placement of the warning indicators.

**For your personal safety, ALWAYS stand off the road and away from traffic.**

## Emergency Towing

If you require towing, please contact an emergency road service provider or a qualified service facility for assistance.

## Towing & Leveling

To improve safe driving and help protect against injury, please follow these recommendations:

- Keep the RV and tow vehicle tires properly inflated, *and* Replace the tires BEFORE they are excessively worn.
- ALWAYS wear your seatbelt and obey all traffic laws.
  - DO NOT exceed the posted speed limit.
  - Many states have *lower* speed limits for tow vehicle/RV combinations.
- ALWAYS be a courteous and alert driver.
  - Watch out for other drivers, bicyclists and pedestrians.
  - Pay attention to traffic and road conditions.
  - BEFORE changing lanes, check the outside rearview mirrors for other vehicles and use your turn signals.
  - Leave room for sudden braking and other unexpected events.
- ALWAYS use the daytime running lights on your tow vehicle to increase visibility to other drivers.
- NEVER drive when you are sleepy or tired.
- NEVER drive when alcohol, drugs or medication have affected your judgment, reflexes or alertness.
- Adverse weather conditions or extreme terrain may affect your tow vehicle's performance and handling.
  - DO NOT use the tow vehicle's cruise control on icy, wet, or winding roads; or any other traffic situations where a constant speed could be dangerous.

### Propane Safety

- ALWAYS shut OFF the propane system at the LP cylinder BEFORE you travel.
- If you drive with the propane system ON, the dangers are greatly increased in the event of an accident or fire.
- While you travel, most refrigerators will keep food cold or frozen for eight hours without running.

### WARNING

Do not leave children or pets unsupervised in or around the RV (even if children are secured by a child restraint system).

They could:

- Injure themselves on parts of the RV.
- Unlock and open the entry door or open the emergency exit window and possibly injure other person(s) or damage property.
- Get out of the RV and injure themselves or they could be injured by passing vehicles.
- Be seriously or even fatally injured by prolonged exposure to extreme heat or cold.

### WARNING

You must observe the law if you are driving when operating a cell phone in your tow vehicle. If it is permitted to operate a cell phone while the tow vehicle is in motion, you must only operate it when road and traffic conditions permit. You may otherwise be distracted from the traffic conditions, cause an accident and injure yourself and others.

## RV Driving Schools & Seminars

If you have any concerns about driving while towing a RV, consult an expert for specific RV driver education. There are private RV schools and some RV owner's organizations that offer driving seminars. The schedules and locations of the various RV driver education seminars and schools can be researched through RV-related publications and websites.

Please use caution when using websites as a resource tool. Verify the information is from a credited and reliable source in the RV industry, and pertains to your specific RV. If in doubt, contact your dealer for assistance.

## RV Braking System

The RV brakes are designed to work with your tow vehicle brakes. To maintain proper braking performance, both the RV and tow vehicle brakes must be used together. Separate use of the braking systems will cause accelerated wear and damage. When your RV is new, it is impossible to adjust the brake shoes precisely. It takes approximately 1,000 miles and/or 50 medium to heavy stops to "burnish" fit or "seat" the shoes to the brake drum. After the initial break-in period, your brake shoes must be adjusted accurately for best performance and increased durability.

### **Braking system components include:**

- Tow vehicle battery
- Brake controller
- Wire harness/connector plug
- Auxiliary batteries (see Electrical System)
- Breakaway switch

## Tow vehicle battery

The tow vehicle battery is the primary source of power for your RV's brake operation. To ensure available power when needed, keep your tow vehicle battery and charging system working properly.



## Battery Isolator (customer supplied)

You may want to install a *battery isolator* on your tow vehicle. A *battery isolator* is a device that:

- Receives current from the tow vehicle alternator to independently charge both the RV auxiliary battery and the tow vehicle battery.
- Prevents the RV from draining your tow vehicle battery (so you can start your tow vehicle engine).

*Your dealer can assist you with the selection, purchase and installation of this aftermarket part.*

## Brake Controller (customer supplied)

The brake controller should be installed in the tow vehicle to work in conjunction with the RV electric brakes. Consult with your dealer or the brake controller OEM to decide what is right for your towing combination.

## 7-Way Wire Harness/Connector Plug

A 7-way wire harness/connector plug is wired into your FW to connect electrical power from the tow vehicle for travel. This supplies power to the RV brakes, tail lights, clearance lights, turn signals, brake lights, etc. Wiring to operate your brakes must be the same size in both the tow vehicle and RV.

### Maintenance

The connector plug may build up corrosion with extended use and should be cleaned periodically to insure good electrical contact. Make sure the connector plug is kept clean and protected from road elements as you travel.

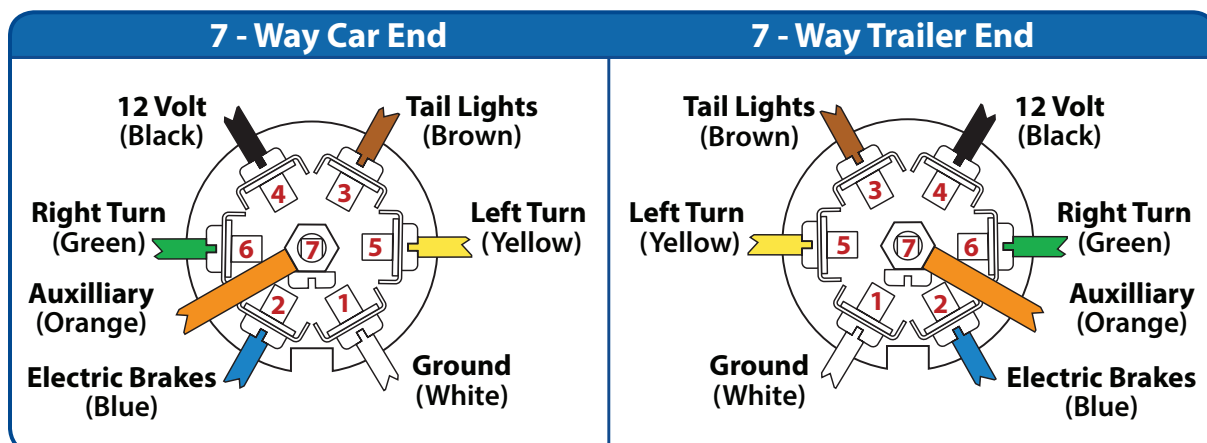

 **WARNING**

Be certain there is enough “slack” in the lanyard (cable) to accommodate a tight radius turn. Failure to do so may result in the breakaway pins pulling out of the housing causing the brakes to engage while towing. This could result in significant damage.

 **WARNING**

NEVER use the breakaway switch and trailer brake system as a parking brake. Doing so would create a high amp draw on the battery and converter. This can cause non-warranty damage to wiring, connectors and the breakaway switch.

 **WARNING**

The rating of the hitch package purchased should be equal to (or greater than) the RV's GVWR and Pin Box rating.

 Do not remove the following label from the pin box:

**SAFETY BREAK-AWAY SWITCH WILL NOT OPERATE**  
unless connected to a power source equivalent to or greater than an automotive type 12 volt, 12 amp hour wet-cell battery.

## Breakaway Switch

The breakaway switch is located by the FW pin box. It is a crucial part of the RV braking system. If the RV becomes detached from the tow vehicle, the lanyard pulls the pin from the breakaway switch, which automatically activates the RV brakes..

- While hitching the RV, ALWAYS secure the breakaway switch lanyard to a permanent part of the tow vehicle.
- Check that your auxiliary battery (customer supplied) is correctly installed, and fully charged BEFORE travel.

***An auxiliary battery (customer supplied) MUST be installed to provide power to the breakaway switch.***

## Fifth Wheel (FW) Pin Box Hitch

Hitch selection is important because it affects the towing and handling characteristics of your RV. There are many kinds of hitches available for various uses and assuring that you have the correct hitch installed is critical to a safe towing experience. The factory installed FW pin box is not interchangeable.

Ask your dealer about the proper class and type of hitch you need to purchase for your individual tow vehicle/RV combination. A FW requires a pin box hitch bolted directly to the floor of the truck box through the frame. Before selecting a hitch, you must know your GVWR and pin box rating.

### Fifth wheel pin box height

There is no recommended hitch height for fifth wheels; usually the FW pin box is adjustable for variance in trucks and truck suspension systems. Adjust the hitch assembly so the tow vehicle and the FW are essentially level. A high hitch will transfer weight behind the axles and cause the vehicle to fishtail. A low hitch will transfer additional weight to the hitch.

*To adjust the weight distributing hitch to the proper height, Please refer to the hitch manufacturer instructions.*

## Welded Rear Hitch (If So Equipped)

- **DO NOT exceed the Hitch Weight Ratings for your Welded Rear Hitch (If So Equipped). Failure to do so may void the warranty.**

## Fifth Wheel Hitching Procedure

The FW hitching procedure (below) becomes easier with practice. To safely hook up your FW to your tow vehicle, use the following steps:

1. ALWAYS use wheel chocks to block the trailer wheels.
2. Check that your hitch lever is in the open (or *cocked*) position.
  - *Unless it is designed to open automatically.*
3. Adjust the FW pin to the proper height.
4. OPEN the truck tailgate.
  - *Unless your truck is equipped with a tailgate designed to accommodate a FW hitch.*
5. Back up your truck so the hitch encircles the FW pin.
6. Making gentle contact of the hitch saddle against the pin will cause the mechanism to close.
7. Secure the hitch lever as specified in the manufacturer.
  - Shift the truck into drive, *but*
  - **DO NOT** press on the accelerator.
  - *Bump* the hitch to make sure it is locked.
8. Check that the FW landing legs are fully RETRACTED.
9. Attach the breakaway switch cable to the tow vehicle. Leave enough slack to accommodate tight turns.
10. Connect the 7-way wire harness from the FW to your tow vehicle and secure in the travel position.
11. Walk around the RV to verify the exterior lights are working correctly,
12. Remove the wheel chocks from the trailer wheels.

### **WARNING**

Maximum hitch load capacity 300 lbs. (136 kg) Exceeding load limit may void the warranty. Failure to follow the instructions could cause an accident resulting in death or serious injury.

### **WARNING**

NEVER allow anyone to go under the RV while it is being lifted and/or towed.

 **WARNING**

Towing items behind RV or overloading the rear will void the warranty and may result in damage to the RV or add-on items, towing difficulties, property damage and/or personal injury.

 **WARNING**

NEVER allow anyone to go under the RV while it is being lifted and/or towed.

## Towing the RV

You will find that your RV will travel safely and comfortably at most posted trailer highway speed limits. However, it will take longer than a passenger automobile to reach that speed. Keep this in mind when overtaking and passing another vehicle. Allow more time to go around the vehicle you are passing. You cannot cut back into the traffic lane as quickly due to the longer length of your tow vehicle/RV combination. Drive with caution to avoid situations that might require quick momentum changes.

The required stopping distance is greatly increased when towing an RV. Even though your RV is equipped with brakes designed for GVWR, we suggest practicing stopping away from traffic until you become accustomed to your RV's stopping distance. A good way to practice is at a large parking lot (where it is permissible). Easing to a stop and starting smoothly saves wear and tear on your tow vehicle/RV combination.

Be aware of road surface conditions. Slow down well in advance of dips and bumps to reduce the jolting to your tow vehicle/RV combination. Drive over them slowly and let the trailer tires pass over them before accelerating. Cross railroad tracks slowly (always release your brakes before crossing).

When descending a long hill, drop down into a lower gear (or lower range if you have automatic transmission). Avoid conditions that require excessive and prolonged use of your brakes. Apply and release brakes at short intervals to give them chance to cool. The tow vehicle transmission and engine will help in controlling downhill speed and can lengthen brake life.

Use care when accelerating or decelerating on a slippery surface. Abrupt speed changes can cause skidding and loss of control. Driving through water deep enough to wet the brakes may affect stopping distance or cause the vehicle to pull to one side. Check the RV's brake operation in a safe area to be sure they have not been affected. Never operate any vehicle if a difference in braking efficiency is noticeable.

## Passenger safety

- **While your RV is in motion, DO NOT allow anyone to ride inside as a passenger.**
- In several states, this practice is against the law.

## Weight and Clearance Limits

In order to obey all posted weight and clearance limits, you **MUST** *always* know the weight and height of your RV/tow vehicle combination.

- ALWAYS include the roof air conditioners, TV antennas, and floodlights as they may cause clearance problems under some tunnels, canopies or hanging signs.
- Some bridges, older ones in particular, may not support the weight of your RV/tow vehicle combination.

## Turning Corners

When turning, the tires do not follow the path of your tow vehicle tires. The RV will make a tighter turn than the tow vehicle. You must compensate for this action by carefully pulling the tow vehicle out into the intersection further than you would normally so that the RV clears the curb (or any parked vehicles along the curb).

## Backing up

If there are no pull through sites at your camping destination, choose a level site and back in carefully. **BEFORE** you park, exit your tow vehicle, and inspect that site conditions are satisfactory.

- Check that you have plenty of vehicle clearance.
- Check that your path is free of obstacles. (ie., low-hanging tree limbs, posts, large rocks)
- Try to choose a site that is on the driver's side, so that you can easily see the rear of the RV.
- A site on the passenger side is more difficult, since you back into the site on your blind side.
- Position your tow vehicle and RV for backing into the site.
- Back up the RV slowly. Watch your tow vehicle mirrors and *Back Up Camera* (customer supplied) carefully to help you guide the RV into the site.
- Have another person outside the RV to assist you until the RV is parked in the desired position.

## **WARNING**

When making a turn, check the road clearance and be aware of others. Have someone help guide you out of a difficult parking space or traffic pattern. Swerves and sharp turns, especially at high speeds, could result in loss of control of the RV.



If the parking spot is on asphalt on a very hot day or on dirt and/or gravel, a block of wood under each jack leg can be used to spread the load and reduce the possibility of the leg sinking into the surface.

## Towing the RV, Continued

### Parking

After the RV is in the desired location, set the tow vehicle parking brake and place the transmission in park. Turn OFF the ignition switch. Go outside and block the RV wheels securely with wheel chocks. The wheel chocks can be wood blocks or purchased items as long as they prevent the RV from rolling.

### FW Setup

1. Choose a place to park, and pull the RV into the site.
2. Block the wheels to keep the RV from rolling.
3. LOWER the landing legs to stabilize the RV.
  - *For proper operation, it is important to follow the manufacturer's instructions.*
4. Disconnect the wire harness/connector plug.
5. Disconnect the breakaway switch lanyard.
6. OPEN the truck tailgate.
  - *Unless your truck is equipped with a tailgate designed to accommodate a FW hitch.*
7. Shift your truck into reverse, *but* **DO NOT press on the accelerator.**
  - This moves the kingpin off the locking bar, so that it can be disengaged.
8. Apply the brakes, *then* set your parking brake.
9. Disengage the locking bar, *then* Unhitch the RV.
10. Pull away your tow vehicle.
11. Level the RV front to back by adjusting the fifth-wheel height.

## Leveling the RV

With the unit parked, the next step is to level your RV. A small level should be used in the refrigerator, and on the counter top or floor to confirm the RV is level.

### Leveling your RV is important

- The refrigerator (and other appliances) are designed to perform best when the RV is level.
- The water system is designed to drain properly when the RV is level.
- Sleeping and walking inside is more comfortable when the RV is level.

### **BEFORE you operate the leveling system, ALWAYS make sure that:**

1. The RV is parked on a mostly level surface.
2. The tow vehicle is disengaged from the RV.
3. All persons, pets and property are clear of the RV while the leveling system is in operation.

### Landing Legs

The landing legs are used to position the unit while hitching and unhitching from the tow vehicle, They stabilize the fifth wheel during camping and storage.

DO NOT use the landing legs to raise the tires off the ground. They are not designed to support the full weight of the RV to change tires or service the fifth wheel.

The landing legs are made up of three steel tubes that slide inside of each other, either a hand crank or electric motor drive that turns gears, a screw-drive shaft in each leg to extend or retract the legs, foot pads, pull pins and related hardware.

### **WARNING**

DO NOT USE THE FW LANDING LEGS TO SUPPORT THE TOW VEHICLE WEIGHT.

The FW landing legs are designed to bear the front loaded weight of the RV only.

### **NOTICE**

**Ensure that the RV is level before operating the slideout room.**

Water leaks and other problems could result if the slideout is operated without leveling the RV.

### **NOTICE**

The FW landing legs must be fully retracted before moving or towing the RV to prevent damage.

### **NOTICE**

The landing legs may bind in overload conditions, resulting in premature wear of the drive gear and stripping of the gear. Premature gear wear will also occur with excessive clutching of the motor - this occurs at maximum extension and retraction. Once clutch noise is heard, release the landing leg control switch.

## Lippert Ground Control 3.0 System

### Prior to operation

1. The trailer is parked on a reasonably level surface.
2. Be sure all persons, pets, and property are clear of the trailer while the leveling system is in operation.
3. Make sure battery(ies) are fully charged and test at 12+VDC under load.

### Ground Control 3.0 Touchpad

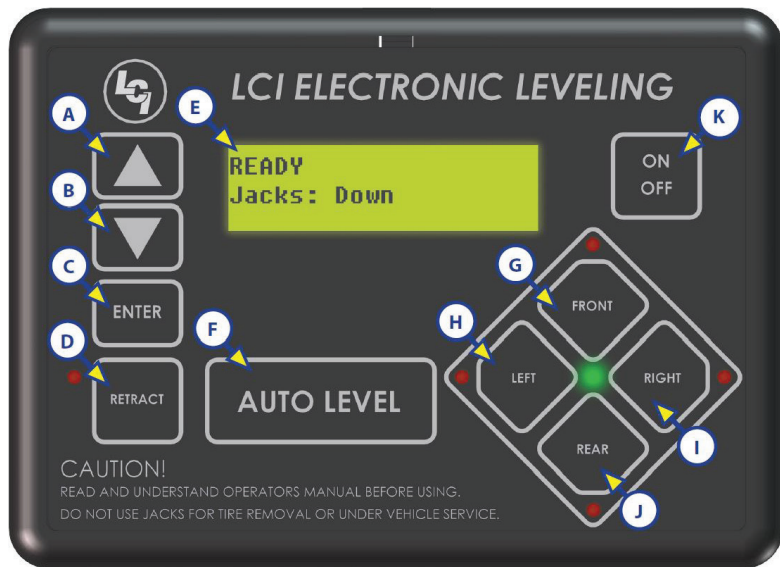

Fig. 1

Callout	Description
A	Up Arrow - Scrolls up through the menu on LCD.
B	Down Arrow - Scrolls down through the menu on LCD.
C	Enter - Activates modes and procedures indicated on LCD.
D	Retract - Places leveling system into retract mode. - Press and hold down for 1 second to initiate Auto Retract.
E	LCD Display - Displays procedures and results
F	Auto Level - Places leveling system into auto level mode.
G	Front Jack Button - Activates front jacks in manual mode.
H	Left Jack Button - Activates left jacks in manual mode.
I	Right Jack Button - Activates right jacks in manual mode.
J	Rear Jack Button - Activates rear jacks in manual mode.
K	Power Button - Turns leveling system on and off.



## Basic jack operation

Landing gear (or front jacks) can be operated any time the system is *ON*. By pushing the *FRONT* button (Fig. 1G), both front jacks can be extended. By pushing either the *FRONT* and *LEFT* (Fig. 1H) or *FRONT* and *RIGHT* (Fig. 1I) buttons, the individual front jacks can be extended. If the touch pad is put in the *retract* mode, indicated by the orange illuminated LED next to the *RETRACT* button (Fig. 1D), the front jacks can be retracted together by pushing the *FRONT* button (Fig. 1G) or individually by pressing *LEFT* (Fig. 1H) or *RIGHT* (Fig. 1I) buttons, while simultaneously pressing the *FRONT* button (Fig. 1G).

The rear jacks can only be extended when the touch pad is in the manual mode. Once system is in manual mode, pressing the *REAR* button (Fig. 1J) will extend both rear jacks at the same time. To extend individual rear jacks, press the *LEFT* (Fig. 1H) or *RIGHT* (Fig. 1I) buttons while simultaneously pressing the *REAR* button (Fig. 1J), depending on which jack needs to be operated.

If the touch pad is put in the retract mode, indicated by the orange illuminated LED next to the *RETRACT* button (Fig. 1D), the rear jacks can be retracted together by pushing the *REAR* button (Fig. 1J) or individually by pressing either the *LEFT* (Fig. 1H) or *RIGHT* (Fig. 1I) buttons, while simultaneously pressing the *REAR* button (Fig. 1J).



Ground Control 3.0  
Landing Gear / Front Jack

## Lippert Ground Control 3.0 System Continued

### Unhitching from a Tow Vehicle

**NOTE:** Prior to unhitching from the tow vehicle, ensure the trailer is parked on a level surface and be sure to chock the tires of the trailer.

1. Disconnect the 7-way plug and the breakaway lanyard (cable).
2. Extend the inner legs of both landing gear (front jacks) to show no more than 6 pin holes by pulling on the quick-release pins. Make sure pin is FULLY re-engaged.
3. Push “ON/OFF” (Fig. 1K). LCD Screen will light up and display “READY JACKS: UP” (Fig. 2A).
4. Push the “UP” arrow (Fig. 1A) to scroll to “Drop Front Jacks” option on LCD screen.
5. Red indicator lights (Fig. 2B) may come on, indicating the current disposition of the trailer. In this case, the front and right sides of the trailer are low.
6. Push “ENTER” (Fig. 1C). Both front jacks will go ground and stop.
7. Push the “FRONT” button (Fig. 1G) extending the front jacks to a sufficient height, which raises the front of the trailer off of the tow vehicle’s 5th wheel hitch plate. Be sure to pull the hitch release lever.
8. Pull tow vehicle away and park at a safe distance.

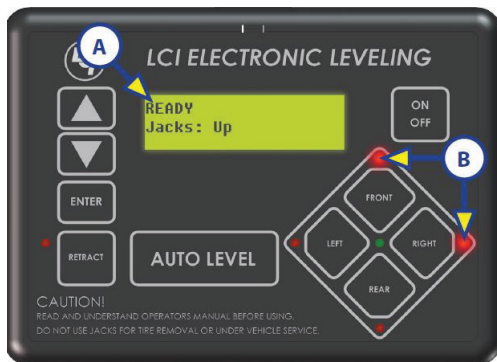

Fig. 2



Fig. 3

## Auto Level

1. After unhitching from tow vehicle and parking the vehicle at a safe distance away from the trailer, press the “ON/OFF” button and then press “AUTO LEVEL” (Fig. 1F).

**NOTE:** Once the automatic leveling cycle has been started, it is important that there is no movement in the trailer until the trailer has completed the leveling process. Failure to remain still during the leveling cycle could have an effect on the performance of the leveling system.

**NOTE:** In order for hitch recognition feature to function, the auto level sequence **MUST** be started with the front of the trailer above level.

## Auto Level Sequence

1. When Auto Level Sequence begins, the front of the trailer will lower slightly to a point below level.
2. Rear jacks will be grounded.
3. A side to side leveling sequence occurs.

**NOTE:** At this point on the 6 point system, the 2 middle jacks are grounded to stabilize the trailer. These 2 jacks do not level the trailer.

4. Each jack will perform a final grounding touch.
5. LCD will read “AUTO LEVEL SUCCESS”(Fig. 3).
6. LCD will then read “READY Jacks: Down”, and the green LED at the center of the (Fig. 4A) jack buttons will be illuminated (Fig. 4B).



Fig. 4



Fig. 5

## Lippert Ground Control 3.0 System Continued

**Note:** If the AUTO LEVEL sequence does not perform as described, place the system in manual mode. Test that the jacks operate correctly by pushing their coordinating buttons on the touch pad; i.e. the *FRONT* button operates only the front jacks, etc.

### Hitch Recognition

1. Turn on the touch pad.
2. Push the *UP* arrow (Fig. 5A) to scroll to *Auto Reconnect* option on LCD screen.
3. Push *ENTER* (Fig. 5B). The rear jacks will retract first, then the front jacks will extend to raise the trailer to the height where the auto level sequence was started.

**NOTE:** If the auto level sequence was started with the front of the trailer in a below-level condition, the Hitch Recognition will not function and the LCD will display *Feature Disabled*. In order for the Hitch Recognition feature to function, the auto level sequence **MUST** be started with the front of the trailer above level.

Once the RV is stabilized, continue setting up the RV by connecting to the site facilities, extending the slideouts, etc., according to your personal preferences and needs. There is no particular order to set up procedures, and with practice you will find the order that is the most efficient for your needs.

### Preventive Maintenance

1. For optimum performance, the system requires full battery current and voltage. The battery **MUST** be maintained at full capacity.
2. Check the terminals and other connections at the battery, the controller, and the jacks for corrosion and loose or damaged connections.
3. Remove dirt and road debris from jacks as needed.
4. If the jacks stay in the extended position for long periods they require protection from the elements. Spray the exposed leveling jack rods with a silicone lubricant every 3 months. If the trailer is located in a salty environment, spray the rods every 4-6 weeks.

## Electrical Systems

The electrical system on your Reflection FW. is comprised of two independent electrical systems. One system is 120-volt 60hz AC power, and the other is 12-volt DC power.

All installations meet or exceed industry standards applicable on the date of manufacture. The electrical equipment and associated circuitry are engineered into a dedicated system specific to your RV. Unauthorized changes or adding fixed appliances is NOT recommended. Changes or additions made after delivery may result in a hazardous condition.

Service and/or modification of the RV electrical system should only be performed by qualified electrical technicians. The methods, components, and materials used must be in compliance with current safety and code requirements. Please consult your dealer's service department for assistance.

### Electrical System Maintenance

- ALWAYS disconnect the negative 12-volt DC battery terminal and the shore power cord BEFORE working on the electrical system.
- ALWAYS turn OFF the power converter, BEFORE disconnecting the battery.

*For more information on your RV's electrical system, See the component manuals in your Owner Information Package.*

### 30-Amp or 50-Amp Power Cord

The power cord (or *shore power cord*) connects your RV to an external power receptacle. This heavy duty cord has a dual purpose.

- It carries voltage and current to your RV from the external power receptacle, *and*
- Grounds your RV electrical system through the external power receptacle.

ALWAYS test the external power receptacle (or electrical box) with a **Ground Monitor** BEFORE connecting your power cord.

**NEVER** connect the power cord if the ground monitor indicates reverse polarity or an open ground.

### WARNING

Use caution when using metal tools. If a tool makes contact with a battery terminal or the metal connected to it, a short circuit could occur which could cause personal injury, explosion or fire.

### WARNING

The power cord must be fully extended when in use and not left coiled in the electrical compartment or on the ground. If the power cord is left coiled, it may potentially create enough heat to melt its protective casing.



30 Amp Power Inlet



50 Amp Power Inlet

**WARNING**

- Do not hook up the power cord to any receptacle until you have verified proper polarity and grounding. Polarity indicators can be purchased in most electrical and hardware stores.
- Do not use any cheater plug, adapter or extension cord to reconfigure incoming AC power or break the continuity of the circuit connected to the grounding pin.
- Do not connect the power cord into an outlet that is not grounded, or adapt the power cord plug to connect it to a receptacle for which it is not designed.
- Do not remove the grounding pin to connect to a non-grounded receptacle. Removal of the ground pin disables an important safety feature designed to prevent electrocution and shock hazards.
- Do not connect the power cord to an extension cord. Use of an improper extension cord will cause overheating of the cord as well as potentially causing premature failure of the AC equipment.
- It is the responsibility of the electrical receptacle owner to ensure that it is properly wired and grounded.
- Reverse polarity and/or improper grounding of your RV can cause personal injury or death.

## 30-Amp or 50-Amp Power Cord, Continued

### Connecting the power cord

1. Turn OFF the load center main 120-volt circuit breaker.
2. Carefully extend the entire length of the power cord from the electric cable hatch to the external power source.
3. Plug the power cord into the receptacle. Make sure that all of the power cord prongs are properly seated into the receptacle.
4. Return to your RV and turn ON the load center main circuit breaker.
5. To help prevent power surges from damaging the connected loads, please follow these instructions when hooking up to the external power source:
  - a. Unplug the shore power cord when the RV is left unattended. This may help limit potential damage in the event of a power surge.
  - b. Use care to prevent damaging the connection pins when connecting or disconnecting the power cord.
  - c. Reverse the *Connecting the power cord* steps (1-5) listed above, when you are ready to leave.
6. ALWAYS disconnect the power cord from the outlet by the plug; NEVER disconnect the plug by pulling the cord.

### Power Cord Maintenance

Frequently inspect the power cord for cuts, cracks and worn insulation. Replace it immediately if any of these symptoms are found.

## 120-Volt AC System

Your RV is equipped with either a **30 amp** or a **50 amp** electrical system (select models). **It is important that you know which system is equipped on your RV.**

- The **30 amp** 120 volt 60hz AC electrical system is designed to operate on one (1) leg of 120-volt power at a maximum current flow of 30 amperes.
- The **50 amp** 120 volt 60hz AC electrical system is designed to operate on two (2) legs of 120-volt power at a maximum current flow of 50 amperes per leg.

Power to your 120-volt 60hz AC electrical system (30 amp or 50 amp) can be supplied by the 120-volt 60hz utilities found at RV campgrounds or by a generator. A campground's electrical service may occasionally experience high or low voltage.

- **Exposure to voltages higher or lower than 120-volts will damage or shorten the service life of the electrical system and appliances.**

The following electrical components (if so equipped) will operate **ONLY** when your RV is connected to shore power: 120-volt to 12-volt power converter, air conditioner, 120-volt refrigerator, microwave oven, television(s), fireplace, and other appliances that plug into convenience electrical receptacles.

*For recommendations on power-surge protection, Consult your dealer.*

## 120-Volt Circuit Breakers

The 120-volt AC circuit breakers are located in the main load center. They protect all of the 120-volt wiring and components. Each circuit is identified on a label inside the load center.

- An *overload* or *short circuit* will cause the breaker to *trip*, stopping the flow of electricity for the affected circuit.
- If a circuit breaker *trips*, turn OFF the appliance on that circuit. Allow some time for the circuit breaker to cool.
- **To RESET the circuit breaker**, flip the switch to the OFF position, then flip it back to the ON position.
- If a breaker immediately trips again or trips frequently, contact your dealer to diagnose and repair the problem.

### Maintenance and replacement

Circuit breaker switches can wear out. Test the breakers annually, at the beginning of the camping season. Replace them as needed, during normal maintenance.

- **To TEST:** Flip each breaker switch to the OFF position, then back to the ON position.

*For further information, Contact your dealer.*

### **WARNING**

*For 30 amp systems only:*  
Make certain the external power source you connect the power cord to is a **30-amp NEMA TT-30R RV receptacle** and not a 240 volt AC.

### **WARNING**

*For 50 amp systems only:*  
Make certain the external power source you connect the power cord to is a **50 amp NEMA 14-50 RV receptacle** and not a 240 volt AC.

### **WARNING**

Replacement circuit breakers must be of the same voltage, amperage rating and type. Never use a higher rated replacement circuit breaker; doing so may cause a fire by overheating the RV wiring.

### **CAUTION**

Circuit breakers and fuses will not offer complete protection of the electrical system in the event of a voltage spike/power surge

## Converter

The Power Converter changes 120-volt AC power to usable 12-volt DC power when the shore power cord is connected to an external power source. A thermal breaker is built-in to the converter to protect it from overheating.

Overheating is usually caused by the converter operating above its maximum power output for an extended time period, or too little air flow. To reduce converter heat, do not run any unnecessary 12-volt lights/motors/appliances and keep the converter cooling fins and fan clear of obstructions.

### Inspection and maintenance

If the 12-volt power converter is NOT working, or the auxiliary battery is not being charged:

1. Locate the converter fuse panel on one end of the converter.
2. Check the reverse polarity fuse or fuses.

The manufacturer's warranty will be void if the case has been removed. There are no customer serviceable parts inside.

*For further information, Contact your dealer.*

## GFCI Receptacle

Grounding is your personal protection from electrical shock. Each RV has a ground fault current interrupter (GFCI) engineered into the electrical system. This device has been designed to reduce the possible injury caused by electric shock. The GFCI will not protect against short circuits or circuit overloads.

- A *tripped* GFCI receptacle indicates that abnormally high 120-volt current flow (a ground fault) was detected through the electrical system grounding circuit.

A fault condition can be caused by faulty wire insulation, wet wiring inside an appliance, or faulty electrical equipment connected to the circuit, etc. All ground faults must be repaired before use of the RV.



## Test all GFCI receptacles monthly

- **Push in** the *TEST* button. This should **pop out** the *RESET* button, indicating the GFCI receptacle has been *tripped*. This will interrupt 120-volt power.
- **Push in** the *RESET* button. This should restore 120-volt power.

*Contact your dealer for assistance, if the RESET button does NOT restore 120-volt power or trips repeatedly.*

## 12-Volt DC System

Many of your RV components including the light fixtures, water pump, motors and appliances run on 12-volt electricity.

- The **Converter** supplies 12-volt power when your RV is connected to external power. The converter will also charge the Auxiliary Battery in most situations.
- The **Auxiliary Battery** supplies 12-volt power when your RV is NOT connected to external power.
- The **Tow Vehicle Alternator** supplies 12-volt power when the *7-Way Wire Harness* is connected, and the tow vehicle engine is running.

This runs the components needed for travel including, the brake lights, turn signals, brakes, running lights and the breakaway switch. In addition, the *7-Way Wire Harness* provides a common ground and a charge line to your auxiliary battery.

## 12-Volt DC Outlet (If So Equipped)

Your RV may include a 12-volt DC outlet (not applicable on all models). **ONLY** use this outlet for an appliance that runs on 12-volt DC power and consumes less than 60 watts (5 amps).

- **To prevent a short circuit, keep the 12-volt DC outlet free of any (metallic) foreign material.**

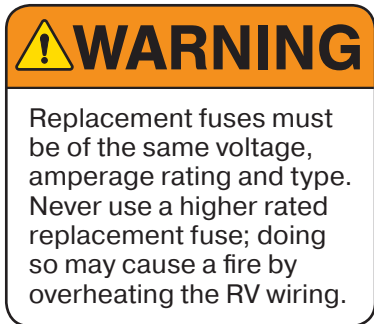

## 12-Volt Fuse Panel

The label inside the 12-volt fuse panel indicates the fuse sizes, positions and components powered. Annually, at the beginning of the camping season, inspect each 12-volt fuse and replace as needed.

### Replacing a fuse

Before replacing a fuse, always turn off the electrical component(s) protected by it.

1. Disconnect the shore power cord.
2. Disconnect the RV auxiliary battery main negative battery cable.
3. Remove the fuse panel cover to check fuses.
4. Pull the fuse straight out of the fuse block. If the fuse is not blown, something else must be causing the problem. Please contact your dealer for further assistance.
5. Insert a new fuse of the same specified voltage, amperage rating and type in the original location. Never use a higher rated replacement fuse.

The fuse panel label should be kept permanently affixed to your RV. The fuses will not offer complete protection of the RV electrical system in the event of a power surge or spike.

## Auxiliary Battery

Your RV has many 12-volt DC loads. When combined, their total is more than the converter can produce. High demands for 12-volt power can be met by an auxiliary battery for limited periods of time. The 12-volt DC electrical system is designed for usage with a Group 27, deep cycle battery.

### Dry camping

Consider the charge condition of the auxiliary battery when dry camping. If the auxiliary battery is not being recharged and power is being drawn, it will eventually discharge. A battery will discharge at a faster rate as its energy level becomes depleted. It is recommended you plan your electrical usage accordingly.

For accuracy, test the auxiliary battery voltage using a volt-ohm meter. A fully charged auxiliary battery will read 12.7 volts DC and 1.265 specific gravity at 80°F (32°C).

The auxiliary battery is considered discharged at 11.8 volts, and dead at 11.65 volts. When voltage drops below those levels, permanent damage may occur. Typically, a deep cycle battery has an amp-hour rating of 75-100 amps.

If the furnace and refrigerator are operating simultaneously, approximately (12.0 + 3.0) 15.0 amps per hour are used. This does not include any 12-volt lights, water pump or any other 12-volt component.

In the above example, if the furnace and refrigerator operated constantly, a 75 amp-hour battery would become fully discharged in 5 hours ( $75\text{ah} / 15\text{a} = 5\text{h}$ ).

The auxiliary battery should be installed in parallel with the battery in your tow vehicle. When the 7-way trailer plug is connected, both batteries power the RV so it is important not to discharge your tow vehicle battery below the level required to start the engine. To prevent this from occurring, disconnect the 7-way trailer plug or install a battery isolator. When the tow vehicle engine is operating with the RV connected, the tow vehicle charging system will charge both batteries.

### **Replacement and maintenance**

Even when turned OFF, some equipment in your RV will draw small amounts of current. To prevent the auxiliary battery from being discharged when your RV is not connected to shore line power, disconnect the auxiliary battery negative cable at the battery. During storage, it is important to check the voltage monthly and recharge the auxiliary battery as needed. If you remove the auxiliary battery from your RV, store it in a dry, cool area per the manufacturer's instructions.

When it is time to replace the auxiliary battery, replace it with a Group 27 deep cycle battery only. Contact the battery manufacturer for further information. Do not reverse the positive and negative battery cables (doing so will blow the reverse polarity fuse(s) that protect the converter).

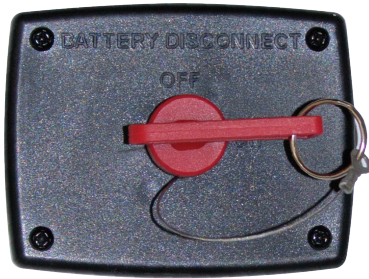

Battery Disconnect Switch

## Battery Disconnect Switch

The *Battery Disconnect Switch* (see photo) is located in the large, front pass-thru compartment. When the RV is in storage or auxiliary power will not be needed:

- Shut OFF the Battery Disconnect Switch, *and*
- Disconnect the battery cables from the auxiliary battery terminals.

Remember to reconnect the battery cables and turn ON the battery disconnect switch when you are ready to use the RV or perform periodic maintenance checkups.

## Calculating Electrical Load

While connected to external power and using appliances, remember that the 120-volt electrical system can run a *maximum* of 100 amps. If you overload the RV and/or camp-ground electrical system, a circuit breaker *trip* may occur.

- **Added together, the amperage of each appliance and component running at the same time, must NOT exceed 100 amps.**

To calculate the amperage rating for each individual appliance, divide the *wattage* by the *voltage* (both should be listed on the appliance). For example: **1200 watts** *divided by* **120-volts** equals **10 amps**.

See the **Next Page**, *Approximate Electrical Load Ratings*.



Solar Port

## Solar Port (If So Equipped)

The Furrion quick connect solar charging inlet is designed for use with the (customer supplied) Furrion 95W portable solar power charging system (FSPP10SA-BL).

## Replacing Light Bulbs (Customer Supplied)

- BEFORE replacing a bulb, turn OFF the light switch.
- Check that your replacement bulbs are the type, wattage and voltage listed on the lamp fixture.

**Using the wrong bulb can overload the lamp circuit and overheat the fixture, creating a fire hazard.**

## Approximate Electrical Load Ratings

Use the actual amperage of the appliance when possible.  
(Watts ÷ 120)

120 Volt System	
Air Conditioner	18 amps
Coffee Maker	6-12 amps
Converter (Each)	8 amps
Curling Iron or Hair Dryer	10-14 amps
Blu-Ray/DVD System	3 amps
Microwave	12 amps
Refrigerator	6 amps
Satellite Receiver	2 amps
TV	2-4 amps
Vacuum Cleaner	8 amps
Washer / Dryer	12 amps
Water Heater	12 amps

12 Volt System	
Aisle Lights	1.0 amps
Baggage Compartment Lights	1.4 amps
Decorative Wall Lights	1.5 amps
Dinette Light	4.5 amps
Exterior Entertainment Center	5-7 amps
Fantastic Fan	1.5 amps
Fluorescent Double Lights - 12"	2.0 amps
Fluorescent Double Lights - 18"	2.5 amps
Furnace	12.0 amps
Generator Start	95.0 amps *
Halogen Light	1.7 amps
Illuminated Switch	.125 amps
Inverter	<i>Variable</i>
Leveling System	95.0 amps *
LP Detector	.125 amps
Map Light	1.5 amps
Porch Light	1.5 amps
Power Awning	10.0 amps
Power Vent	5.0 amps
Refrigerator	3.0 amps
Shower Light	1.4 amps
Step Cover	10.0 amps
TV Plate / Antenna Booster	1.0 amps
Vanity Light	4.2 amps
Water Heater	6.0 amps
Water Pump	7.0 amps
* Momentary load	

This page is intentionally blank.

# Plumbing Systems

There are two separate water systems in your RV, the *Fresh Water System* and the *Waste Water System*.

- The **Fresh Water System** consists of the fresh water holding tank, fresh water connections, water pump, water heater, faucets, shower or tub, water purification system (if so equipped) and outside shower assembly (if so equipped).
- The **Waste Water System** consists of the waste water holding tank, drains, toilet and sewage holding tank.

BEFORE each trip or vehicle storage, and as part of normal maintenance, inspect the following for leaks:

- ALL fittings on BOTH water systems.
- ALL faucet and sink connections (including drain baskets or filters).
- ALL water pump and water heater connections.

**At the end of each trip, ALWAYS completely drain your fresh water system.**

## Fresh Water System - First Use

Your new RV may have been winterized, as indicated by temporary labels located in the universal docking station.

- BEFORE first use, the system should be **Sanitized**, even if it has NOT been **Winterized**.
- Sanitizing the fresh water system will kill all bacteria and organisms that can contaminate your water supply.

Small amounts of contaminants and minerals are found in ALL water. They can sometimes cause your fresh water to have an odor. Usually, untreated well water is the source of water system odors.

See **Page 101**, *Sanitizing the Fresh Water System*.

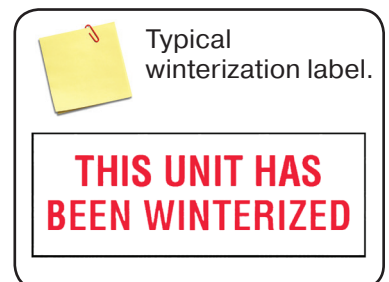
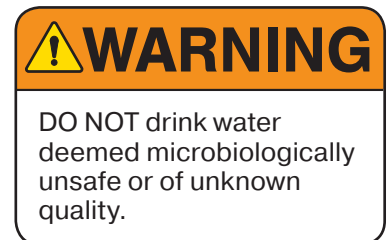

## Monitor Panel

The monitor panel is found on the interior, wall-mounted Command Center. It displays the levels of fresh water, grey water, black water and the voltage of your auxiliary battery. Sensors installed in the holding tanks relay the tank level to the display board. These functions are controlled using the labeled buttons on the monitor panel faceplate.

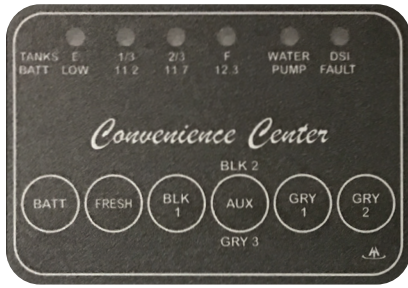

Monitor Panel

The monitor panel operates on 12-volt DC power supplied by either the converter or auxiliary battery. No power is drawn from the battery unless a button is pushed. Fuses for the monitor panel are located in the load center.

### Operation

Press only one button at a time.

- When the *FRESH*, *BLK*, *GRY1* or *GRY2* button is pressed, the LED lights display the fill level of the selected holding tank.
- When the *BATT* button is pressed, the LED lights display the approximate voltage of your auxiliary battery.



Command Center

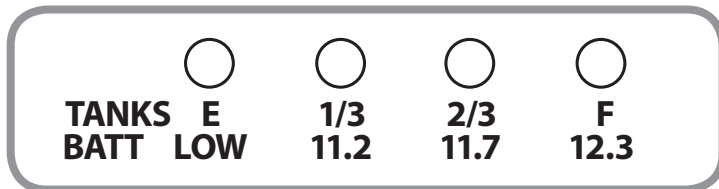

Water Pump & Water Heater On/Off Switches

### Water pump switch

When the water pump switch is turned ON, the water pump runs until 45 pounds of pressure has been achieved. Turn the water pump switch OFF when it is not in use.

*The Water Pump switches illuminate, when in the ON position.*

### Water heater switch

The GAS water heater switch enables propane operation of the water heater. The ELECTRIC water heater switch enables electric operation of the water heater.



## 12-Volt Water Pump

Once activated, the water pump (*or on-demand pump*) will self-prime, and provide water. The water pump continues to run until approximately 45 lbs. of pressure is achieved and shut off. The water pump will automatically restart when pressure drops. Some cycling may occur, depending on the volume of water being released. The water pump has a built-in check valve to prevent water from back flowing.

**Water pump filter (if so equipped)** is a screen filter located on the inlet side. This reusable screen must be cleaned periodically.

## Fresh Water Holding Tank

The fresh water tank can be pressure filled using the fresh water inlet (called city water). Plastic overflow tubes are plumbed into the fresh water holding tank to allow water to flow out of the water tank. Occasionally, you may see water coming from the overflow tubes (located underneath the RV) when the fresh water holding tank is filled. This is normal, and is caused by external circumstances, including the RV being parked on an incline, or the motion caused by starting or stopping the RV during travel.

DO NOT cap, block or modify the fresh water tank overflow tubes in any way. If the overflow tubes are obstructed, enough water pressure can build up during the filling process to damage the plumbing system.

## Water Pressure Regulator (Customer Supplied)

Excessive pressure from water supply systems may be encountered in some parks, especially in mountain regions. Water pressure regulators can protect your system against such high pressure. Water pressure regulators are available for purchase from your RV dealer to protect the plumbing system against such high pressure.

### NOTICE

Be careful not to overfill the fresh water holding tank. It can pressurize the tank, causing leakage and water damage and void the warranty. DO NOT leave the tank unattended while filling.

### NOTICE

The fresh water connection should be unplugged (i.e. the non-toxic drinking water hose disconnected) when the RV is left unattended for any amount of time. If something would happen to the water system, this may help limit water damage to a smaller area.

### NOTICE

Not using a water pressure regulator when using city water may cause the o-rings to fail. To prevent damage to the plumbing system or components when using the city water connection, a water pressure regulator rated for 40 lbs. is recommended.

**! WARNING**

If you smell propane gas then **STOP!** Follow the procedures listed in the Propane System section of this manual before attempting to operate the water heater.

**! WARNING**

Hydrogen gas may result if you have not used the water heater for two weeks or more. **HYDROGEN GAS IS EXTREMELY FLAMMABLE.** To reduce the risk of injury under these conditions, open the hot water faucet for several minutes at the kitchen sink before you use any electrical appliance connected to the hot water system. If hydrogen is present, you may hear what sounds like air escaping through the pipe as the water begins to flow. Hydrogen gas may be present even after water has been drained from the water heater tank. Open the faucet at the sink and allow the system to vent for five to ten minutes. Do not smoke or have any open flame near the open faucet while venting. On DSI water heater models, make sure the switch is OFF.

## Water Heater

The water heater is designed to heat water quickly and efficiently. The water heater manufacturer has preset the sensing limit to maintain the water temperature when the water heater is activated. Read the safety and operating information provided in the manufacturer’s manual before attempting to activate the water heater.

### Operating instructions

Make sure the water heater is filled with water before use; even momentary operation of the water heater without water in it may result in damage to the tank and/or controls. Always open both the hot and cold water faucets when filling the fresh water tank to allow air pockets to be forced out of the water heater.

### Draining and winterization

If the RV is to be stored over the winter months, the water heater must be drained to prevent damage from freezing. It is recommended the water heater be drained and bypassed during the winterization process particularly if introducing RV antifreeze into the plumbing system.

### Odor from the hot water system

Many water sources provide running water with a *rotten egg* smell. Often called sulfur water, it contains hydrogen sulfide gas caused by bacteria or chemical action. Generally, sulfur water is not harmful, only unpleasant to smell. Sulfur water odor is not a service problem.

See **Page 185**, *Basic Troubleshooting, Water Heater*. Also refer to the water heater manufacturer's owner manual for details on eliminating the odor from sulfur water

Pressure and Temperature Relief Valve

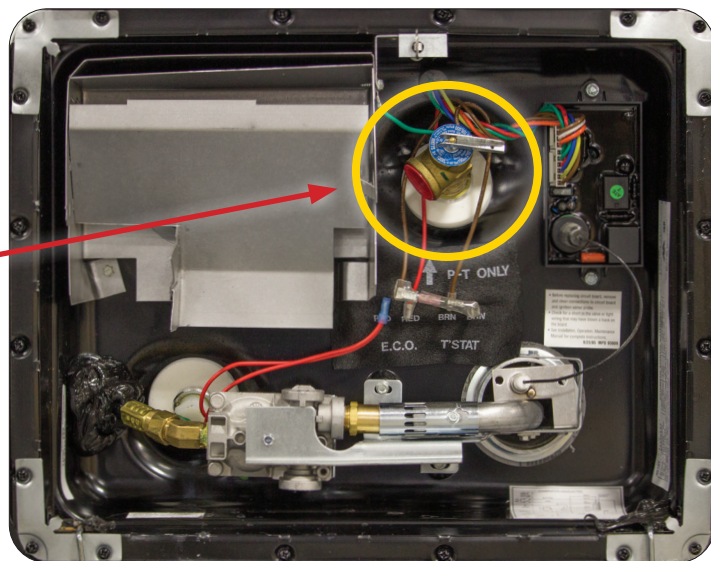

Exterior Water Heater Door

## High altitude deration

Operation of the water heater at high altitudes may require derating. If the water heater is not properly derated, lack of sufficient oxygen for combustion may produce improper burner operation. Pilot outage caused by burner lift-off or sooting from a yellow burner may occur, indicating the possibility of carbon monoxide. You may also notice a lack of efficiency in heating the water because of incomplete combustion of the burner at these higher altitudes.

Consult with a local propane company, your dealer or the water heater manufacturer for proper derating of the water heater. Change out of the orifice (derating) should be done by the dealer or a qualified service agency.

**Important Note:** Once the RV is returned to lower elevation (below 4500 feet) any high altitude deration or other the water heater adjustments must be reversed for proper operation.

## Pressure and temperature relief valve

A pressure and temperature (P & T) relief valve is a safety requirement for all water heaters. This valve releases any unsafe pressure in the water heater tank created as cold water is heated. It is normal for the P & T relief valve to release a small quantity of water during the heating cycle.

One way to reduce water dripping from the P & T relief valve is to maintain an air pocket at the top of the water heater. This air pocket will form in the tank by design; however, it will be reduced over time by the everyday use of your water heater (refer to the manufacturer's manual); If the weeping persists, consult your dealer or a service agency authorized by the water heater manufacturer.

See **photo** on facing page.

### **WARNING**

Water temperatures over 125°F (49°C) can cause severe burns instantly or death from scalds; therefore, be careful when using hot water. Always test the water temperature before showering or washing.

### **WARNING**

Do not replace any component part with an accessory part that is not authorized by the water heater manufacturer, such as an "add-on" electric heating element. Such items are not approved to be installed and could create an unsafe condition and will void all warranties.

## Bathroom Shower

Unlike your home, the RV does not contain a water pressure balance valve. When the shower is in use, DO NOT run any other water until shower is finished. Air may need to be bled out of the plumbing lines before a steady stream of water flows.

1. Keep aware of the water heater and holding tank capacities. All water used, will drain through the plumbing lines into the grey water holding tank.
2. Be sure the water heater is ON and has had sufficient time to heat the water.
3. If dry camping, be sure the 12-volt water pump is ON.
4. Turn ON the hot and cold knobs, and adjust the water temperature *before* showering.
5. To conserve water while showering, wet down and turn OFF the water while using soap, then rinse.
6. When shower is finished, shut OFF the hot and cold knobs.

There is no shut-off valve for the showerhead; shut-off is at the hot and cold knobs only. After use, the showerhead may still drip slightly, even in the OFF position. This is normal and does not indicate a leak or defect.

### Maintenance

Read the manufacturer's operator manual. The shower walls in your RV are plastic. Use a mild detergent soap and warm water to clean. NEVER use gritty or abrasive particle soaps or scouring compounds to clean the plastic.

## Outside Shower

A handheld shower assembly with both hot and cold water is available for washing or rinsing outside the RV at the utility center.

1. Be sure the water heater is ON and has sufficient time to heat the water.
2. If dry camping, be sure the 12-volt water pump is ON.
3. Remove the handheld showerhead and hose from its holder.
4. Turn ON the hot and cold knobs, and adjust the water temperature as desired.
5. To activate the hand held shower turn ON the sprayer head attachment (if so equipped).

To cease operation, shut OFF the hot and cold knobs. After the water has been allowed to drain from the sprayer head, replace it in the utility center. Any remaining water in the shower hose will drip or run out; this is not a leak but performs as intended. Make sure that the hose is not pinched and the sprayer head is not damaged when the compartment door is closed.

## Faucets

The faucets inside your RV operate much the same way as the faucets in your home. Make sure there is sufficient water available and, if dry camping, the 12-volt water pump is turned ON before operating. To open the faucets, turn the hot and cold knobs ON and adjust the temperature to your comfort level. Close the faucets when a sufficient amount of water is released.

## Water Control System

Your Reflection Fifth Wheel is equipped with a Nautilus Water Control System. Most use the Nautilus P1. The Reflection 150-Series uses the Nautilus P2. To understand operation of your water control system, please refer to the user instructions included in this manual:

- Nautilus P1 - **Page 109**
- Nautilus P2 - **Page 125**

### Draining and winterizing

If the RV is to be stored over the winter months, the water heater must be drained to prevent damage from freezing. The water heater should also be drained and bypassed during the winterizing process particularly if introducing RV antifreeze into the plumbing system.

### Draining the Fresh Water System

The low-point drains valves release water in the supply lines by opening the valves and all faucets. The water heater has its own drain plug. To drain the permanent fresh water holding tank and supply lines:

1. Open all faucets, including the outside shower.
2. Open the white fresh water holding tank gate valve.
3. Open red and blue low point drain lines extending through the underbelly.
4. Drain the sink by removing the drain cap.
5. Turn ON the water pump and allow it to run as needed.
6. Set the *water heater bypass valve* to **Normal** (horizontal).
7. ALWAYS use the water heater **P & T Valve** (*pressure and temperature valve*) to relieve the water pressure, BEFORE you remove the water heater drain plug.  
If you do not relieve the water pressure, water will spray out of the opening when the drain plug is removed.  
*See Photo, on Page 96*
8. Remove the water heater drain plug.

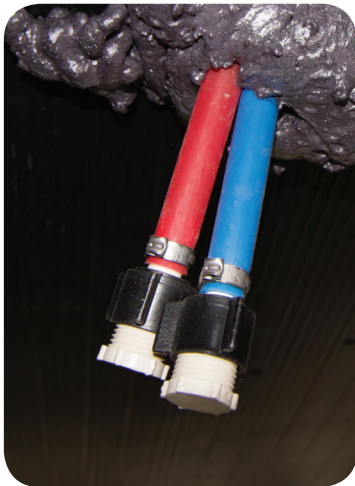

*Low-Point Drains located under the RV*

After draining the fresh water system, reverse these steps. Next, dump the grey and black water holding tanks at an appropriate facility according to local public codes. It is normal for some liquid to remain in the fresh water tank after drainage procedure.

## Sanitizing the Fresh Water System

Use the following procedures to sanitize your Fresh Water System (*or Potable Water System*) when it is new, becomes contaminated, or has not been used for a period of time.

- Prepare a chlorine solution using one (1) gallon of water and one-quarter (1/4) cup of household bleach (5% sodium hypochlorite solution).
- Prepare approximately one (1) gallon of solution for every fifteen (15) gallons of holding tank capacity.

Note: as an option, several commercial solutions are available, and should be used as directed on the package.

### To sanitize the fresh water tank & fresh water system:

1. Level the RV.
2. Open the fresh water system gate valve and drain out any water in the tank. Close the valve when drained.
3. Make sure the low point drain valves are closed.
4. Please refer to **Page 114**, *Nautilus P1 Manual*, for detailed procedures and specific valve positions.
5. Connect a garden hose, *not your potable water hose*, to the winterization fill, place the other end in the container of chlorine solution.
6. Turn on the water pump to until the container containing the chlorine solution is empty.
7. Complete filling the tank with fresh water.
8. Operate all faucets to release trapped air, *then* Turn OFF the pump.
9. Allow solution to stand for three (3) hours.
10. DRAIN tank and FLUSH the system with fresh water.

### To remove excessive chlorine odor or taste which may remain:

11. Prepare a solution of one (1) quart vinegar to five (5) gallons water and **repeat steps 3-10** above.
  - **At step 5**, place the hose in the container of vinegar solution. Allow solution to agitate in tank by intermittent vehicle motion (several days if possible).
12. Drain tank and flush with fresh potable water.

## **WARNING**

Both automotive antifreeze (ethylene glycol) and windshield washer anti-freeze (methanol) are poisonous.

NEVER use these products in your fresh water system. They are harmful and may be fatal if swallowed.



It is important to read all instructions & understand each step before beginning the winterization process. It may be easier to winterize the RV with another person to assist you. If needed, contact your dealer for assistance.

## Winterizing the Plumbing System

Preparing your RV for colder weather or storage is very important for most states and Canada. Failure to prepare your RV may cause water supply lines and the water heater to freeze. No commodity or product should be added to the fresh water system to ensure freeze protection other than RV antifreeze. The RV should be winterized at the end of the camping season or when the RV will be exposed to temperatures that will fall at or below 32°F (0°C). Repairs due to freezing are not covered under warranty.

1. Level the RV and drain the fresh water plumbing system.
2. Make sure the water heater 12-volt and 120-volt interior control switches are OFF.
3. Please refer to **page 118** (Nautilus P1 manual) and **page 132** (Nautilus P2 manual) for detailed instructions on specific valve positions procedures at the outside utility center.
4. OPEN the *fresh tank drain*, and CLOSE both *low point drains*.

*Make sure to have enough RV antifreeze to winterize all fresh water lines. Several gallons may be required.*

5. Insert the garden hose into a container of RV antifreeze solution attach the other end to the winterization fill.
6. Turn the water pump ON.
7. Open the hot water line on all the faucets (lavatory, inside and outside showers, kitchen,) until RV antifreeze begins to flow continuously.
8. Close the faucet hot water lines and repeat with the cold water lines on all the faucets. Do not forget to run RV antifreeze through the toilet, sink and shower drains.

### **When you are done adding RV antifreeze**

9. Be sure to blow out (with compressed air - max 70 PSI) the black tank flush line at the outside connection. An alternative is to pump antifreeze in this dedicated line.
10. To prevent staining, wipe the RV antifreeze out of the sinks, shower (or tub), sink and toilet using a soft, dry cloth.



## Black/Grey Water System

The sinks and shower drain into the grey water (waste water) holding tank. The toilet drains into the black water (sewage) holding tank.

- ALWAYS empty the grey and black water holding tanks before traveling to avoid carrying unnecessary weight.
- If you are dry camping and cannot immediately empty your holding tanks, reduce your vehicle speed until you reach a dumping station.

The RV's cargo carrying capacity is based on *empty* holding tanks. Any additional weight for the *contents* of the holding tank(s) will reduce your cargo carrying capacity by the same amount.

### Traveling with your holding tank(s) full could result in the following dangers:

- Reduced available cargo capacity.
- Exceeding individual tire ratings and/or the GAWR or GVWR.
- Potential damage to suspension components, such as springs, tires and axles.
- Reduced hitch weight, if your RV holding tank(s) are located behind the axles.
- Trailer sway and other handling difficulties, as a result of the hitch weight being too light.

Driving to a disposal site will normally loosen any accumulated waste debris or solids from the sides of the holding tanks.

BEFORE using the RV or after dumping the grey and black water holding tanks, ALWAYS add the proper amount of deodorant to the black water tank (unless winterizing). This will help to control odor and break down tank contents. Follow instructions on the deodorant bottle or package.

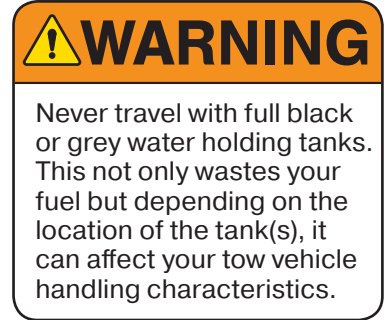

## Toilet

Your RV toilet is both efficient and easy to operate.

- BEFORE use: FLUSH the toilet several times, releasing enough water to cover the bottom of the holding tank.
- ALWAYS maintain four to six inches (10-15 cm) of water in the toilet for better sanitation system performance.

**To help prevent a toilet blockage:** ALWAYS use RV grade, single-ply toilet paper. NEVER flush paper towels, diapers, sanitary napkins or any foreign objects down the RV toilet.

**NOT using enough water while flushing, could result in clogged pipes or tanks.** The average recreation vehicle toilet uses only one to three quarts (1-3 liters) of water per flush, about ten times less than a toilet in a home. The toilet system will perform better when water is run for an additional ten to fifteen seconds *after* flushing. More water may be needed to thoroughly flush solids and ensure that waste materials empty from the drain line into the tank.

### Sewage (black) tank preparation

1. Release one to two quarts (1 or 2 liters) of water into the toilet bowl.
2. Pour the recommended quantity of holding tank chemical (customer supplied) into the toilet bowl, per the manufacturer's directions.
3. Flush the toilet and allow at least two gallons (8 liters) of water to flow into the holding tank.

### Waste (grey) holding tank preparation

No special preparation is required, however, placing a small quantity of chemicals into this tank, such as baking soda or an approved RV chemical, will reduce odors from food particles in the system.

### Cleaning and maintenance

Clean the toilet regularly. DO NOT use chlorine (undiluted) or caustic chemicals in the toilet system (ie., laundry bleach or drain opening chemicals). These products damage the seals in toilets and dump valves. For a *sticky* toilet ball valve, apply petroleum jelly; this will provide waterproof lubrication without damaging the seals.

## Drain Pipes With Dry Sealing Valve

Your RV may be equipped with a dry sealing valve that prevents the escape of odors from your waste system and eliminates the need for P-traps. Should the RV drain piping system become clogged and a mechanical clean-out tool is used to open the drain pipe, it is important that the dry valve be removed before passing the clean-out tool through the piping. Passing a mechanical clean-out tool through the waterless valve may cause damage to the internal seal that may potentially allow sewer gases to escape to the RV interior.

## Drain Pipes With P-Traps

The drain pipes may be equipped with a *P-trap* installed to help prevent odors from escaping into the RV. During travel, water from the P-traps may spill and permit odors into the RV. By adding water and using a RV approved deodorizing agent you will dissolve the contents faster and will keep the drain lines and tanks clean and free flowing. These chemicals are available at an RV supply store or your dealer.

## Vents & Vent Pipes

Another important part of this system is the vent pipes and vents that release air from the grey and black water holding tanks. The exterior vent cap is attached to the roof and must be kept clear of obstructions to perform as intended. On some models, the vent pipe may be part of the drainage system referred to as a *wet vent* (water flows downward as air flows upward in the same pipe).

## Black/Grey Water Holding Tanks

When connected to the sewer drain line at a campground, keep the *black tank drain* valve closed until the holding tank is at least  $\frac{3}{4}$  full. This should provide sufficient water to assist in complete draining of the black water holding tank. Repeat as needed. Never leave the black tank drain in the open position continuously when connected to the campground sewer system.

 **WARNING**

Do not add automotive antifreeze or caustic chemicals such as laundry detergents into the holding tanks. Although these products may have a deodorizing effect, they may damage the plastic and rubber parts of the plumbing system or the components.

## Emptying the Black & Grey Water Tanks

The two grey tank drain valves and one black tank drain valve (also called dump valves) are located in the outside utility center and/or below the skirt metal on the street side of your RV. Always drain the black water holding tank first so the following grey tank waste water can help rinse any solids or debris from the dump outlet and sewer hose.

1. To make drainage easier, level the RV.
2. Locate the *Sewer Outlet Connection* and remove the sewer hose housing dust cap, and attach your sewer hose (customer supplied).
3. Place the other end of the sewer hose into the approved dump station.
4. Open the black tank dump valve by carefully pulling it out towards you (close it by pushing it shut when the black water holding tank is emptied).
5. Similarly, open each grey tank dump valve (one at a time) and close it after each grey holding tank is emptied).
6. Remove, clean and store the sewer hose.
7. Close the sewer hose housing dust cap.

### NOTICE

It is important to prevent solid waste buildup. Follow the toilet manufacturer's recommended instructions each time the black water holding tank is emptied.



Sewer cap must be securely in place while the vehicle is in motion.

You can locate many dump stations throughout the United States and Canada in Woodall's, Rand McNally Camp Guide, Good Sam Camp Guide, KOA Kampgrounds Camp Guide and various other publications. Some fuel stations also have dump stations. Please contact your dealer for assistance in the purchase and installation of a sewer hose or sewer hose extension (if needed).



*Sewer Outlet Connections are Located on the Off-Door Side*

## Black Tank Flusher

The black tank flusher is designed to rinse the interior of the black (waste) tank. A separate water hookup is located in the docking station. Also See **Page 122**, *Nautilus P1 Manual* or **Page 134**, *Nautilus P2 Manual*

To flush the tank after dumping:

1. Leave the sewer hose connected to the outlet pipe. Ensure that it is routed to the dump station inlet.
2. Attach a garden hose to the *black tank flusher inlet*. **DO NOT use your fresh water hose.**
3. Be sure the black tank gate valve is in the OPEN position.
4. Open the water supply to full pressure to flush tank.
5. When the water runs clear from the sewer hose, shut off the water supply and disconnect the garden hose from the water source.
6. Do not disconnect hose from flush inlet until all water has drained from the system.

**DO NOT add any check valves to this system or leave any hose connected when not in use.**

### NOTICE

When flushing the black tank, the gate valve must be open or damage may occur to the system.



*The Nautilus P1 or P2 System Is Located in the Forward, Pass-Thru Storage on the Off-Door Side.*

Black Tank Flusher  
or Tank Flush Inlet

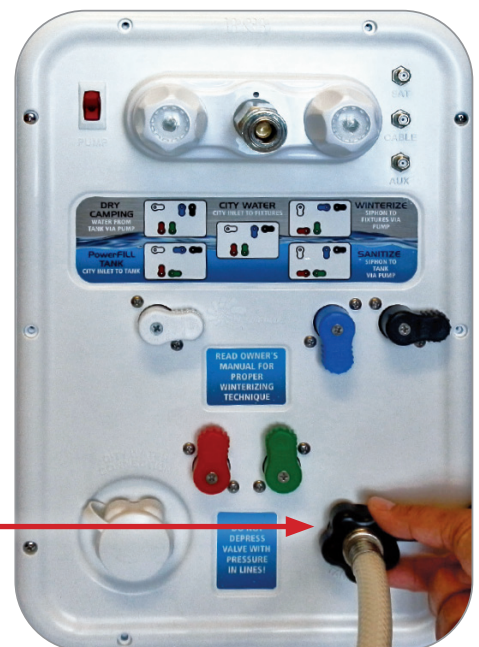

*The Nautilus P1 System*

This page is intentionally blank.

# Nautilus P1 Manual



## USER INSTRUCTIONS



[www.bandbmolders.com](http://www.bandbmolders.com)

58471 Fir Road  
Mishawaka, IN 46544  
Phone: 574-259-7838  
Fax: 574-259-7939



## USER INSTRUCTIONS

**Congratulations on purchasing an RV equipped with the most advanced water management system available today! Be sure to read all *Caution* and *User Instructions* on the Nautilus Panel and in your Owner's Manual before performing any operation using the Nautilus Panel System.**

**NEVER depress check valve on "CITY WATER CONNECTION" with pressure in the line. It will cause irreparable damage to the check valve function.**



58471 Fir Road, Mishawaka, IN 46544  
Phone: (574) 259-7838 Fax: (574) 259-7939  
[www.bandbmolders.com](http://www.bandbmolders.com)





## USER INSTRUCTIONS

**The Nautilus P1 Panel System will allow you to perform the following functions:**

1. Power fill your fresh water tank for remote or dry camping
2. Use your pump to supply water to fixtures from fresh water tank
3. Use your pump to siphon fill or sanitize your fresh water tank from a bucket
4. Connect to city water at the camping site to supply water to fixtures
5. Winterize your plumbing lines and fixtures
6. Bypass hot water heater when winterizing to avoid water heater damage
7. Rinse black tank to help control odors and prevent sewage buildup
8. Rinse off items outside unit with a hot/cold faucet
9. Connect up to three (3) coax lines with satellite, cable and auxiliary



58471 Fir Road, Mishawaka, IN 46544  
Phone: (574) 259-7838 Fax: (574) 259-7939  
[www.bandbmolders.com](http://www.bandbmolders.com)



## USER INSTRUCTIONS

### CONNECTING COAX FOR CABLE AND/OR SATELLITE



1. For cable TV connection, connect the threaded coax from the source to the **"CABLE"** connection.
2. For satellite TV connection, connect the threaded coax from the satellite dish to the **"SAT"** connection.
3. Consult your Owner's Manual to see if the **"AUX"** connection has an application.



58471 Fir Road, Mishawaka, IN 46544  
Phone: (574) 259-7838 Fax: (574) 259-7939  
[www.bandbmolders.com](http://www.bandbmolders.com)



## USER INSTRUCTIONS

### Power Filling Fresh Water Tank "PowerFILL TANK"

1. Connect garden hose to inlet labeled "CITY WATER CONNECTION."
2. **BLACK** diverter handle should be facing right as shown.
3. **BLUE** diverter handle should be facing left as shown.
4. **WHITE** diverter handle should be facing right as shown.
5. **RED** diverter handle should be facing up as shown.
6. **GREEN** diverter handle should be facing right as shown



7. Turn water on. Fresh water tank should begin to fill.



8. Consult your Owner's Manual for tank capacity. **DO NOT OVERFILL TANK!**

9. When water has reached desired level in tank, turn water off at source.



10. Disconnect garden hose at source before disconnecting from Nautilus panel.





## USER INSTRUCTIONS

### Siphon Fill or Sanitize Fresh Water Tank via Pump "SANITIZE"

1. Connect garden hose to inlet labeled "CITY WATER CONNECTION."
2. **BLACK** diverter handle should be facing right as shown.
3. **BLUE** diverter handle should be facing down as shown.
4. **WHITE** diverter handle should be facing down as shown.
5. **RED** diverter handle should be facing left as shown.
6. **GREEN** diverter handle should be facing right as shown.



7. Place other end of hose in container holding water or sanitizing solution.



8. Push "PUMP" switch so that the light on switch is lit.





## Siphon Fill or Sanitize Fresh Water Tank via Pump "SANITIZE"

9. Pump should be running and fresh water tank should begin to fill.
10. Consult your Owner's Manual for tank capacity. **DO NOT OVERFILL TANK!**
11. When desired level in fresh water tank is reached, turn pump off by pushing "**PUMP**" switch so that it is not lit.

12. Disconnect garden hose from inlet on Nautilus panel.





## USER INSTRUCTIONS

### Using Pump to Supply Water from Fresh Tank "DRY CAMPING"

1. Make sure fresh water tank has necessary supply of water.
2. **BLACK** diverter handle should be facing down as shown.
3. **BLUE** diverter handle should be facing down as shown.
4. **WHITE** diverter handle should be facing right as shown.
5. **RED** diverter handle should be facing up as shown.
6. **GREEN** diverter handle should be facing up as shown.
7. Push "**PUMP**" switch so that the light on switch is lit. Select pump switch located on inside of unit or on Nautilus Panel.
8. Pump should now run and water should be available to all fixtures.
9. Make sure pump is turned off when not in use.



58471 Fir Road, Mishawaka, IN 46544  
Phone: (574) 259-7838 Fax: (574) 259-7939  
[www.bandbmolders.com](http://www.bandbmolders.com)



## USER INSTRUCTIONS

### Using System from Pressurized Water Source "CITY WATER"

1. Connect garden hose to inlet "CITY WATER CONNECTION."
2. **BLACK** diverter handle should be facing right as shown.
3. **BLUE** diverter handle should be facing down as shown.
4. **WHITE** diverter handle should be facing right as shown.
5. **RED** diverter handle should be facing up as shown.
6. **GREEN** diverter handle should be facing up as shown.



7. Turn "on" water at the source. Water should be available to all fixtures.



58471 Fir Road, Mishawaka, IN 46544  
 Phone: (574) 259-7838 Fax: (574) 259-7939  
[www.bandbmolders.com](http://www.bandbmolders.com)



## USER INSTRUCTIONS

### Winterizing Plumbing Lines and Fixtures "WINTERIZE"

1. Turn handles to "POWERFILL" position as shown.

**BLACK** diverter handle should be facing right.

**BLUE** diverter handle should be facing left.

**WHITE** diverter handle should be facing right.

**RED** diverter handle should be facing up.

**GREEN** diverter handle should be facing right.



2. Open low point drain on RV to remove water in plumbing lines. Open both a hot and cold faucet to help drainage process.

3. Open drain plug on hot water heater to drain water if unit is equipped with hot water holding tank.

(Contact your dealer or manufacturer for exact location of low point drain hot water heater.)

4. Once most water has been drained from plumbing lines, turn **RED**, **BLUE**, **GREEN** and **WHITE** handles so they are at a 45 degree angle as shown.



58471 Fir Road, Mishawaka, IN 46544  
Phone: (574) 259-7838 Fax: (574) 259-7939  
[www.bandbmolders.com](http://www.bandbmolders.com)





## USER INSTRUCTIONS

### Winterizing Plumbing Lines and Fixtures "WINTERIZE"

- Using "**CITY WATER**" inlet or low point drain, blow out plumbing lines (40 PSI max) with handles still at 45 degree angle as shown. This will ensure any trapped water in plumbing harness is removed.

- Close low point drain & hot water heater drain.



- Turn handles to "**WINTERIZE**" position.

**BLACK** diverter handle should be facing right as shown.

**BLUE** diverter handle should be facing left as shown.

**WHITE** diverter handle should be facing down as shown.

**RED** diverter handle should be facing left as shown.

**GREEN** diverter handle should be facing up as shown.

- Connect a short section of garden hose to inlet labeled "**CITY WATER CONNECTION.**"



58471 Fir Road, Mishawaka, IN 46544  
 Phone: (574) 259-7838 Fax: (574) 259-7939  
[www.bandbmolders.com](http://www.bandbmolders.com)



## USER INSTRUCTIONS

### Winterizing Plumbing Lines and Fixtures "WINTERIZE"

9. Place other end of garden hose in container holding approved winterizing solution.



Note: A short or cut off section of garden hose should help the pump to prime easier.

10. Push "PUMP" switch so that light on switch is lit.



11. Pump should be running and winterizing solution should begin to flow through pump into plumbing lines and fixtures. (The pump will run when a plumbing fixture is open.)
12. Open one plumbing fixture, keeping it open until winterizing solution appears, then close.
13. Follow above procedure until all inside and outside plumbing fixtures have been winterized.

**Important!** Make sure to run winterizing solution through hot & cold lines on exterior shower.

14. Turn **BLUE**, **GREEN** and **WHITE** handles so they are at a 45 degree angle for 10 seconds as shown.



15. Push "PUMP" switch so that light on switch is not lit



58471 Fir Road, Mishawaka, IN 46544  
Phone: (574) 259-7838 Fax: (574) 259-7939  
[www.bandbmolders.com](http://www.bandbmolders.com)



## USER INSTRUCTIONS

### Winterizing Plumbing Lines and Fixtures "WINTERIZE"

16. Return **BLUE**, **GREEN** and **WHITE** handles to "WINTERIZE" position as shown.



17. Disconnect garden hose from "CITY WATER CONNECTION" inlet.



It is normal for some winterizing solution to exit inlet as hose is being disconnected.





## USER INSTRUCTIONS

### Rinsing the Waste Tank "TANK FLUSH"

1. Connect flexible sewer hose to 4" dump outlet.



2. Open black waste holding tank valve and leave open. Allow tank to drain.



3. Attach a garden hose to inlet labeled "TANK FLUSH."



4. Fully open faucet at water supply source (40 psi minimum) flushing tank until water appears clear in 4" discharge hose.





## USER INSTRUCTIONS

### Rinsing the Waste Tank "TANK FLUSH"

5. Completely close faucet at water supply source.



6. Disconnect garden hose from water supply source.



7. Disconnect garden hose from "TANK FLUSH" inlet.



8. Close black waste holding tank valve.



**NOTE:** To help keep debris from clogging tank sprayer orifices, use the **Tank Flusher** every time waste holding tank is emptied.



This page is intentionally blank.

# Nautilus P2 Manual



## USER INSTRUCTIONS



[www.bandbmolders.com](http://www.bandbmolders.com)

58471 Fir Road  
Mishawaka, IN 46544  
Phone: 574-259-7838  
Fax: 574-259-7939



## USER INSTRUCTIONS

**Congratulations on purchasing an RV equipped with the most advanced water management system available today! Be sure to read all *Caution* and *User Instructions* on the Nautilus Panel and in your Owner's Manual before performing any operation using the Nautilus Panel System.**

**NEVER depress check valve on "CITY WATER CONNECTION" with pressure in the line. It will cause irreparable damage to the check valve function.**



58471 Fir Road, Mishawaka, IN 46544  
Phone: (574) 259-7838 Fax: (574) 259-7939  
[www.bandbmolders.com](http://www.bandbmolders.com)





## USER INSTRUCTIONS

**The Nautilus P2 Panel System will allow you to perform the following functions:**

1. Power fill your fresh water tank before remote camping
2. Use your pump to supply water to fixtures from fresh water tank
3. Connect to city water at the camping site to supply water to fixtures
4. Winterize your plumbing lines and fixtures
5. Rinse black tank to help control odors and prevent sewage buildup
6. Connect up to three (3) coax lines with satellite, cable and auxiliary



58471 Fir Road, Mishawaka, IN 46544  
Phone: (574) 259-7838 Fax: (574) 259-7939  
[www.bandbmolders.com](http://www.bandbmolders.com)



## USER INSTRUCTIONS

### CONNECTING COAX FOR CABLE AND/OR SATELLITE



1. For cable TV connection, connect the threaded coax from the source to the **"CABLE"** connection.
2. For satellite TV connection, connect the threaded coax from the satellite dish to the **"SAT"** connection.
3. Consult your Owner's Manual to see if the **"AUX"** connection has an application.



58471 Fir Road, Mishawaka, IN 46544  
Phone: (574) 259-7838 Fax: (574) 259-7939  
[www.bandbmolders.com](http://www.bandbmolders.com)



## USER INSTRUCTIONS

### Power Filling Fresh Water Tank "PowerFILL TANK"

1. Connect a garden hose to inlet labeled "CITY WATER CONNECTION."
2. **WHITE** diverter handle should be facing down in "NORMAL" position as shown.
3. **BLUE** diverter handle should be facing down in "TANK FILL" position as shown.



4. Turn water on. Fresh water tank should begin to fill.

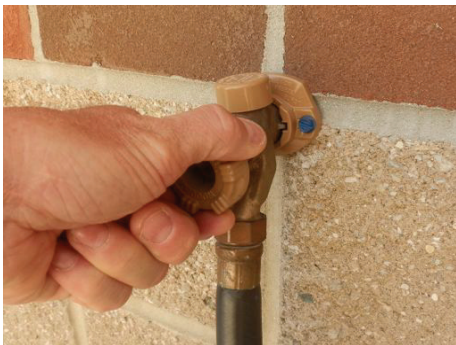

5. Consult your Owner's Manual for tank capacity. **DO NOT OVERFILL TANK!**

6. When water has reached desired level in tank, turn water off at source.



7. Disconnect garden hose at source before disconnecting from Nautilus panel.





## USER INSTRUCTIONS

### Using System from a Pressurized Water Source "CITY WATER"

1. Connect a garden hose to inlet labeled "**CITY WATER CONNECTION.**"
2. **BLUE** diverter handle should be facing right in "**CITY**" position as shown.
3. **WHITE** diverter handle should be facing down in "**NORMAL**" position as shown.



4. Turn on water supply at source. Water should be available to all fixtures.

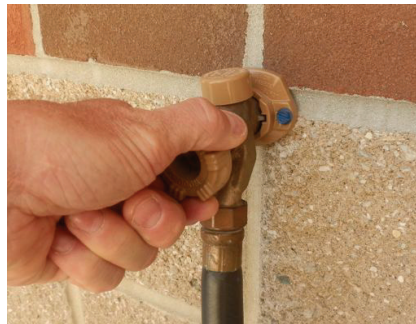

58471 Fir Road, Mishawaka, IN 46544  
Phone: (574) 259-7838 Fax: (574) 259-7939  
[www.bandbmolders.com](http://www.bandbmolders.com)



## USER INSTRUCTIONS

### Using Pump to Supply Water from Fresh Tank "DRY CAMPING"

1. Make sure fresh water tank has necessary supply of water.
2. **WHITE** diverter handle should be facing down in "**NORMAL**" position as shown.
3. **BLUE** diverter handle should be facing right in "**CITY**" position as shown.
4. Push "**PUMP**" switch so that the light on the switch is lit. Select pump switch located on the inside of unit or on Nautilus panel.
5. Pump should run now and water should be available to all fixtures.
6. Make sure pump is turned off when not in use.

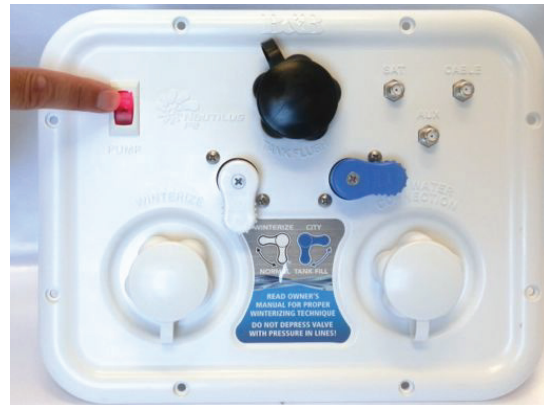

58471 Fir Road, Mishawaka, IN 46544  
 Phone: (574) 259-7838 Fax: (574) 259-7939  
[www.bandbmolders.com](http://www.bandbmolders.com)



## USER INSTRUCTIONS

### Winterizing Plumbing Lines & Fixtures "WINTERIZE"

1. Connect a garden hose to inlet labeled "WINTERIZE"
2. **BLUE** diverter handle should be facing right in "CITY" position as shown.
3. **WHITE** diverter handle should be facing left in "WINTERIZE" position as shown.



4. Place other end of garden hose in container holding approved winterizing solution.



5. Push "PUMP" switch so that light on switch is lit.





## USER INSTRUCTIONS

### Winterizing Plumbing Lines & Fixtures **"WINTERIZE"**

6. Pump should be running and winterizing solution should begin to flow through pump into plumbing lines and fixtures. (The pump will run when a plumbing fixture is open.)
7. Open one plumbing fixture, keeping it open until winterizing solution appears, then close.
8. Follow above procedure until all inside and outside plumbing fixtures have been winterized.
9. When all plumbing fixtures have been winterized, push **"PUMP"** switch so that light on switch is off.

10. Disconnect garden hose from **"WINTERIZE"** inlet.



\*\* It is normal for some winterizing solution to exit the inlet as hose is being disconnected.





## USER INSTRUCTIONS

### Rinsing the Waste Tank "TANK FLUSH"

1. Connect flexible sewer hose to 4" dump outlet.



2. Open black waste holding tank valve and leave open, allowing tank to drain.



3. Attach a garden hose to inlet labeled "TANK FLUSH."



4. Fully open faucet valve at water supply source (40 PSI minimum) flushing tank until water appears clear in 4" discharge hose.

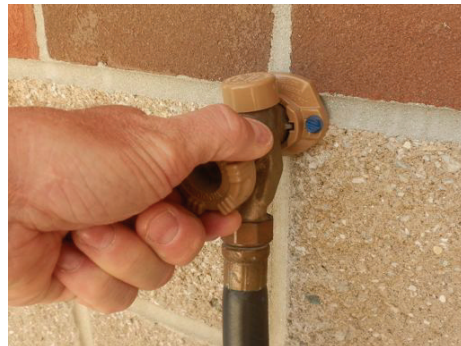





## USER INSTRUCTIONS

### Rinsing the Waste Tank "TANK FLUSH"

5. Completely close faucet at water supply source.

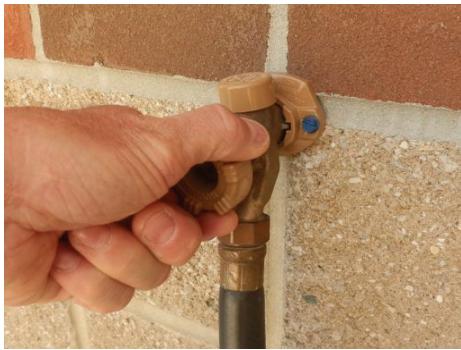

6. Disconnect garden hose from water supply source.



7. Disconnect garden hose from "TANK FLUSH" inlet.



8. Close black waste holding valve.



**NOTE:** To help debris from clogging tank sprayer orifices, use the **Tank Flusher** every Time waste holding tank is emptied.



This page is intentionally blank.

# Propane System

## Propane Gas

The propane system includes the propane cylinders, propane regulator, hoses, piping and copper tubing lines to each gas appliance. Follow the manufacturer's instructions for each propane appliance and all safety precautions.

In your RV, propane or LP (liquefied petroleum) gas is used for cooking, heating and hot water. Propane is also used for refrigeration. Propane is a colorless and odorless gas that is stored under pressure in its liquid state. As a warning agent the odorant Mercaptan is added. Many people describe this odor as similar to rotten eggs.

When a propane cylinder is low, there may be an different odor (*like onions or garlic*) that can be mistaken for a propane gas leak. This odor will usually disappear when the cylinders are filled. If not, turn off the valve(s) and have the propane system inspected by your dealer or qualified propane service representative.

### Maintenance

Although both Grand Design RV and your selling dealer carefully test the propane system for leaks, travel vibrations can loosen fittings. Have the RV's propane system checked at all connections soon after your purchase. System should also be checked when the propane tanks are filled for the first time, and again after 5,000 miles of travel.

Continue propane system checks by a qualified propane service representative (*at least once a year*) as part of your normal maintenance.

## DANGER

**IF YOU SMELL  
PROPANE GAS  
STOP!**

Quickly and carefully perform the 6-step procedure in the red box at the bottom of this page.

Do not remove the following labels from the RV:

**⚠ DANGER**

ALL PILOT LIGHTS, APPLIANCES AND THEIR IGNITORS (SEE OPERATING INSTRUCTIONS) SHALL BE TURNED OFF BEFORE REFUELING OF FUEL TANKS AND/OR PROPANE CONTAINERS. FAILURE TO COMPLY COULD RESULT IN DEATH OR SERIOUS INJURY.

**⚠ WARNING**

DO NOT FILL PROPANE CONTAINER(S) TO MORE THAN 80 PERCENT OF CAPACITY. FAILURE TO COMPLY COULD RESULT IN A FIRE OR PERSONAL INJURY.

**⚠ CAUTION**

THIS PROPANE PIPING SYSTEM IS DESIGNED FOR USE WITH PROPANE ONLY. DO NOT CONNECT NATURAL GAS TO THIS SYSTEM. Securely cap inlet when not connected for use. After turning on propane, except after normal cylinder replacement, test propane piping and connections to appliances for leakage with soapy water or bubble solution. Do not use products that contain ammonia or chlorine. LD-101

### IF YOU SMELL PROPANE

1. Extinguish any open flames, pilot lights and all smoking materials.
2. Do not touch electrical switches.
3. Shut off the propane supply at the container valve(s) or propane supply connection.
4. Open doors and other ventilating openings.
5. Leave the area until odor clears.
6. Have the propane system checked and leakage source corrected before using again.

**FAILURE TO COMPLY COULD RESULT IN EXPLOSION  
RESULTING IN DEATH OR SERIOUS INJURY**

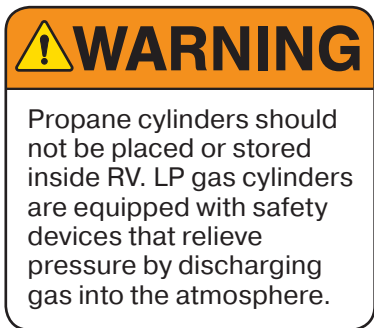

## Propane Gas Cylinders

Propane gas, while under pressure in the cylinder, is compressed into its liquid form. As the fuel is released from the cylinder, it changes from liquid to gas, and is used to operate the appliances. Propane will not run through the appliances in the liquid state. Propane expands 1½ percent for every ten degrees of increase in temperature.

- **IMPORTANT: Sufficient space MUST be left inside the container to allow for natural expansion of gas during warmer weather.**

Propane cylinders (also referred to as LP bottles) are used for the storage and delivery of propane gas. Propane cylinders are filled by weight, expressed in pounds. For filling, a qualified propane facility is required, and cylinders must be removed from the RV.

When the propane system is not in use, the main shut off valve must be kept closed. To close the propane cylinder main shut off valve: **HAND TIGHTEN ONLY, do not use tools.** Over-tightening may damage the interior seals on the cylinder valve seat. If this type of damage occurs, the cylinder will not close properly.

DOT (Department Of Transportation) cylinders are the most common for use on RV trailers. DOT cylinders equipped with an OPD and ACME type 1 service valve are identified by the triangular service valve knob.

- ALWAYS close the service valve and install a dust cap or plug when transporting or storing disconnected containers whether full or empty.

DOT cylinders are typically marked with “top” or an arrow indicating the correct orientation of the cylinder(s.)

- ALWAYS mount, store and transport the cylinder(s) in the position specified.
- ALWAYS securely re-install DOT cylinder(s) to the RV after they have been removed for filling or replacement.

The cylinders are equipped with an **Over-fill Protection Device (OPD)** designed to reduce the potential of overfilling. They are also equipped with an ACME service valve that is for connection of the TYPE 1 ACME pigtail hose assembly to the RV two-stage regulator. The TYPE 1 ACME pigtail hose assembly is a wrenchless, user friendly, right hand threaded connector that features a thermally sensitive sleeve and excess flow device.

Max output is 200,000 BTU/hr. It is used to connect propane cylinders to regulators, hoses and other fittings. It is not for use on gas grills and other low pressure devices.

### Servicing or filling

Have the RV checked for leaks at the connections on the propane system soon after the purchase and the initial filling of each propane cylinder.

- **While the propane tanks are being filled, ONLY the qualified propane service technician should be near the RV. No one should be inside.**

When you have a new cylinder filled for the first time, make sure your propane supplier purges your new cylinder of trapped air. Otherwise, an improper mixture of gas and air will make it impossible to light your propane appliances. For best performance the new propane cylinder must be carefully purged before filling.

### LP gas container overfill

NEVER allow your propane cylinder(s) to be filled beyond the maximum safe level marked on the cylinder. Your propane system is designed for gas vapor only. An overfilled cylinder could force *liquid* propane into the system, creating a hazardous condition.

## Propane Leak Test

**ALWAYS** test for leaks with a solution of dish soap and water. Apply the solution with a spray bottle, to the outside of all gas line joints and fittings. If a leak is present, the soapy solution will bubble at the leak point. As a general rule, small bubbles indicate a small leak while large bubbles indicate a larger leak.

**NEVER** use a solution containing ammonia or chlorine when locating leaks. These products are corrosive to copper gas lines and brass fittings, which could result in deterioration of the copper and brass components.

If a leak is not fixed by tightening the connection, shut OFF the propane system valve(s) and immediately contact your dealer or a qualified propane service representative.

### **WARNING**

Before entering a propane or fuel service station make sure all pilot lights are extinguished. Shut off gas to all appliances by closing the propane gas main shut off valve. Always shut OFF any engine before refueling. Do not smoke and do not operate other ignition sources while refueling.

### **WARNING**

If you suspect your propane container has been overfilled, contact your dealer or a qualified propane technician for assistance immediately. Do not use or attempt to service an overfilled propane container yourself.

### **DANGER**

Extinguish all flames. Never use an open flame to check for leaks. Failure to follow this warning could result in a fire or explosion resulting in serious injury or death.

### **WARNING**

Do not check for leaks using products that contain ammonia or chlorine; these products can cause cracks to form on the metal tubing and brass fittings.

 **WARNING**

Test Propane Gas Alarm operation after the RV has been in storage, before each trip and at least once per week during use.

 **WARNING**

Never turn the 12-volt battery disconnect control to the off position and disconnect the battery cable to silence the alarm.

 **WARNING**

The pigtail hose must be installed to avoid tension or pulling stress at either end of the hose. Keep the pigtail hose away from sharp edges of the cylinder collar, rigid corners, walls, doors or other compartment structures including the cover.

 **WARNING**

Ensure that all fasteners are secured before traveling.

## Propane Alarm

Your RV is equipped with a propane alarm. Please read and follow the component manufacturer instructions supplied in your Owner Information Package.

*For detailed information on this alarm, See **Pages 41 & 42, Occupant Safety***

## Installing The Propane Cylinders

The position of the propane cylinder(s) and hoses is critical to proper operation and propane flow. Follow these instructions to make sure your propane container(s) are connected properly.

1. Make sure all the RV appliances are shut off.
2. Make sure each LP cylinder shut-off valve is closed.
3. Connect the 3/8" low-pressure hose to the outlet of the two-stage regulator.
4. Place the cylinder on the bracket in the recess compartment or housing and secure it so the outlets of the cylinder valve are facing the "sidewall" of the compartment or housing.
5. Mount the regulator on the center back wall of the compartment or housing so the vent is pointed downward.
6. Attach the 1/4" inverted flare x 18" Type-1 pigtail hose to the regulator inlet and the right hand swivel nut to the cylinder valve.
7. Attach the main supply hose from the regulator to the brass manifold fitting in the frame of the trailer. The swivel brass nut on the main hose will be your final attachment.

### **Remember each time the propane container is removed:**

- Check that ALL fittings are tight.
- Check that ALL connections are tested with a propane leak detector (or soapy water) solution.
- Open the main shut-off valve on the LP cylinder **slowly**. This avoids *propane freeze up*, caused by a fast rush of propane to the excess flow valve.

- If you do experience a *propane freeze up*, close the main valve and wait at least fifteen (15) minutes before trying again. *For more information, refer to the regulator manufacturer's operator manual.*
- Listen carefully. A *hissing* sound longer than one second, may indicate a propane leak. If you suspect that there is a leak, close the shut-off valve, *then* contact your dealer or qualified propane technician for repair assistance.
- Replace all protective covers and caps on the propane system after filling. Make sure the valve is closed. Install the LP bottle cover and use the bungee cord at the bottom to secure it in place for travel or storage purposes.

## Propane Regulator

The two-stage regulator has the only moving components in the propane system. Its sole function is to reduce the pressure from the propane containers to a safe and consistent low operating pressure.

The first stage reduces the container pressure to 10-13 lbs. The second stage further reduces the 10-13 lbs. of pressure to an operating pressure of 11" W.C. (water column) or 6.35 oz. of outlet pressure to your appliances.

For optimum performance, the second stage will need to be adjusted by your dealer (or qualified propane service technician) using a properly calibrated manometer.

- If the pressure is **too high**, the propane system's performance and safety will be affected.
- If the pressure is **too low**, the appliances will not operate correctly.

If your RV is equipped with the *automatic* two-stage regulator, with both cylinders full of propane, turn the lever on the regulator towards the cylinder you wish to use first. This will now be the *supply* cylinder and the other the *reserve*.

Slowly open both cylinder valves. The indicator on top of the regulator will change to **green**. When the *supply* cylinder is empty, the indicator will change to **red**. Now turn the regulator lever to the *reserve* cylinder side and the green signal should return. You may now remove the empty cylinder to have it refilled without interrupting the flow from the full bottle. After filling the cylinder, connect the pigtail hose and slowly open the bottle valve.

### **WARNING**

All propane connections should be checked periodically as vibrations from travel may cause them to loosen. Failure to check connections could lead to a leak of propane, resulting in a fire or explosion that could cause serious injury or death

### **WARNING**

Propane regulators must always be installed with the regulator vent facing downward. Regulators that are not located in baggage compartments have been equipped with a protective cover. Make sure the regulator vent faces downward and (if applicable) the cover is in place to minimize vent blockage that could result in excessive gas pressure causing fire or explosion.



 LP Regulator: The red color on the top dial indicates the LP bottles are empty. If the LP bottles were full, the dial would show green.



When there are double cylinders on your RV, use only one at a time.

Otherwise, the propane supply will be drawn equally from both cylinders until the supply has been exhausted. Using one cylinder until it is empty, before using the second, allows you to fill the empty cylinder at your convenience without running out of propane.

## Propane System Hoses, Tubes, Pipes & Fittings

The hoses, pipes, tubes and fittings used in your propane system are designed to withstand pressures exceeding those of the propane system. However, because environment and time can both contribute to the deterioration of these components, they must be inspected for wear at regular intervals. Be sure to inspect the hose before each season and when having the tank refilled. Look for signs of deterioration such as cracks or loss of flexibility. When replacing the hose or other propane components, always replace them with components of the same type and rating (check with your dealer).

Fittings are used to connect the various system components to each other. The P.O.L. fitting at the end of the propane supply hose is made of brass so that pipe sealants are not necessary to prevent leaking. It also has a left-handed thread, which means that it is turned clockwise to remove, and counter-clockwise to tighten. The P.O.L. fitting has been designed to help restrict the flow of LP gas in the event of a regulator failure or hose malfunction.

## Cooking with Propane

Unlike homes, the amount of oxygen supply is limited due to the size of the RV. Proper ventilation when using the cooking appliance(s) will help you avoid the danger of asphyxiation.

***For additional safety instructions, See Page 145, Appliances.***

## Traveling with Propane

BEFORE towing your RV, confirm that the propane containers are properly fastened in place. Turn OFF the gas at the LP bottle. This disables all gas appliances and pilot lights.

DO NOT operate the propane system when the RV is in motion. Some states prohibit propane appliances to be operated during travel (especially in underground tunnels). Make sure to know the laws for the areas where you travel.



## Using the Propane System

After the RV is completely set up and you are prepared for camping enjoyment, use the following steps for propane operation:

1. Close ALL burner valves, controls and pilot light valves.
2. Open the main valve in the propane container slowly to avoid a fast rush of propane vapor through the excess flow valve causing propane “freeze-up.” Should you experience propane “freeze-up,” close the main valve and wait 15 minutes before trying again.
3. Listen carefully as propane begins to flow. If a hissing noise is heard for more than one or two seconds, close the main valve and contact your dealer to have the propane system tested.
4. Light the appliances as directed in the appropriate manufacturer manual from your Owner Information Package.

**BEFORE using the propane system, make sure that you read and understand ALL instructions and safety requirements.** The Owner Information Package contains operator manuals for the various appliances hooked to your propane system.

*If you have additional questions or concerns, Consult with your dealer and/or the specific manufacturer.*

### **WARNING**

Gas appliances must never be operated while RV is in motion. Unpredictable wind currents may be created which could cause flame reversal in the water heater burner tube, which could result in fire damage.

The water heater thermal cut off fuse could also be unnecessarily activated resulting in a complete shut down of the water heater requiring replacement of the thermal cut off.

## Calculating Propane Use

Your Reflection FW's furnace, refrigerator, water heater and range (if applicable) all may use propane to operate. Use the BTU rating of each appliance to determine how long your propane supply will last. Propane consumption depends on their individual use and the length of time operated.

Most RV gas appliances are operated intermittently. Unless there is heavy use of hot water, the water heater consumption of propane is minimal. During cool temperature or high wind conditions, furnace consumption can be extremely high.

To calculate your propane supply, take the BTU ratings for your propane appliances and divide that into the BTU availability. Each gallon of propane (3.86 liters) produces about 91,500 BTUs (46,514 kilojoules) of heat energy.

The following chart provides *Average Propane Consumption* information.

<b>Appliance</b>	<b>Average BTU Consumption/HR.</b>	<b>Kilojoules/HR.</b>
Water Heater	8,800	9,280
Refrigerator	640-1,200	680-1,270
Furnace	16,000 - 35,000	16,880 - 36,930
Range w/ Oven	7,100	7,490
Range - Rear Burner	6,500	6,860
Range - Front Burner	9,000	9,490

## Appliances

The following is a brief overview of the factory-installed, RV appliances and equipment. For detailed operating instructions for each specific component, please refer to the manufacturer's owner manuals (found in your Owner Information Package) or visit that manufacturer's website.

*If there have been modifications or replacements made to your RV, then these instructions may not apply. Please contact the service center or technician who performed the modifications or substitutions if assistance is required.*

### Microwave

Make sure there is sufficient 120-volt power available before operating the microwave. To prevent damage, ensure the microwave turntable is secured prior to traveling.

### Refrigerator

The refrigerator is not intended for quick freezing or cooling. We recommend stocking it with pre-frozen or pre-cooled food when possible. The shelves should not be covered with paper or plastic and the food items should be arranged so air can circulate freely. Keep the area at the back of the refrigerator clean and free of debris. Check for obstructions in the exterior refrigerator vent area (i.e., spider webs, bird nests, etc.). Use a soft cloth to dust off the debris. For optimum efficiency and performance, it is recommended the refrigerator be checked at least twice a year as part of the routine maintenance.

### Washer/Dryer Prep

If your RV was built with this feature, be aware the cabinet space provided is intended for the installation of an after-market RV-rated washer/dryer (customer supplied) only. Please consult your dealer or the appliance manufacturer for installation assistance.

## DANGER

IF YOU SMELL  
PROPANE GAS  
**STOP!**

Quickly and carefully perform the 6-step procedure below:

### DANGER

IF YOU SMELL PROPANE

1. Extinguish any open flames, pilot lights and all smoking materials.
2. Do not touch electrical switches.
3. Shut off the propane supply at the container valve(s) or propane supply connection.
4. Open doors and other ventilating openings.
5. Leave the area until odor clears.
6. Have the propane system checked and leakage source corrected before using again.

FAILURE TO COMPLY COULD RESULT IN EXPLOSION RESULTING IN DEATH OR SERIOUS INJURY. LD-101

## DANGER

DO NOT USE  
GAS COOKING APPLIANCES  
FOR COMFORT HEATING.

This may lead to carbon monoxide poisoning, which can lead to death or serious injury.

## WARNING

Do not use portable fuel burning equipment (i.e., wood and charcoal grills or stoves) inside the RV. Use of these items inside an RV may cause fires or inability to breathe.

 **WARNING**

Do not turn the gas range burner controls ON and allow propane gas to escape before lighting.

 **WARNING**

During and after use, do not touch or let clothing or other flammable material come in contact with the top burners (or heating elements), burner grates or other areas near the top burners or oven until they have had sufficient time to cool. These areas can get hot enough to cause burns.

 **WARNING**

Never leave cooking food unattended. Turn pan handles inward, but not over the tops of the other range burners. Ensure that pans used are large enough to contain the food and avoid boil-overs. Heavy splattering or spills left on the cook top can ignite and cause burns.

 **WARNING**

Do not cover the oven vent openings while the oven is in operation. Restricting the flow of combustion air will create an asphyxiation hazard.

## Oven

The propane gas oven ignites using a pilot light. If you have any questions contact your dealer or our customer service department. Do not use the oven as a storage area. For additional information refer to the manufacturer's owners' manual included in the warranty packet.

## Range Hood

The range hood has a both a light and fan control switch on the front panel. The 8" x 8" aluminum mesh grease filter (located on the underside range hood) of the can be gently hand-washed using mild soap and water.

## Range Top with Oven

To prevent damage, always use the manufacturer recommended size flat bottom pan(s). Generally, the pan should be large enough to cover the range top burner, but not be more than one inch larger than the burner grate.

Do not use a broiler pan, griddle or any other large utensil that covers more than one range top burner at a time. This will create excessive heat that may cause melting, sooting or discoloration.

In addition, the use of undersized pans could expose a portion of the heating element to direct contact and may result in ignition of clothing. Proper relationship of pans to burner will improve efficiency.

## Cooking with Propane

**For additional safety instructions, See Pages 137 - 143, Propane System.**

### In Case Of A Grease Fire

Grease is flammable. Never allow grease to collect around the top burners or on the cook top surface. Wipe spills immediately. If a fire does start, follow these basic safety rules:

1. Have everyone evacuate the RV immediately.
2. After everyone is clear and accounted for, check the fire to see if you can attempt to put it out. If it is large or the fire is fuel-fed, get clear of the RV and have the Fire Department handle the emergency.
3. Try to smother a flaming pan with a tight-fitting lid or cookie sheet.
4. Never pick up a flaming pan.
5. Flaming grease outside of the pan can be extinguished with baking soda or a multipurpose dry chemical or foam-type fire extinguisher.

### **WARNING**

If using glass, ceramic, earthenware or other glazed utensils (or cookware) verify that it is safe for use on the top burners. Only certain types of utensils (or cookware) are suitable for surface or top burner use.

## Electronics

The following is a basic overview of the audio/visual (A/V) electronics operation. The information in this section is written for original factory-installed equipment usage. If there have been modifications or replacements made to your electronics system then these instructions may not apply (please contact the service center or technician who performed the modifications or substitutions if assistance is required).

Refer to the manufacturer's user guides included in your Owner Information Package for detailed operating instructions for each specific component, or visit that manufacturer's website.

### Audio/Visual System Guide

#### Radio operation:

1. Turn ON the radio.
2. Select speaker output using the controls on the radio face.

#### CD operation

1. Turn ON the radio.
2. Select speaker output using the controls on the radio face.
3. Insert CD to play.

#### TV operation

1. Turn on the TV power supply.
2. Crank the TV antenna up.
3. Turn on the TV and select your signal input using the "source" button.

#### DVD operation

1. Turn off the TV power supply.
2. Turn ON the radio (the TV speakers are not used).
3. Insert DVD to play.
4. Turn on the TV and select your signal input using the "source" button.
5. Select speaker output using the controls on the radio face (the TV speakers are not used).

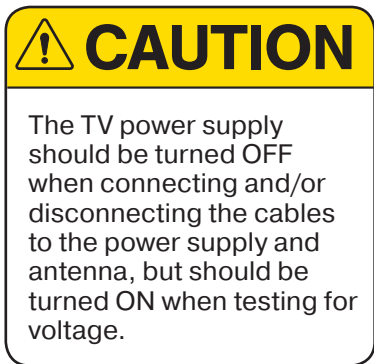

## TV Reception Basics

TV broadcasting is a point-to-point communication. Any obstructions between the transmitter and the antenna will degrade the signal, affecting picture quality.

- Television stations transmit their broadcast signal "over the air" to surrounding areas.
- TV antennas are designed to receive the broadcast signals.
- Picture quality depends on the antenna type and your distance from the transmitter.
- The further you are from the transmitter, the weaker the signal becomes, affecting picture quality.

## TV Signal Booster

- **The TV Signal Booster must be turned ON for improved *antenna* reception.**
- The TV Signal Booster sends 12-volt DC power to the TV roof antenna. This voltage energizes the transistors in the antenna head amplifier.
- Turn OFF the *TV Signal Booster* to view cable/satellite TV, or to use a DVD/Blu-ray player or Game System.

## Cable/Satellite Outlet

Both Cable and Satellite connection outlets are found in the outside utility center.

- The *Cable* input connects to an RG6 cable run through in-line splitters to provide service at multiple locations.
- The *Satellite* inputs connect to RG6 cables run directly to specific locations (no splitters). This allows for clean transfer of HD signals from the satellite dish.

*Please refer to the (customer supplied) satellite manufacturer manual for setup, care and maintenance instructions.*



Many television stations have changed from VHF to UHF channels. UHF channels operate at higher frequencies; the signal does not travel as far as those of VHF. If your TV is digital, you do not need a converter box or any other external, add-on device. If your antenna was working prior to the digital change, it is probably working now. Check the TV or the settings if you have problems receiving DTV channels. For more troubleshooting tips, go to [www.antennatek.com](http://www.antennatek.com).

## TV Roof Antenna

To watch local TV stations, turn ON power to both the TV and the TV Roof Antenna. For the best TV reception, your antenna must point toward the nearest signal transmitter. You can find the exact locations of transmitting towers at [www.fcc.gov](http://www.fcc.gov).

### To Aim the Antenna

1. Turn ON the TV signal booster switch, *then* turn ON the power to your TV. On the TV menu, set the input of the TV to "ANTENNA," "BROADCAST" or "OFF AIR."

**NOTE:** Steps 2-6 *rotate* the antenna to locate the best possible signal. Keep track of the knob position where you receive the highest number of channels.

2. Press the button and rotate the antenna all of the way in one direction until it hits the stop.
3. Scan for channels on the TV or TV converter box per the manufacturer's instructions. *Note how many channels are received.*
4. Press the button and rotate antenna 90 degrees. Scan again. *Note how many channels are received.*
5. Press the button and rotate antenna 90 degrees. Scan again. *Note how many channels are received.*
6. Press the button and rotate antenna 90 degrees. Scan again. *Note how many channels are received.*
7. **Now, set your antenna to the position where the highest number of channels was received.**
  - Choose one of those channels on your TV.
  - Monitor the signal strength screen and fine tune the antenna until the highest signal strength is achieved.
8. Scan for channels one final time, *then* Watch TV.



## Heating & Cooling

This section contains an overview of the RV heating and cooling components. It applies only to the original factory-installed equipment. For more information on each specific component, please refer to the manufacturer's operating instructions, or visit that manufacturer's website.

*If there have been modifications or replacements made to your RV, then these instructions may not apply. Please contact the service center or technician who performed the modifications or substitutions if assistance is required.*

### Ducting & Return Air

All heat discharges, registers and return air grills must be free and clear of obstructions. The adjustable registers are only intended to *reduce* airflow as needed, they should NOT be completely closed.

### Roof Vent

The roof vents allow fresh air to circulate through your RV. They may be electric (12-volt DC) and/or manual. Make sure that roof vents are closed while traveling, and when you will be away from the RV, to prevent unexpected weather damage.

### Thermostat

#### Fan Mode Setting

Press the Power/Mode button until the fan mode is active. Press the  $\triangle$  or  $\nabla$  button to cycle through the fan speed options Low, High, and Auto.

#### Mode of Operation

Press the Power/Mode button to cycle through the available modes. All CT Thermostats have Cool and Furnace modes. Select models will have an additional mode, either Heat Pump or Heat Strip. The active mode will display on the LCD.

To set or adjust the thermostat, press the  $\triangle$  or  $\nabla$  button to increase or decrease the temperature setting.

## NOTICE

Do not leave a roof vent open when the RV is stored or unattended for long periods. High winds, other unusual conditions or obstructions may occur; and if so, the resulting leakage could cause non-warrantable damage.



*The Digital Thermostat is wall-mounted inside the RV*

**! WARNING**

Do not operate the furnace when the slide room is retracted (in the closed position).

**! WARNING**

The furnace should be inspected periodically (monthly during the heating season) for the presence of soot on the vent. Soot is formed whenever combustion is incomplete. This is a visual warning that the furnace is operating in an unsafe manner. If soot is observed on the vent, immediately shut the furnace OFF and contact a qualified service agency. Operating the furnace under this condition could lead to serious property damage, personal injury or loss of life.

**! WARNING**

To ensure your personal safety, do not obstruct or alter the furnace in any manner. Do not install screens over the vent for any reason. Screens will become restricted and cause unsafe furnace operation. For your safety, only OEM factory authorized parts are to be used on your furnace.

## Thermostat, Continued

### Inside Temperature

To display the Inside Temperature, the CT Thermostat must be in the OFF Mode. Press either the  $\triangle$  or  $\nabla$  button to display the Inside Temperature.

### Fireplace

Please refer to the OEM manual for operation, service and maintenance information.

*If you have further questions, please contact your dealer.*

### Furnace

The RV furnace installed in the RV is controlled by a thermostat. The furnace requires both 12-volt power and propane gas for full operation. Make sure you have sufficient power available before operating your furnace.

NEVER attempt to repair the furnace yourself. ALWAYS have your furnace maintenance completed by a qualified technician at least once a year (more often depending on furnace use).

*If you have any questions, Contact your dealer or Grand Design Customer Service*

### Air Conditioner

Your thermostat controls the roof-mounted air conditioning system equipped on your RV. ALWAYS check that you have sufficient power available before operating the air conditioner.

### Cooling vs. heat gain

The roof air conditioner can, at best, cool the air it intakes by 20 ° F. During hot weather, through the day, your RV will absorb heat, increasing the inside temperature. This is referred to as *heat gain*.

To keep the inside temperature comfortable, reducing heat gain of the RV is just as important as the cooling ability of your air conditioner. To reduce heat gain, follow these steps:

1. Park the RV in a shaded area.
2. CLOSE the blinds or drapes.

3. Use the awnings to shade your RV from sun exposure.
4. Avoid the use of heat producing appliances.
5. SET the air conditioner *Fan/Cooling mode* to HIGH. In high humidity or high temperatures, this will provide maximum efficiency.
6. Turn ON the air conditioner early in the morning, to give it a head start on cooling.

### Air conditioner gasket

A special foam gasket is placed between the roof material and the sub-frame of the air conditioner to weatherproof the seal. The air conditioner is subjected to wind pressures along with motor vibration during normal operation.

Inspect the gasket seal (at least) annually. Check for leaks and re-tighten the mounting bolts if needed. To prevent damage to the gasket, be careful NOT to *over-tighten* the bolts.

The air conditioner gasket is a wearable part that eventually will need replacement. To gain access to the bolts, remove the filtered panel cover on central air systems or the entire air box on non-central air conditioners.

### Heat pump

A heat pump is one base unit that can operate in two modes, heating or cooling. The travel or flow of the refrigerant is reversed depending on which cycle you choose to operate:

- Cooling Mode: Heat is removed from the *inside* air and released to the *outside* air.
- Heating Mode: Heat is removed from the *outside* air and released to the *inside* air.

## Patio Awning

It is very important to keep your awning clean and in good condition to prevent costly repairs. ALWAYS close the awning into the travel mode position, if weather conditions are windy or stormy, or if you will be away from the RV for an extended period of time.

*For more information, please refer to the awning manufacturer's user manual.*

## NOTICE

Do not operate the air conditioner without the Return Air Filter. Operation without the filter allows lint and dirt normally stopped by the filter to accumulate on the air conditioner's cooling coil. This will lead to a loss of air volume, possible equipment damage and an expensive cleaning process.

## WARNING

Do not attempt any repairs to any awning. The awning roll tube is under extreme spring tension. Repairs should only be performed by an authorized dealer and/or repair center.

## WARNING

Awnings must be closed and locked (if applicable) while the RV is in transit.



*The Patio Awning Switch is located inside the RV, on the Command Center.*

 **WARNING**

The slideout room and mechanism are a potential crush hazard. Disconnect the auxiliary battery to disable power to the slideout(s) before working on or under them. Failure to do so could result in serious injury or death.

 **WARNING**

Stand clear of the room's interior path and verify there are no exterior obstructions before extending or retracting the slide-out. Failure to do so could result in serious injury or death.

 **WARNING**

The slideout mechanism has hard, sharp metal edges. Do not allow children to play under a slideout in the extended position. Failure to do so could result in serious injury or death.

 **WARNING**

Ensure the slideout is in the closed position prior to hooking the RV to the tow vehicle. Failure to do so could result in serious injury or death.

## Slideout Systems

Slideout rooms are designed to provide you additional living space during stationary camping.

**BEFORE operating your slideout system:**

- Check that you have sufficient power available.
  - Level *and* Stabilize the RV
- 
- Leveling helps to keep the RV square, so the slideouts extend, retract and seal correctly.
  - If the RV is NOT level, the slideout rooms and/or mechanisms may become damaged.
  - The slideout rooms DO NOT need additional support. Non-warranty damage can occur from improper use of aftermarket support jacks.

### Slideout Operation

It is normal for the slide rooms to make *creaking* or *squeaking* noises while moving. These noises are especially common during the break-in period while the components are seating properly. This will decrease after a few extend/retract cycles. Note that there will always be some noticeable noises when operating the slideout.

1. **ALWAYS level and stabilize the RV, BEFORE operating your slideout system.**
2. Check that your auxiliary battery is fully charged or the RV is connected to shore power. Turn off all unnecessary lights to maximize available power.
3. Close all cabinet doors and drawers.
4. BEFORE extending or retracting:
  - Check that the *interior* path of the slideout room is clear of people, pets, furniture, clothing, etc.
  - Check that the *exterior* path of the slideout room is free from any obstructions.

5. Inspect the sides, top and bottom of the extended slide-out room. If the outside of the slideout room is wet, wipe it dry before retracting.
6. Clean any water puddles or debris brought inside your RV from slideout operation immediately.
7. Press and hold the appropriate slide room switch to either IN or OUT, until the room is completely extended or retracted.

- DO NOT hold the slide room switch past the point the room is fully extended/retracted or damage may occur.
- For the weather seals to be effective, the slideout room MUST be *completely* extended/retracted.
- BEFORE operating your slide systems, review all important safety alerts.

### Slideout maintenance

While the slideout room is *extended*, the outside surfaces of the room and mechanism may collect dirt and debris. The slideout seals are not designed to remove the debris or any water that may accumulate.

- When you **retract** the slideout, any debris on the *outside* of the room, is brought *inside* your RV.

BEFORE retracting the slideout(s):

- Inspect the outside surfaces for snow, ice, dirt, dust, insect nests, etc.
- Check for standing water on the slideout topper awning (if so equipped).
- Wipe the outside surfaces of the room and mechanism dry and/or clean as much as possible.

### If your slideout system:

- Stalls out before reaching end of stroke, or
- Does NOT close and seal tightly.

Contact your dealer or Grand Design RV Customer Service for trouble shooting and/or repair.



The Slide Room Switches are located inside the RV, on the Command Center.

## NOTICE

**Ensure that the RV is level before operating the slideout room.**

Water leaks and other problems could result if the slideout is operated without leveling the RV.

## NOTICE

Do not place excessive weight in the slideout room. It can cause the slideout room to malfunction and cause damage to the slideout.

## NOTICE

For long-term storage, it is recommended that the slide rooms be closed (retracted).

## NOTICE

Use **EXTREME CAUTION** if using the manual override feature to extend and/or retract the room.

It is possible to extend or retract the slideout beyond the maximum open or closed positions. This can result in damage to the slide components, slide room structure or trim components.

## Lippert Electric Slideout System

Extending and retracting the slideout room is powered by the Lippert Through Frame Electric Slideout System. It is a rack and pinion guide system with a motor driven ball screw actuator. The actuator is equipped with an automatic clutching system. The Through Frame Electric Slideout System is a negative ground system.

### Manual operation

The Lippert Through Frame Electric Slideout System comes with a manual override. Locate the 1" round Slideout Override Access Hole in the skirt metal on the opposite side (of the RV) from the room that you are trying to move.

- Insert the crank handle extension.
- Turn **clockwise** to retract the slideout room.
- Turn **counter-clockwise** to extend the slideout room.

**Use EXTREME CAUTION if using the manual override feature to extend and/or retract the room.**

- It is possible to extend or retract the slideout beyond the maximum open or closed positions. This can result in damage to the slide components, slide room structure or trim components.
- **Important:** The actuator is *manual ready*. **DO NOT** disengage the motor. Just hook up and crank.



*Slideout Override Access Hole  
& Crank Handle Extension*

## Maintenance

Although the system is designed to be almost maintenance free, actuate the room once or twice a month to keep the seals and internal moving parts lubricated. Check for any visible signs or external damage before and after movement of the RV.

- For the best performance, the slideout system requires the auxiliary battery be fully charged.
- Check for corrosion, and loose or damaged terminals/connections at the battery, the control switch, and the electronic actuator motor.
- Check that the motor leads under the RV chassis are in good condition. These connections are subject to damage from road debris.
- When operating the Lippert electric slideout system in harsh environments (i.e., road salt, ice buildup, etc.) keep all moving parts clean, washing them as needed, with mild soap and water.
- Grease or lubrication is NOT necessary. It could even harm the long-term dependability of the slideout system.

## Service and adjustments

Any slideout room adjustments must be performed by a certified RV service technician. Adjustments made by non-certified persons may void any and all warranty claims.

### **NOTICE**

For long-term storage, it is recommended that the slide rooms be closed (retracted).

**CAUTION**

During this override procedure, the Schwintek slide room motors are not synchronized. Visually watch the slide room, and if one side is moving significantly slower than the other (or not at all), immediately stop and call your dealer or Grand Design RV Customer Service.

## Schwintek In-Wall Slideout System

If the bedroom IN-WALL slideout does not extend or retract, follow these steps to override the system (it will be easier if you have one or more persons to assist you):

Typical IN-WALL slide controller, located in the front facing compartment of your FW.

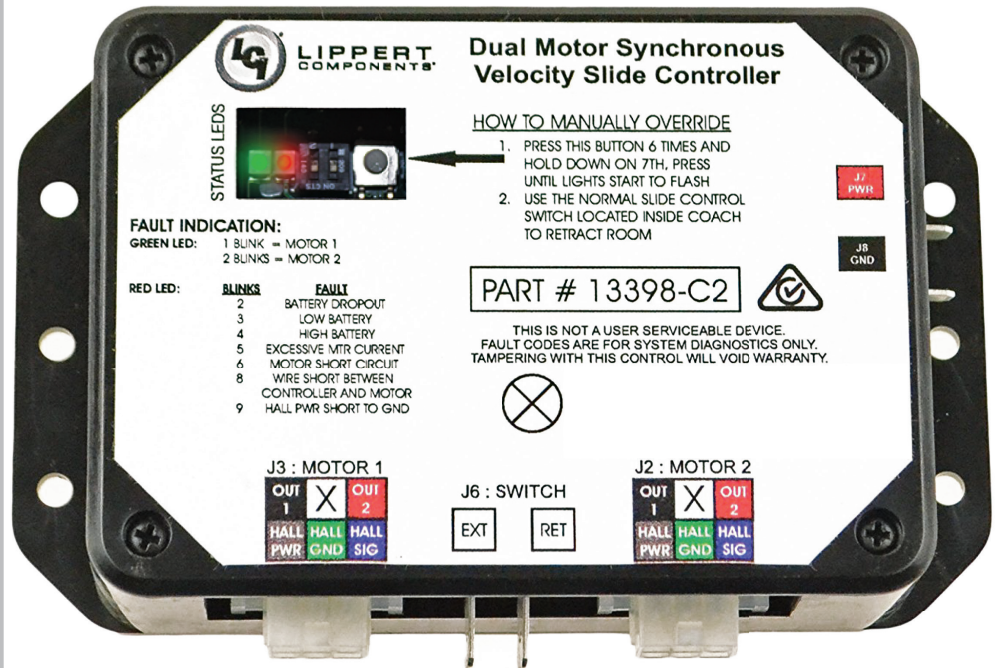

### Electronic manual override (for board revision C1 and newer):

1. Locate the circuit board.
2. Press the *MODE* button six (6) times quickly, press a seventh (7th) time and hold for approximately five (5) seconds.
3. The RED and GREEN LED lights will begin to flash, confirming the override mode.
4. Release the *MODE* button.
5. Back inside the RV, press and hold the Slide Room 2 switch *IN* button until the room retracts completely.



**Manually push the slide room in override**

1. Locate the circuit board.
2. Unplug both motors from circuit board.  
(this releases the motor brake)
3. Push or pull slide room in as desired;
  - Larger rooms may require several people to push.
  - Keep both sides of room relatively even.
4. When the bedroom slide is completely in, plug both the motors back in to the control board (this applies the motor brake for road travel).

**Disengage motors, manually retract room and travel lock:**

1. Locate and remove motor retention screw located near the top of each vertical column.
2. Bend back the wipe seal and visually locate motor.
3. Pull the motor up until disengaged, about 1/2".  
Replace the motor retention screw to hold the motor in this position.
4. Repeat this process for both sides of the slide room.
5. Push or pull the slide room back in to the opening, keeping the side of the slide room relatively even.
6. Re-engage motor to be ready for travel.
7. The room must be travel locked to keep room in place for road travel.

## Troubleshooting the Schwintek In-Wall Slide System

### Error codes

During operation, when an error occurs the board will use the LED's to indicate where the problem exists.

- For motor specific faults, the GREEN LED will **blink once** for motor 1, and **twice** for motor 2.
- For error codes, the RED LED will **blink** between two and nine (2-9) times to indicate the error code (see below)

Red LED Error Code	Error Code Description
2	Battery drop out; battery capacity low enough to drop below 6 volts while running.
3	Low battery; voltage below 8 volts at start of cycle.
4	High battery; voltage greater than 18 volts.
5	Excessive motor current; high amperage, also indicated by one (1) side of slide continually stalling.
6	Motor short circuit; motor or wiring to motor has shorted out.
8	Hall signal not present; encoder is not providing a signal.
9	Hall power short; power to encoder has been shorted to ground. Usually a wiring problem.

When an error code is present, the board needs to be reset. Energizing the extend/retract switch resets the board. Energize the extend/retract switch again for normal operation.

### Checking fuses

The IN-WALL slide system requires a minimum of 30-amp fuse. Check the fuse box (located in the command center) for blown fuses, and replace as necessary. If the fuse blows immediately upon replacement, there may be a problem with the wiring to the control box (contact your dealer for assistance).

## Low voltage

The IN-WALL slide controller is capable of operating the bedroom slide room with as little as 8-volts. But at these lower voltages the amperage requirement is greater. Check the voltage at the controller; if the voltage is lower than 11-volts, it is recommended that the auxiliary battery be placed on a charger until it is fully charged.

## Only one (1) side moving

The IN-WALL slide system has a separate motor to operate each side of the room. If only one side of the room moves a short distance (2 to 4 inches) and stops;

- **Will the non-moving side move with help?**

If only one (1) side of the room is moving, then with someone's assistance press the switch to extend or retract the room while pushing the non-moving side in the appropriate direction. On larger rooms it may be necessary to have two (2) or more people pushing the room.

- **Non-moving side moved manually.**

Try to push the non-moving side in and out. If a motor shaft has broken then it will be possible to move that side of the room several inches by hand. Larger rooms may require several people to push.

## IN-WALL slide system maintenance

Check all four (4) gear racks installed on the exterior side-walls of the slide room for debris (if found, remove debris immediately).

## NOTICE

Never 'jump' or charge the auxiliary battery from the power connections on the In-Wall Controller. Always do this at the auxiliary battery.

## Hide-A-Bed Sofa



1. Remove the seat back cushions.



2. Lift up and out on the front edge of the sofa, uncovering the legs.
3. Fully extend the legs on both sides.

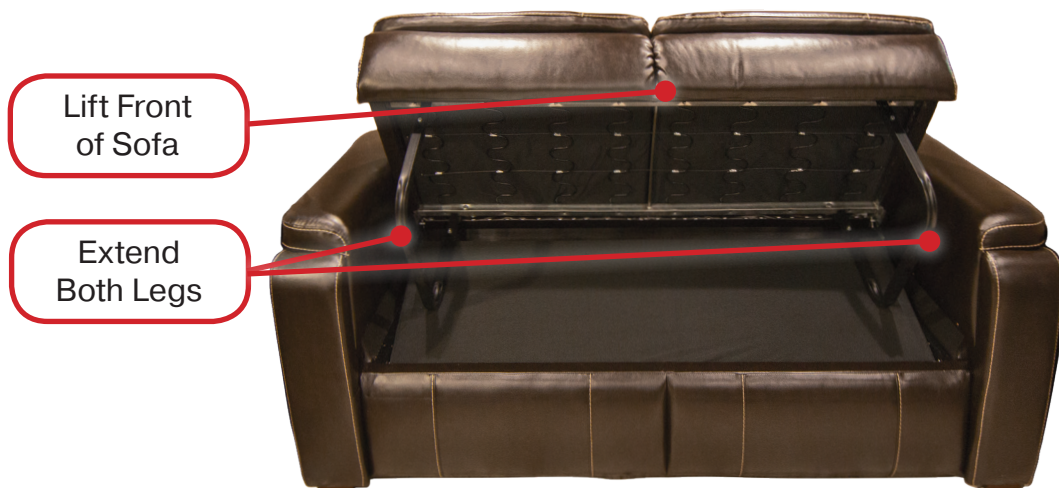

4. Pull the sofa forward and place the legs flat on the floor.
5. Pull the sofa back forward, and lay flat.



Converted Hide-A-Bed Sofa.



This page is intentionally blank.

## Interior Care

### Cleaning the Interior

To keep the value of your RV, perform regular maintenance using the proper materials and procedures.

- Check the component manufacturer's information for the recommended cleaning agent.

Using the wrong cleaner may result in damage to the surfaces in your RV. To check if a cleaner will cause damage, test it in a small, out of sight area, or contact your dealer for assistance.

**DO NOT use flammable liquids or sprays to clean your RV.**

### Cabinetry & Tables

- To keep them looking like new, regularly dust the hardwood doors, cabinet fronts and tables.
- Use a soft cloth dampened with a cleaning polish or mild detergent solution.
- Avoid using ammonia based products or silicone oils as they may cause damage if used over a long period of time.
- Although the finish is durable and resistant to most household spills, they should be wiped up promptly to avoid any potential problems.
- Avoid prolonged exposure to direct sunlight, high temperatures or high humidity. These conditions can cause damage to both the finish and the wood itself.

### Pantry

- Use the pantry to store items you wish to take with you as you travel and camp.
- The cabinetry has been designed to accommodate normal camping items (i.e., paper plates, flatware, cookware, etc.) which are bulky but not necessarily heavy.
- Ensure items stored in the pantry are secured so they do not shift during travel.

Remember your RV's load capacity is designed by weight, not volume, so you cannot necessarily use all available space.

## Paneling

- To clean, use a mild solution of soap and lukewarm water with a soft sponge or cloth.
- Do not use abrasive cleaners as they could cause the vinyl to scratch and turn dull.
- Grease spots and stubborn dirt can be cleaned off with an all-purpose spray

## Countertops

To prevent permanent damage:

- Always use hot pads or trivets under hot pans, dishes, or heat producing appliances such as frying pans.
- Always use a cutting board; never use a knife on the countertop.
- Avoid harsh chemicals such as drain cleaners, oven cleaners, etc.
- Do not let cleaners with bleach set on the top. Wipe them off promptly.

### **Laminate countertops**

Glass rings, food spills, water spots and smudges usually wipe off with a damp sponge. Stubborn stains can be removed with a general-purpose spray cleaner. Some stains can be removed by squeezing fresh lemon juice over the stain and allowing the juice to soak for approximately forty-five minutes. After 45 minutes, sprinkle baking soda over the lemon juice and rub with a soft cloth.

### **Solid surface countertops**

Solid surface materials are easy to care for. Soapy water, ammonia based cleaners (not window cleaners as they can leave a waxy build up that may dull the surface) or commercially available solid surface cleaners will remove most dirt and residue from all types of finishes. A damp cloth followed by a dry towel will remove watermarks. Disinfect the surface periodically with diluted household bleach (one part water to one part bleach).

For additional information on the removal of difficult stains or surface damage repair, refer to the countertop manufacturer's user guide.



## Flooring

Always test a cleaning agent in an inconspicuous area for colorfastness.

### Carpet

Vacuum regularly with a vacuum cleaner with a revolving brush or beater bar. Be sure the vacuum does not have teeth, combs or rough edges as they may damage the carpet. It is important to remove loose soil and debris while it is on the surface. Heavily traveled areas (i.e., walkways, areas in front of the furniture) may be protected with small throw rugs to prolong the life of the carpet.

Some spills contain chemicals that will destroy carpet fibers and dyes. If you have doubts about what caused the spot, contact a professional carpet cleaner. Because of the additional dirt typically associated with camping, we recommend that you vacuum the carpet frequently. Have tough and deep stains professionally steam cleaned. Use spot removers for minor spills. Always test the carpet for color fastness in an inconspicuous area before using any product.

### Vinyl flooring

Periodically vacuum or sweep to remove dirt and gritty particles. Although most common spills will not permanently stain the vinyl floors, they are usually easier to remove if wiped up before they set. Simply blot with a paper towel and wipe clean with a damp cloth. As part of a regular maintenance program, sponge mop the entire floor. Do not use dish detergents or vinegar and water because they will dull your floor.

To care for the vinyl floor covering, use a damp mop with water and a mild cleaner. **DO NOT SOAK THE FLOORING.** Use care to avoid wetting the carpet edges. To prevent the linoleum from *yellowing*, avoid cleaners that contain oil based solvents (i.e. cleaners containing lemon oil, Murphy's Oil Soap, etc.).

## Free-Standing Table & Chairs

The extendable free-standing dinette table can be positioned to seat up to four people. To prevent damage, the standard free-standing dinette table should be closed in the travel position and the free standing chairs fastened down securely when you are traveling.

## Furniture Upholstery

To retain the value of your RV, maintain the furniture upholstery carefully and keep the interior clean. Vacuum the furniture regularly using a soft brush attachment to remove any loose dirt or debris.

### Fabric upholstery

Fabric should be professionally cleaned if it becomes stained or soiled. For more information, refer to the specific furniture manufacturer's care instructions.

### Suede

Suede should be professionally cleaned if it becomes stained or soiled.

### Vinyl upholstery

Vinyl should be professionally cleaned if it becomes stained or soiled. If a spill does occur, use water based cleaners **ONLY**. Blot up the spot, but **DO NOT** rub it in or saturate the area.

**DO NOT** use solvents. They may have an adverse reaction to the specific backing of your upholstery fabric. **DO NOT** dry clean vinyl components. If they are dry cleaned, the vinyl on the reverse side will shrink, become hard and crack.

*Clean the **suede** or **vinyl** upholstery **ONLY** as recommended. Using other processes than those listed may produce undesired results and possibly damage the upholstery. This type of damage is not warrantable.*

## Recliner Sofa or Loveseat

Like a residential recliner, the recliner sofa or loveseat sections have controls allowing you to recline the individual sections. To revert each recliner section back to the upright position, gently apply pressure to the recliner leg rest. Refer to the furniture manufacturer's care instructions for this product.

## ABS Plastic

ABS plastic components will retain their original beauty with reasonable care. Dust and wipe clean with soft, damp cloth or chamois, wiping gently. Do not use gritty or abrasive particle soaps or scouring compound to clean ABS plastic.

**AVOID** using *Citrus* or *biodegradable* cleaners containing D-Limonene; these cleaners may damage plastic materials.

## Decor Items

### Decor glass

Use a glass cleaner to remove smudges, smears and spots. If there is any decorative etching on the decor glass, use care when cleaning around that area.

### Window treatments, curtains, blinds and shades

Dust occasionally with a vacuum and soft brush attachment. Professionally clean only.

## Shower Walls

To clean the plastic shower walls, use a mild detergent soap and warm water. NEVER use gritty or abrasive particle soaps or scouring compounds to clean the plastic.

## Sink & Shower Fixtures

Use mild dish soap and water to clean these fixtures. Do not use harsh chemicals or sprays. A mild solution of vinegar and water works well to remove hard water spots and stains from the sink or shower fixture.

## Stainless Steel Sink & Appliances

- DO NOT use abrasive cleaners, scouring pads or steel wool.
  - DO NOT use oven cleaner or any cleaners containing bleach or chloride.
  - Hard water that evaporates on a Stainless Steel surface can leave spots.
1. Dampen a soft cloth in warm water mixed with a mild dish soap.
  2. Wipe the surface. Clean with the grain, not across.
  3. Rinse the cloth and wipe again.
  4. Blot the surface dry with a towel to prevent water spots.

Glass cleaner or a cleaners made specifically for stainless steel may also be used. BEFORE cleaning the entire surface, test the cleaner on a small hidden area.

## Exterior Care

The RV exterior is comprised of many different materials including; fiberglass gel-coat, automotive grade paint finishes, plastics, glass, sealant, and aluminum.

There is an increased chance of damage to the exterior finish, the longer a foreign substance remains on the surface. Frequent washing and waxing is the best way to protect your RV from this damage.

The following materials deposited on the RV's surface may result in corrosion, staining, and/or chemical spotting:

- Road Tar, Dirt, and Dust
- Road Salt and Sodium Chloride
- Bird Droppings / Bugs / Tree Sap
- Acid Rain / Industrial Fallout / Pollution
- UV Exposure and Moisture

## Cleaning the Exterior

Frequent washings also protect your RV from environmental elements, such as rain, snow and salt air.

- Wash your RV as soon as possible if it becomes contaminated with foreign material.
- Avoid parking under trees or near ocean sea salt.
- DO NOT *scrape* ice or snow from the painted surface, *brush off* the affected area.
- If anti-freeze, gasoline or any solvents are spilled on the painted surface, rinse the area with water immediately.
- Bugs and bird droppings should be rinsed off daily.

### Washing

- DO NOT wash the RV in direct sunlight.
- Park in the shade and spray RV with water to remove dust.
- Next, using an ample amount of clean water and a sponge or car washing mitt, wash the RV from top to bottom.
- Use a mild car-washing soap if necessary.

- Rinse thoroughly and wipe dry with a chamois or soft cloth.
- Carefully clean the joints and flanges of the slideout, doors, etc. where dirt is likely to remain.

Some types of hot water washing equipment apply high pressure and heat to the RV. Excessive *heat* can cause distortion or damage to resin parts. Excessive *pressure* can flood the RV's interior.

- DO NOT take your RV through automatic car washes.
- Avoid forcing water inside the RV, which could possibly damage component parts.
- Extreme caution should be used with any type of pressure sprayer around all attachments, doors, windows, appliance vents, etc.
- Keep the washing nozzle about 16 inches (40 cm) or more away from the RV body.
- When washing around the door, vent and glass areas, hold the nozzle at right angles to the surface.
- If chalking occurs, first wash and wax a small area to see if the luster returns.
- Have your dealer inspect the RV if the exterior becomes scratched, nicked or cracked.

### **During cold weather**

If the slideout or door is frozen, opening it by force may tear off or crack the rubber gasket that is installed around the slideout or door. Pour warm water on the gasket to melt the ice (wipe off the water thoroughly after opening the slideout or door). To prevent the weather stripping from freezing, treat it with a silicone spray.

Salt and other chemicals spread on winter roads can have a detrimental effect on the RV's underbody. If your RV is exposed to these conditions:

- Wash the exterior of your RV.
- Carefully spray the underbody with a high-pressure hose, remove any mud or debris that could trap and hold salt or moisture.
- After washing your RV, wipe off all water drops from the rubber parts around the slideout and doors.

## NOTICE

Do not use waxes containing high-abrasive compounds. Such waxes remove rust and stains effectively, but they are also harmful to the luster of the surface, since they may scrape off the coating. Further, they are detrimental to glossy surfaces, such as the grille, garnish, moldings, etc. Do not use gasoline or paint thinners to remove road tar or other contamination to the painted surface.

## NOTICE

Do not use a buffer and a buffing compound as it may damage the exterior surface. Please contact a professional paint body shop for assistance.

## NOTICE

Do not allow plastic to come into contact with brake fluid, engine oil, grease, paint thinner, or battery acid. These will damage plastic. Use a soft cloth and a mild detergent solution to wipe away any such contact.

### Waxing your RV

Wax your RV once or twice a year, or when painted surfaces do not shed water well. Use a soft cloth to apply a small amount of wax to the painted surfaces. After the wax has dried, polish the RV with a dry, soft cloth. Do not wax your RV in direct sunlight. Wax it after the surfaces have cooled. Do not apply wax to any area having a flat black finish as it can cause discoloration. If the finish has been stained with wax, wipe off the area with a soft cloth and warm water.

When waxing the area around the various openings, do not apply any wax on the weather strip. If it is stained with wax, the weather strip cannot maintain a weatherproof seal around the opening.

### Polishing your RV

If painted surfaces have been severely damaged and have lost their original luster and color tone, polish the surface lightly with a fine polishing compound. Avoid limiting your polishing to the damaged surface only; polish a somewhat wider area, moving the polishing cloth in one direction. After polishing, flush the compound from the surface and apply a coat of wax to regain a beautiful luster.

### Damaged paint

To prevent corrosion, touch up small cracks and scratches in the paint coat of the FW front cap as soon as possible with touch-up film or paint. Carefully check the body areas facing the road and the tires for damage to the paint coat caused by flying stones, etc. To purchase touch-up paint, use the closest automotive paint match (available locally) as possible.

### Cleaning plastic parts

Use a sponge or chamois to clean plastic parts. Use warm water and a soft cloth or chamois to remove any white residue from dark colored plastic surfaces. Do not use a scrubbing brush or other hard tools as they may damage the plastic surface. Do not use wax containing abrasives that may damage the plastic surface.

### Chrome parts

To prevent chrome parts from spotting or corroding, wash with water, dry thoroughly, and apply a non-abrasive automotive wax. If the chrome is severely damaged or pitted, use a commercially available chrome polish product.

## Exterior Roof

3-4 times per year, clean the Superflex roof and inspect all roof sealant. While you are cleaning, also clean and inspect the roof vents (including the sealant) for cracks.

- **Do not use sharp tools (putty knife) that could puncture the Superflex roof membrane.**
- If any voids or cracking are found, remove any loose sealant *by hand*.
- If the loose sealant cannot be pulled off by hand, it still has good adhesion to the Superflex roof membrane and should be left alone.
- Using a medium-bristled scrub brush, clean all areas to be resealed with a non-abrasive household cleaner, such as Top Job® or Spic-N-Span®.
- This area must be dry before continuing.
- **Solvents should not be used during cleaning.** Solvents can damage existing sealant and may weaken plastic roof components.
- Apply a generous amount of **Alpha Systems 1010 Non-Sag Sealant** over top of any existing sealant needing resealed.
- Please note ONLY ALPHA SUPPLIED SEALANTS SHOULD COME IN CONTACT WITH THE SUPERFLEX ROOF MEMBRANE.

## Sidewall Vents

Water heater, furnace and refrigerator exterior doors need to be kept clean and free of obstructions while the appliances (if so equipped) are in use. Inspect the refrigerator and holding tank vents for blockages from bird or insect nests, spider webs, leaves, etc.

### **WARNING**

As with the surface of any roof, a rubber roof can be very slippery, especially when wet. If you go up on your roof we recommend extreme caution and suggest that you navigate the roof on your hands and feet. This distributes the weight more evenly and helps reduce the possibility of falling.

### **NOTICE**

Failure to properly maintain or re-seal your RV may result in serious water damage to the roof and other parts of the RV. This damage is not covered by the Limited Base Warranty and Limited Structural Warranty.

### **NOTICE**

Do not use petroleum distillates to clean the roof as they may cause permanent damage.

## Windows

Any ventilating window may permit water inside, especially during heavy rainstorms. Condensation will also cause water to accumulate on windows and in the tracks. The window glass can be cleaned normally with a sponge and water. Use glass cleaner to remove wax, oil, grease, dead insects, etc. After washing the glass, wipe it dry with a clean, soft cloth.

## Trailer Frame

Rocks, sand, road debris, climate (salt air exposure) and ice inhibiting chemicals used during the winter months will damage your frame's painted exterior, inviting rust and other deterioration.

- Regularly inspect all exposed areas of the frame.
- To maintain protection, **clean** and **repaint** any chipped areas or rust spots.

### NOTICE

Do not add items to the RV rear bumper. Add-on items will eventually damage your bumper. Damage caused by such aftermarket equipment installation or improper loading voids the Limited Base Warranty & Limited Structural Warranty.

## Rear Bumper

The rear bumper of your RV is not designed to carry cargo. Items that extend beyond the bumper will place undue strain on the bumper. Over time, weight added to the bumper will cause damage from the motion created while traveling. In addition, extra weight behind the axle may reduce the hitch weight (leading to adverse handling conditions from wind gusts and/or passing traffic).

## Roof Ladder

Your RV may be equipped with an optional roof ladder. The RV roof has decking under the rubber roof membrane to allow you to walk on the roof (with caution) to do maintenance.

## Sealant

Sealants perform a very important function and should be inspected closely and regularly maintained. We incorporate many different types of sealants, including butyl/putty, black butyl-encapsulated foam, silicone (clear and colored), roof sealant and foam. In general, sealants do not have a "set" lifetime. Varying environmental factors affect the pliability and adhesiveness of sealants.

### WARNING

If your RV is equipped with a roof ladder:

- DO NOT exceed the weight limit of 300 lbs.
- DO NOT leave items attached to ladder while traveling.



The sealants may become damaged due to exposure to the elements, freezing temperatures, ultraviolet, and air pollution. If deteriorated, repair immediately to prevent damage. A quick walk around the RV before leaving may help prevent potential problems during trips and vacations. Your dealer service or parts manager can help you obtain the correct sealant(s).

You or your dealer **MUST**:

- Inspect all sealants, a minimum of every six months. Make sure to check the roof and all four sides of the RV including all moldings, doors, vents and exterior attachments.
- Replace the sealant if you notice any cracks, peeling, voids, gaps, breaks, looseness or any sign of physical deterioration.
- Reseal at least one time each year as preventative maintenance. Always use the same type of sealant that was removed.

If you notice water inside the RV, immediately have the dealer check for the source of the leak. Failure to correct the leak may result in serious damage to your RV; this damage may not be warrantable. If you have questions and/or need assistance with sealing your RV, consult with your RV dealer.

## RV Storage

Properly preparing your RV for storage during periods of non-usage will prevent problems from arising. It will also make it easier to get started again for the following camping trip or season. To prevent costly freeze-ups, winterize the plumbing system when it will not be in use for an extended period of time, especially if it is stored in colder climates.

Periodically inspect your RV for damage during storage, and seal off any area that can offer an entry point for rodents, birds or insects. When storing your RV, it is recommended that the auxiliary battery (customer supplied) be disconnected to avoid battery discharge.

See the **following page**, *Winterizing The Exterior*.

## Winterizing The Exterior

- **BEFORE storing for the winter, be sure your RV is properly *Winterized*.**

1. Check your roof and other surfaces for any damage or potential leaks that could go unnoticed until it is too late.
2. Close all windows and roof vents.
3. Turn OFF 12-volt DC/120-volt AC/propane to the refrigerator; defrost and clean.
4. Use crumpled newspaper or open boxes of baking soda in the refrigerator to eliminate odors during storage.
5. Shut OFF the propane cylinder valve(s).
6. Cover all external outlets/vents (furnace, exhaust, etc.) to prevent mice or other rodents from entering.
7. Cover the roof air conditioner (if so equipped).
8. Disconnect 120-volt AC power to the RV.
9. DO NOT use the leveling legs during storage.
10. Drain all water lines.
11. Flush, *then* drain all holding tanks; fresh water, water heater, gray water and black water.
12. Remove all (customer supplied) batteries from the RV, and store in a place where they will not freeze. Batteries that have been frozen will never hold a proper charge.
13. Thoroughly wash the interior and the exterior of your RV.
14. Store your RV indoors, under a roof or purchase a *breathable* cover for use during storage.
15. To prevent weather checking and other UV damage, cover tires that are exposed to sunlight.



Damage from birds, rodents, insect, etc., is not covered under the Limited Base Warranty and Limited Structural Warranty applicable to your RV.

### NOTICE

Excessive snow, 8" or more, or ice, 2" or more, places excessive weight on the RV roof. Remove excessive snow or ice as needed. Care **MUST** be exercised to not damage the roof material when removing snow & ice. Excessive weight can damage the roof, seals, etc. Water leaks and poor fit or operation are the results of this damage.

### Snow removal

During the storage period, remove snow from the top of your RV to prevent damage to the unit's structure.

## Suggested Maintenance Checklist

This list is a quick reference sheet for suggested areas of regular maintenance. Review all manufacturer's operators manuals supplied with your RV to perform these listed maintenance items.

### Prior to First Trip

- Inspect and reseal as needed.
- Have the propane system checked for leaks by your dealer.
- Check wheel lug nuts at specified intervals to listed torque specifications. Re-torque as needed.
- Sanitize the fresh water system.
- Test the safety alarms.

### First Two-Hundred Miles

- Check wheel nuts at specified intervals to listed torque values. Re-torque as needed.
- Have brakes adjusted by a qualified service technician.

### Each Trip

- Inspect and reseal as needed.
- Check the auxiliary battery. Have the propane system checked for leaks by your dealer.
- Check running lights.
- Check tire pressure and wear, including spare. Make sure the tires are cold when checking the tire pressure.
- Check wheel nuts at specified intervals to listed torque values. Re-torque as needed.
- Flush out water heater tank.
- Test brakes.
- Test safety alarms.



## Basic Troubleshooting

### Air Conditioner (Roof)

#### Will not operate

- Make sure unit is turned on.
- Check circuit breakers in coach.
- Have your dealer check to see if there is proper voltage from shoreline or generator.

#### Unit runs, but coil freezes and compressor cycles too soon

- Control setting may be too low, cycles too soon.
- Make sure the filter is clean and unobstructed.
- Have the coolant level checked by a qualified service facility.

#### Does not get cold enough

- Start the unit before the day gets too hot.
- To offset heat gain:
  - Close all windows and blinds.
  - Keep entrance doors closed.
  - Use awnings.
  - Avoid using heat-producing appliances.
- Make sure that the outside coil is not blocked or damaged.
- Have your dealer check to make sure that you have the proper voltage.

Should your air conditioner still not work after completing the above checks, contact a qualified service facility to perform more extensive testing.

### Electrical Power

#### No AC power to RV

- Check circuit breakers at power center. The 120-volt circuit breaker may be off or tripped.
- Have a dealer check that there is power to the shoreline receptacle.

## Furnace

### Furnace does not ignite and/or cycles frequently

- Check that propane tank is full.
- Remove any obstruction over furnace exhaust.
- Inspect exhaust tube for any obstructions.
- Check furnace fuse in fuse panel. Replace if necessary.
- Check that the return air grill is unobstructed. Remove anything that is stored in the furnace compartment that could block airflow.
- Check that all heat outlet registers are open and unobstructed.
- Check that 12-volt power is present.
- Contact your dealer if the problem persists.

## Interior Lights

### Lights flicker

- Loose or defective bulb. Tighten or replace as needed.
- Converter is overheating. Open the cover to cool down and reduce the load by turning off some 12-volt lights.

### Lights dim or are half bright

- Low battery connection. Check battery condition and recharge if necessary.
- Possible converter malfunction. Have the converter checked by an authorized service center.
- Possible loss of ground. Check for loose wire connection.

## Microwave

### Will not operate

- Door open or timer OFF. Close door and turn ON timer.
- No power to oven. Check power supply and circuit breaker.

**WARNING**

DO NOT attempt to repair or adjust the furnace.

Turn off the thermostat and furnace gas control valve, then contact your dealer or authorized service center.



*To Access the ON/OFF Switch, Remove the Outside Furnace Panel*

## Monitor Panel

### **No lights on panel when switch is pressed**

- Check battery voltage and condition.
- Check fuse at the battery; if fuse is good have a dealer or qualified RV technician check the condition of panel.

### **Holding tank lights deliver false readings (i.e. 1/3 or 2/3 indication)**

- Verify tank is empty.
- Debris may be built up across probes. Clean and flush tank using four parts vinegar mixed to two parts water.

### **Propane indicator display indicates E or F all the time**

- Ensure propane gas tank is full.
- If display is F, check the wiring or sending unit for malfunction.

Have it inspected by a certified technician.

## Outside Receptacle

### **No power to outside receptacle**

- Make sure you have power to the shoreline.
- Check breaker on generator.
- GFCI receptacle switch may be off or tripped. Re- set GFCI at receptacle in bathroom or kitchen.
- Check the breaker in the power center or panel box.
- Contact a dealer or qualified RV technician if problem is not resolved.

## Oven

### **Oven slow to heat up, poor baking, poor ignition of burners, pilots won't stay lit, popping sound from top burners, carbon on pilot shield or burner flame too low or too high**

- A defective gas pressure regulator may cause these conditions. Have the regulator tested by your gas dealer or a certified RV technician.

**Top burner or oven burner won't light or won't stay lit**

- Check position of top burners and flash tubing.
- Clean clogged burner ports with a toothpick.
- See Oven Owner's Manual for proper care and maintenance.

**Gas smell**

- Check all connections with leak detector solution.

**Food burns on the bottom**

Oven too full for proper circulation. Use smaller pans or put less food in the oven.

## Portable Generator (Customer Supplied)

**Starter engages while holding the start button down, but generator does not start**

- Generator may be out of fuel. (Generator will not operate when the fuel tank is less than  $\frac{1}{4}$  full).
- Generator may be low on oil. Check the oil level.

**Nothing happens when the generator start button is pushed**

- Check that the battery disconnect switch button is pushed.
- Check the 12 Volt fuse on generator.
- Reset the circuit breaker if necessary.
- Contact your dealer or a qualified RV technician if the problem is not resolved.

**Generator starts, but lacks electrical power**

- The breaker switches may be off or tripped at generator. Reset the breaker if necessary.
- The breaker may be off or tripped inside power center. Reset the main breaker if necessary.

**Generator makes clicking sound when trying to start**

- Battery condition may be low. Recharge if necessary.
- Check for poor ground or poor battery connection.

 **DANGER**

IF YOU SMELL PROPANE GAS  
**STOP!**

Quickly and carefully perform the 6-step procedure in the red box.

 **WARNING**

WORKING WITH PROPANE CAN BE DANGEROUS.

Always have repairs to your LP system performed by your dealer or a certified professional.

## Propane Gas

### Smell gas in or around unit

- Propane tanks may be overfilled.

#### IF YOU SMELL PROPANE

1. **Extinguish any open flames, pilot lights and all smoking materials.**
2. **Do not touch electrical switches.**
3. **Shut off the propane supply at the container valve(s) or propane supply connection.**
4. **Open doors and other ventilating openings.**
5. **Leave the area until odor clears.**
6. **Have the propane system checked and leakage source corrected before using again.**

**FAILURE TO COMPLY COULD RESULT IN EXPLOSION  
RESULTING IN DEATH OR SERIOUS INJURY**

## Refrigerator

### The control panel lights are not illuminated

- Check coach circuit breakers and GFCI receptacle.
- Verify that refrigerator is plugged into the 120-volt outlet.
- If using propane gas, verify house batteries have adequate charge.

### Lights are illuminating, but no cooling

- Use a proper power source that is available and cooling operation to specification.
- Make sure the refrigerator unit is level.
- Allow sufficient time for proper cool down and try to load with food that is already cold.
- Have a qualified RV technician check that the vents and chimney at the rear of the refrigerator are clear and unobstructed.
- Have a qualified RV technician make sure the burner jets or burners are not dirty or damaged.
- Have a qualified RV technician check the fuses in the black electrical box on the rear of the refrigerator.



**Heavy frost build up on the evaporator fins**

- Defrost the freezer and refrigerator.
- Have the refrigerator checked by your dealer or a qualified RV technician.

## Running Lights

**Running lights not working**

- Blown fuse. Replace fuse with one of the same ampere rating.
- Bad bulbs. Replace the bulbs with new.

## Slideout

**Room moves in and out very slowly, binds or squeaks**

- Lubricate the slide-out tubes and rollers with light spray lube.

**Water is getting in at the bottom corners of the room**

- Verify exterior seals are against the room at the top corners and not turned in when the room is out (horizontal seal overlaps vertical). Also, check for voids in the seal on the slide roof and side panels.
- Make sure weep hole in ramp pan is open and unobstructed.

**Room will not move in or out**

- Check the auto-resetting fuse located by the slideout motor. (See the manufacturer's manual).
- Check battery condition and state of charge. Recharge if necessary.

**Rollers leave tracks in the carpet as the room extends**

- This is normal. There are many pounds of weight pressing these rollers down on the carpet and rollers will compress the nap of the carpet down. Raking the nap or vacuuming will solve the problem.

## Termination Valve

### Termination valve leaks

- Debris keeps valve from seating. Clear debris from and around valve O-ring set.
- Bad gasket. Have your dealer or qualified RV technician replace gasket with new.

## TV Antenna

### Poor TV reception

- Power jack is OFF. Turn ON power jack switch.
- Bad connections at TV or wall plate. Make sure the connections are good at both TV and wall plate.
- Antenna not pointed in direction of sending station. Point antenna in proper direction.
- Cut or torn cable. Have your dealer or qualified RV technician replace bad cable where needed at TV and antenna.

### Antenna will not rotate

- Make sure button on the side of knob is fully depressed.
- Possible obstruction (tree branch, etc.). Remove the obstruction.
- Check to make sure roof sealant is not restricting rotation.

## Waste Tank

### Waste tank (black) will not drain

- Buildup or debris in tank. Check for buildup in tank at stool.
- Always use a minimum amount of biodegradable toilet paper.
- Always use plenty of water when flushing.
- Check termination valve for proper operation.

## Water Heater

### Temperature-pressure relief valve weeping

- Weeping or dripping of relief valve while water heater is running does NOT mean it is faulty.

### There is an odor that smells like rotten eggs

- If your fresh water source has a rotten egg odor, you will need to find another source of fresh water before flushing or refilling the entire RV water storage system.

### To remove the hydrogen sulfide (rotten egg) odor:

1. Turn off your main water supply; that is your pump or your water hookup source.
2. Drain your water heater tank by removing the drain plug. Approximately two quarts of water will remain in the bottom of the tank. If you notice during the draining that the water is flowing sporadically or slowly, instead of flowing freely, you should open your relief valve to allow air into the tank.
3. If the water does not flow freely, take a small gauge wire or coat hanger and push through the drain opening to eliminate any obstructions.
4. After completely draining the tank, flush the entire system from the water inlet all the way to the holding tank. To flush, use four parts vinegar mixed with two parts of water.

## Water Heater, Continued

5. If you decide to use air pressure (55 PSI max.), it may be applied either through the inlet or outlet on the rear of the tank. It may also be applied through the relief valve port.
  - First remove the relief valve. You may then insert your air pressure through the relief valve support flange.
  - With the drain valve open, the air pressure will force the remaining water out of the tank.
  - If air pressure is unavailable, you may flush the tank with fresh water. Water should be pumped into the tank with the assistance of the on board water pump or with the assistance of external water pressure.
  - External pressure may be pumped into the unit either through the inlet or outlet found on the rear of the water tank, or using the relief valve inlet located on the front of the unit.
6. Continue this flushing process for approximately five (5) minutes allowing ample time for the fresh water to agitate the stagnant water on the bottom of the tank and force the deposits through the drain opening.
7. Upon completion of the steps above, close the drain plug as well as the relief valve. Refill with fresh water, circulate and rinse.

If you use your vehicle frequently or for long periods of time, flushing the water heater several times a year will prolong the life of the water heater storage tank.

### **Water heater will not fire up**

- Check for obstructions in burner tube and exhaust.
- Check 12 Volt power for possible blown fuse.
- Bad circuit board. See your dealer.

## Water Pump

### **Pump will not start**

- Check that house battery disconnect switch is on.
- Check pump switch at monitor panel.
- Check fuse in power center.
- Check to see if water is frozen.

### **Will not prime, sputters (no discharge, but the motor runs)**

- Check to see if there is water in the tank, or if air collected in the hot water heater.
- Check for frozen water lines or water tank.

### **Pump will not shut off, runs when faucet is closed**

- Turn off the pump or city water supply.
- Check for damp areas around plumbing appliances.
- Check plumbing for leaks and inspect for leaky valves on toilet.
- Have the pump checked by your dealer or a qualified RV technician.

## Water System

### **Wet areas near water connections, pump runs while the faucets are closed, and no other fresh water fixtures are being used**

- There is a possible leak,
- Close all low point water drains and tank drains.
- Turn off all fixtures.
- Check all fixtures and connections for tightness.
  - Do not over tighten fittings as this may cause additional leakage.

## Glossary

**AC ELECTRICITY** – Alternating current also known as shoreline power. For purposes of this manual, it refers to 120-volt AC (abbreviated 120 VAC).

**AMP** – Short for ampere, the electric current unit of measure. RV sites with electric hookup will specify the maximum amps supported, which generally come in units of 20, 30, or 50 amps. The RV power connector must match the various plugs of the site amp rating.

**ANODE ROD** – An anode rod, when used in a water heater, attracts corrosion causing products in the water. These products attack the anode rod instead of the metal tank itself. The anode rod should be inspected yearly and changed when it is reduced to about 1/4 of its original size. The rods are used in steel water heater tanks - an aluminum tank has an inner layer of anode metal to accomplish the same thing. Anode rods should not be installed in aluminum tanks!

**AUXILIARY BATTERY** – For purposes of this manual, the term refers to the 12-volt DC group 27 deep cycle battery (customer purchased) that should be installed in your RV.

**AWNING** – A roof-like structure made of canvas or other artificial materials which extends from the RV body to provide shade. Awnings are generally placed over entrances. Some extend and stow manually while others are operated electrically.

**BLACK WATER** – Term associated with the sewage holding tank. The toilet drains directly into this tank.

**BLUE BOY** – Also known as a honey pot. Refers to a portable waste holding tank that has wheels on one end. These tanks often are manufactured out of blue plastic, hence the nickname.

**BOON DOCKING** – Also known as dry camping. Camping without electrical and water hookups.

**BREAKAWAY SWITCH** – An electrical switch on trailers designed to engage the breaks in case the trailer breaks away from the tow vehicle. The switch is connected by a cable to the tow vehicle. Breakaway is detected when the switch cable is pulled out during vehicle separation.

**BRAKE CONTROLLER** – A device (customer supplied) mounted under the dash of a towing vehicle to control the braking system of the RV. Most brake actuators are based on a time delay application; the longer the brakes are applied tighter the trailer brakes react

**BRITISH THERMAL UNIT (BTU)** – Measurement of heat that is the quantity required to raise the temperature of one pound of water 1°F. RV air-conditioners and furnaces are BTU-rated.

**CAMBER (WHEEL ALIGNMENT)** – The number of degrees each wheel is off of vertical. Looking from the front, tops of wheels farther apart than bottoms means "positive camber". As the load pushes the front end down, or the springs get weak, camber would go from positive to none to negative (bottoms of wheels farther apart than tops).

**CAMPER** – For purposes of this manual, this term refers to your fifth wheel RV.

**CAMPING** – An outdoor recreational activity involving the spending of one or more nights in a tent, primitive structure or RV at a campsite with the purpose of getting away from civilization and enjoying nature.

**CAMPSITE** – The term usually means an area where an individual or family might go camping.

**CARBON MONOXIDE** – A colorless, odorless and poisonous gas.

**CARGO WEIGHT** – The actual weight of all items added to the Curb Weight of the vehicle or trailer. This includes personal cargo, optional equipment, and tongue or king pin weight.

**CARGO CARRYING CAPACITY (CCC)** – Equal to GVWR minus each of the following: UVW, full fresh (potable) water weight (including water heater), full propane weight and SCWR.

**CITY WATER** – Term associated with the water supply you hook up to at the campsite. It is called city water because water is pulled from a central outside source (like a city) and not the fresh water tank.

**CONDENSATION** – A result of warm moisture laden air contacting the cold window glass. Keeping a roof vent open helps to reduce the humidity levels. Added roof vent covers help to prevent cold air from dropping down through the vent while still allowing moist air to escape. Using the roof vent fan when showering or the stove vent fan when cooking also helps prevent excess moisture buildup.

**CONVERTER** – A device that converts 120 volt A/C (alternating current) to 12 volt DC (direct current). The RV devices mostly run on 12 volt DC power that is supplied by the battery, which allows the RV to function independently. When "shore power" (an electrical supply) is available, the converter changes the voltage from 120 to 12 volt to supply the appliances and to recharge the battery.

**CURB WEIGHT** – The actual weight of a vehicle or trailer, including all standard equipment, full fuel tanks, full fresh water tanks, full propane bottles, and all other equipment fluids, but before taking on any persons or personal cargo.

**CURBSIDE** – This refers to the side of the camper that faces the curb when parked. Also referred to as the door side or DS.

**DC ELECTRICITY** – Direct current also known as auxiliary battery power. For purposes of this owner's manual, it refers to 12-volt DC (abbreviated 12 VDC).

**DEALER** – For purposes of this manual, this refers to the independent dealer authorized to sell and/or service your camper by Grand Design RV. This term will be used in this context unless specified otherwise.

**DINETTE** – Booth-like dining area. Table usually drops to convert unit into a bed at night.

**DRAIN TRAP** – This is the curve that is in all drains. Water is trapped in the curve and creates a barrier so tank odors cannot escape through the drain.

**DRY CAMPING** – Camping when there is no city water hookup or shore power (i.e., using only the water and power available in the camper and not from any other source).

**DRY WEIGHT** – The actual weight of a vehicle or trailer containing standard equipment without fuel, fluids, cargo, passengers, or optional equipment.

**DSI (Direct Spark Ignition)** – This term refers to the method of igniting the main burner on a propane fired appliance. The burner is lit with an electric spark and the flame is monitored by an electronic circuit board. This ignition system is used in refrigerators, furnaces and water heaters. There is now a version of stove tops that light the burners with a DSI ignition.

**DUAL ELECTRICAL SYSTEM** – RV equipped with lights, appliances which operate on 12-volt battery power when self-contained, and with a converter, on 110 AC current when in campgrounds or with an on-board generator

**DUALY** – A truck having two wheels on each side of the rear axle for a total of four wheels

**DUCTED A/C** – Air conditioning supplied through a ducting system in the ceiling. This supplies cooling air at various vents located throughout the RV.

**DUCTED HEAT** – Warm air from the furnace supplied to various locations in the RV through a ducting system located in the floor. (similar to house heating systems).

**DUMP STATION** – Site where you drain your gray water (waste) and your black water (sewage) tanks. In most states, it is illegal to drain your tanks anywhere except dump stations.

**DUMP VALVE** – Another name for the T-handle valve used to release and drain the black tank (sewage) and gray tank (waste).

**EGRESS WINDOW** – The formal name for the emergency escape window. Egress windows are identified by their labeling.

**FIFTH WHEEL (FW)** – A trailer and hitch configuration connected to the tow truck directly above the rear axle by way of a special fifth wheel hitch. This causes several feet of the connected trailer to hang over the tow truck, placing about 15 to 25% of the trailer's weight on the rear axle of the truck. Commercial trucks and trailers use this hitch configuration. Also commonly spelled as 5th wheel.

**FIVER** – Another name for a fifth wheel RV.

**FRESH WATER** – The fresh water system provides potable water to the fresh water tank, kitchen sink, shower, bathroom lavatory, toilet, water heater and outside shower.

**FRESH WATER TANK** – Tank for holding fresh water for drinking, cooking, and bathing while not connected to a city water supply.

**FULL HOOK-UP SITE** – A campsite that has city water, shore power and sewer hook-ups or connections available



**FULL TIMERS OR FULL TIMING** – The term used for people who live in their RV full time, or at least the vast majority of their time.

**GALLEY** – The kitchen in an RV.

**GENERATOR** – An engine powered device fueled by gasoline or diesel fuel, and sometimes propane, for generating 120-volt AC power.

**GENSET** – Abbreviation for generator set.

**GOOSENECK** – A trailer and hitch configuration connected to the tow truck directly above the rear axle by way of a standard ball hitch in the truck bed and a vertical, slender arm on front of the trailer. Gooseneck hitching is common on horse and utility trailers, but rarely found on RV's.

**GRAY WATER** – Term associated with the waste water holding tank. Water from the sink drains, shower and washer/dryer (if so equipped) go into this tank.

**GROSS AXLE WEIGHT RATING (GAWR)** – The MAXIMUM ALLOWABLE WEIGHT each axle assembly is designed to carry, as measured at the tires, therefore including the weight of the axle assembly itself. GAWR is established by considering the rating of each of its components (tires, wheels, springs, axle), and rating the axle on its weakest link. The GAWR assumes that the LOAD IS EQUAL ON EACH SIDE.

**GROSS CARRYING CAPACITY (GCC)** – Means the maximum carrying capacity of your camper. The GCC is equal to the GVWR minus UVW. The GCC will be reduced by the weight of fresh water or other tanks, propane, occupants, personal items or dealer installed accessories.

**GROSS COMBINED WEIGHT RATING (GCWR)** – The MAXIMUM ALLOWABLE COMBINED WEIGHT of the tow vehicle and attached towed vehicle. GCWR assumes that both vehicles have functioning brakes, with exceptions in some cases for very light towed vehicles, normally less than 1,500 pounds. (Check your tow vehicle's towing guide.)

**GROSS TRAILER WEIGHT RATING (GTWR)** – The MAXIMUM TOWED VEHICLE WEIGHT. Each component (receiver, drawbar, ball) of a ball-type hitch has its own rating. Some ball-type hitches have separate ratings when used with a weight distributing system.

**GROSS VEHICLE WEIGHT RATING (GVWR)** – The MAXIMUM ALLOWABLE WEIGHT of the fully loaded vehicle, including liquids, passengers, cargo, and the tongue weight of any towed vehicle.

**HEAT EXCHANGER** – A device that transfers heat from one source to another. For example, there is a heat exchanger in your furnace - the propane flame and combustion products are contained inside the heat exchanger that is sealed from the inside area. Inside air is blown over the surface of the exchanger, where it is warmed and the blown through the ducting system for room heating. The combustion gases are vented to the outside air.

**HEAT STRIP** – A heat strip is an electric heating element located in the air conditioning system with the warm air distributed by the air conditioner fan and ducting system. They are typically 1500 watt elements (about the same wattage as an electric hair dryer) and have limited function. Basically they "take the chill off."

**HIGH PROFILE** – A fifth-wheel trailer with a higher-than-normal front to allow more than 6 feet of standing room inside the raised area.

**HITCH** – The fastening unit that joins a movable vehicle to the vehicle that pulls it.

**HITCH WEIGHT** – The amount of the camper's weight that rests on the tow vehicle. It should be approximately 12% - 15% with conventional trailers; approximately 18% -21% for fifth wheels.

**HOLDING TANKS** – There are three different holding tanks on most RVs; fresh water tank, gray water tank and black water tank. The fresh water tank holds fresh water that can be stored for later use. The gray water tank holds the waste water from the sinks and showers. The black water tank holds the waste from the toilet.

**HONEY WAGON** – Euphemism for the sewage pumping truck. Honey wagons are used to empty RV holding tanks in places where full hookups and dump stations are not available.

**HOOKUPS** –The ability of connecting to a campground's facilities. The major types of hookups are electrical, water and sewer. If all three of these hookups are available, it is termed full hookup. Hookups may also include telephone and cable TV in some campgrounds.

**HOUSE BATTERY** – One or more batteries in a RV for operating the 12 volt lights, appliances, and systems. House batteries can be 12 volt units tied in parallel or pairs of 6 volt batteries tied in series (to double the voltage). The term house battery is of more significance in motor homes because they contain one or more other batteries for the operation of the engine, referred to as the chassis or starting batteries.

**HULA SKIRT** – Term used for a type of dirt skirt accessory some RVers use on the back of their motorhome to aid in the protection from debris thrown from their rear wheels to the vehicles directly behind them or being towed behind them. This dirt skirt is usually the length of the rear bumper and resembles a 'short' version of a Hawaiian 'hula-skirt', hence the term.

**INVERTER** – An inverter is a device that changes 12 volt battery power to 120 volt AC power. It is used when "boon docking" (camping without hookups) to power certain 120 VAC only devices like a microwave oven. The amount of available power depends on the storage capacity of the batteries and the wattage rating of the inverter.

**IRON RANGER** – A fee collection box used at campgrounds that do not have full time attendants. Upon entrance to the campground, you deposit your nightly fee(s) in an envelope with your name and site number and drop this in the collection box. At some time during the day, a park ranger will make rounds of the campgrounds and collect the fees. You will often see these in National Park and National Forest campgrounds.

**ISLAND QUEEN OR ISLAND KING** – A king or queen-sized bed with walking space on both sides.

**JACKKNIFE** – 90° angle obtained from turning/backing fifth wheel or travel trailer with tow vehicle. Jackknifing a short bed truck towing a fifth wheel without the use of a slider hitch or extended fifth wheel pin box can result in damage to the truck cab or breaking out the back window of the truck cab from the truck and fifth wheel "colliding".

**KING PIN** – The pin by which a fifth wheel trailer attaches to the truck. It slides into the fifth wheel hitch and locks in place.

**KING PIN WEIGHT** – The actual weight pressing down on the fifth wheel hitch by the trailer. The recommended amount of King Pin Weight is 15%-25% of the GTW, also called Pin Weight.

**LAMINATE** – A sandwich of structural frame members, wall paneling, insulation and exterior covering, adhesive-bonded under pressure and/or heat to form the RV's walls, floor and/or roof.

**LANDING GEARS** – See Leveling Jack.

**LEVELING** – Positioning the RV in camp so it will be level, using ramps (also called levelers) placed under the wheels, built-in scissors jacks, or power leveling jacks.

**LEVELING JACK** – A jack lowered from the underside of trailers and motor homes for the purpose of leveling the vehicle. A leveling jack is designed to bear a significant portion of the RV's weight.

**LP GAS** – Liquefied Petroleum Gas, commonly written as "LP Gas". Two examples of LP Gas are propane and butane. LP Gas is heavier than air in gas form and about half the weight of water in liquid form. LP gas is used to fuel appliances in the RV, such as the stove, oven, water heater and refrigerator. Propane tanks are usually rated as pounds or gallons.

**LOW POINT** – The lowest point in the plumbing. Drains are placed here so that water will drain out of the lower end of the camper when flushing or winterizing the water system. These drains must be closed when you fill the water tank.

**MOTORHOME (MH)** – A motor vehicle built on a truck or bus chassis and designed to serve as self-contained living quarters for recreational travel.

**NET CARRYING CAPACITY (NCC)** – The MAXIMUM WEIGHT of all personal belongings, food, fresh water, propane, tools, dealer installed accessories, etc., that can be carried by the RV.

**NONPOTABLE WATER** – Water not suitable for human consumption.

**OEM** – This refers to the original equipment manufacturer of the individual appliance or component.

**PARK MODEL** – A travel trailer that requires park facilities to function. It lacks holding tanks and dual-voltage appliances, requiring to be plugged into water, sewage, and electrical facilities. A park model is more of a small mobile home than a recreational vehicle, in appearance and function.

**PART TIMERS** – The term used for people who use their RV more than usual (more than just a few weekend trips a year), but who still use it less than full time.

**PATIO MAT** – Carpet or woven mat for use on ground outside of RV. Used whether or not a concrete patio pad is available where camping.

**PAYLOAD CAPACITY** – The maximum allowable weight that can be placed in or on a vehicle, including cargo, passengers, fluids and fifth-wheel or conventional hitch loads.

**PILOT** – A pilot is a small standby flame that is used to light the main burner of a propane fired appliance when the thermostat calls for heat. Pilots can be used in furnaces, water heaters, refrigerators, ovens and stove tops.

**PORPOISING** – A term used to define the up and down motion in an RV while traveling

**POWER SOURCE** – Also referred to as shore power, this refers to the receptacle outlet you are using to plug in your shoreline power cord. This can be a campsite power box or electrical box, a residential receptacle outlet specifically wired for your camper or a generator (customer supplied).

**PRIMITIVE SITE** – A campsite that may have city water, shore power or sewer hook-ups but not all of them; primitive sites may have no hook-ups or connections at all.

**PROPANE** – LPG, or liquefied petroleum gas, used in RVs for heating, cooking and refrigeration. Also called bottle gas, for manner in which it is sold and stored. This is the proper term in the RV industry when referring to "LP Gas."

**PULL-THROUGH SITES** – Campsites you can drive through and park (without having to back up into the site).

**REFER** – Slang for "refrigerator". Refrigerators are often found in either a "two-way" or "three-way" operating mode. Two-way: has a gas mode and an AC mode. Three-way: has a gas mode, AC mode, and 12v DC mode. The coolant used in RV refrigeration is ammonia. The two most common manufacturers of RV refrigerators are Norcold and Dometic.

**RIG** – What many RVers call their units.

**ROADSIDE** – This refers to the side of the camper that faces the road when it is parked. Often called the off-door side.

**ROOF AIR CONDITIONING** – Air conditioning unit mounted on roof of RV, to cool the RV when it is parked. When moving, most RVs are cooled by separate air conditioning units which are components of the engine, or they may be cooled by a roof top if a proper size generator is installed.

**RV** – Short for Recreation Vehicle, a generic term for all pleasure vehicles which contain living accommodations. Multiple units are RVs and persons using them are RVers.

**RVDA** – Abbreviation for Recreational Vehicle Dealer's Association.

**RVIA** – Abbreviation for Recreational Vehicle Industry Association

**SELF CONTAINED** – RV which needs no external electrical, drain or water hookup. Thus, it can park overnight anywhere. Of course, self-contained units can also hook up to facilities when at campgrounds.

**SANITIZATION** – Refers to the camper's fresh water system that has been sanitized with chlorine bleach before use or after storage.

**SHORELINE POWER CORD** – This is the electrical power cord that runs from the camper to the campsite shore power outlet.

**SLEEPING CAPACITY WEIGHT RATING (SCWR)** – The manufacturer's designated number of sleeping positions multiplied by 154 pounds (70 kilograms).

**SLIDEOUT** – A compartment added to an RV to increase interior space. It slides into the body during travel and slides out when parked.

**SNOWBIRD** – Term for someone in a northern climate that heads "south" in winter months.

**STINKY SLINKY** – Slang for the sewer hose, constructed from a spiral wire covered with vinyl. One end attaches to the RV piping and the other into the local sewer dump facilities

**STREETSIDE** – The part of the vehicle on the street side when parked. (Also referred to as the off door-side or ODS.)

**SURGE PROTECTOR** – Device (customer supplied) that is installed at the power supply location designed to prevent "surges" or "spikes" in electrical current that may damage the RV's electrical/electronic components.

**SWAY** – Fishtailing action of the trailer caused by external forces that set the trailer's mass into a lateral (side-to-side) motion. The trailer's wheels serve as the axis or pivot point. Also known as "yaw."

**THERMOCOUPLE** – A thermocouple is a device that monitors the pilot flame of a pilot model propane appliance. If the pilot flame is extinguished the thermocouple causes the gas valve to shut off the flow of gas to both the pilot flame and the main burner.

**TIP OUT** – The term used for an area or room in an RV that tips out for additional living space. The Tip-Out was generally used in older RVs. Newer RVs mainly use a slide-out.

**TIRE RATINGS** – The MAXIMUM LOAD that a tire may carry is engraved on the sidewall, along with a corresponding COLD inflation pressure. A reduction in inflation pressure requires a reduction in load rating. Tire manufacturers publish charts that establish the load capacity at various inflation pressures.

**TOE (WHEEL ALIGNMENT)** – Toe is the measure of whether the front of the wheels (looking down from the top) are closer (toe-in) or farther (toe-out) than the back of the wheels.

**TONGUE WEIGHT, TONGUE LOAD, VERTICAL LOAD (TWR/TLR/VLR)** – Tongue Weight, Tongue Load, Vertical Load Rating Different terms for the MAXIMUM VERTICAL LOAD that can be carried by the hitch UNLOADED.

**TRAILER BRAKES** – Brakes that are built into the trailer axle systems and are activated either by electric impulse or by a surge mechanism. The overwhelming majority of RVs utilize electric trailer brakes that are actuated when the tow vehicle's brakes are operated, or when a brake controller is manually activated. Surge brakes utilize a mechanism that is positioned at the coupler, that detects when the tow vehicle is slowing or stopping, and activates the trailer brakes via a hydraulic system (typically used on boats).

**TRAVEL TRAILER (TT)** – Also referred to as "conventional trailers," these types of rigs have an A-frame and coupler and are attached to a ball mount on the tow vehicle. Travel trailers are available with one, two or three axles. Depending upon tow ratings, conventional trailers can be towed by trucks, cars or sport-utility vehicles.

**UMBILICAL CORD** – Wiring harness which connects the trailer to the tow vehicle during transport. The umbilical cord supplies the trailer with DC power for charging the batteries and operating DC equipment. It also operates the trailer brakes and signal lights. (Also referred to as the 7-way power cord.)

**UNDERBELLY** – The RV's under-floor surface, which is protected by a weatherproofed material.

**UTQGL (UNIFORM TIRE QUALITY GRADE LABELING)** – A program that is directed by the government to provide consumers with information about three characteristics of the tire: tread wear, traction and temperature. Following government prescribed test procedures, tire manufacturers perform their own evaluations for these characteristics. Each manufacturer then labels the tire, according to grade.

**UV DEGRADATION** – A breaking down of material due to the sun's harsh ultraviolet rays.

**UNLOADED VEHICLE WEIGHT (UVW)** -The weight of a vehicle as built at the factory with full fuel, engine (generator) oil and coolants. It does not include cargo, fresh water, propane, occupants, or dealer installed accessories.

**WALLY WORLD** – Slang term used by RVers to describe a Wal-Mart.

**WASTE WATER TANKS** – The gray water tank holds the waste water from the sinks and showers. The black water tank holds the waste from the toilet.

**WATER PRESSURE REGULATOR** – Device (customer supplied) installed on the water hose attached to city water to limit the water pressure entering the RV. Most regulators limit water pressure to 40 psi.

**WEEKENDERS** – People who own their RV's for weekend and vacation use.

**WEIGHT & LOAD** – These terms are generally used interchangeably. For the purposes of understanding RV applications:

Vehicles have **WEIGHT**, which impart **LOADS** to tires, axles and hitches.

Scale measurements taken when weighing, are **LOADS** carried by the tires.

The measured "loads" are used to calculate Gross Vehicle Weight (GVW), Gross Axle Weight (GAW), Gross Combination Weight (GCW), and hitch loads.

**WET WEIGHT** – The weight of the vehicle with the fuel, freshwater and propane tanks full.

Note these important weights:

**Propane** • **4.2** lbs. per gallon

**Water** • **8.3** lbs. per gallon

**Gasoline** • **6.3** lbs. per gallon

**Diesel fuel** • **6.6** lbs. per gallon

**WIDE BODY** – An RV having an external body width greater than 96 inches (8 feet). The most common wide-body widths are 100" and 102."

**WINTERIZED** – Refers to a camper that has been prepared for storage. The water systems have been drained and RV antifreeze has been added to protect the water lines and drains. The low point drains should be in the open position.

**WORK CAMPER** – A person living in an RV and working. Many spell it as "workamper" after the web site and service by that name.

**YAW** – Fishtailing action of the trailer caused by external forces that set the trailer's mass into a lateral (side-to-side) motion. The trailer's wheels serve as the axis or pivot point. Also known as "sway."

# Index

7-Way Wire Harness . . . . .	71
12-Volt DC System . . . . .	87
30-Amp or 50 Amp Power Cord . . . . .	83, 84
120-volt AC system . . . . .	84
120-Volt Circuit Breakers . . . . .	85
Additional Safety Precautions . . . . .	51, 52
Air Conditioner . . . . .	152
Appliances . . . . .	145
Auto Level . . . . .	81
Auxiliary Battery . . . . .	88
Battery Disconnect Switch . . . . .	90
Black/Grey Water Holding Tanks . . . . .	105
Black/Grey Water System . . . . .	103
Black Tank Flusher . . . . .	107
Breakaway Switch . . . . .	72
Cargo Carrying Capacities . . . . .	56
Cargo Carrying Capacity Label . . . . .	55
Cold Weather Use . . . . .	49
Component Supplier Contact Information . . . . .	30
Component Manufacturer Warranty Information . . . . .	31
Condensation . . . . .	46
Draining the Fresh Water System . . . . .	100
Drain Pipes with P-Traps . . . . .	105
Electrical Load Ratings . . . . .	91
Electrical Systems . . . . .	83
Electronics . . . . .	148
Emergency Egress Window . . . . .	37
Emergency Warranty Repair . . . . .	14
Emergency Weather Planning . . . . .	34
Emptying the Black & Grey Water Tanks . . . . .	106
Exterior Care . . . . .	170
Exterior Roof . . . . .	173



Federal Certification Label . . . . .	55
Fifth Wheel Pin Box Hitch . . . . .	72
Fire Extinguisher . . . . .	36
Fire Safety . . . . .	35
Formaldehyde . . . . .	45, 46
Fresh Water Holding Tank . . . . .	95
Fresh Water System . . . . .	93
Furnace . . . . .	152
Heating and Cooling . . . . .	151
Heat Pump . . . . .	153
Hide-A-Bed . . . . .	162
Indoor Air Quality . . . . .	43
Landing Legs . . . . .	77
Leveling the RV . . . . .	77
Lippert Electric Slideout System . . . . .	156
Lippert Ground Control 3.0 System . . . . .	78
Maximum Load Rating . . . . .	56
Microwave . . . . .	145
Monitor Panel . . . . .	94
Nautilus P1 Manual . . . . .	109
Nautilus P2 Manual . . . . .	125
Occupant Safety . . . . .	33
Patio Awning . . . . .	153
Pet Safety . . . . .	34
Plumbing Systems . . . . .	93
Pre-Travel Information . . . . .	53
Propane System . . . . .	137
Propane Gas Alarm . . . . .	41, 42
Propane Regulator . . . . .	141
Range Hood with Oven . . . . .	146
Refrigerator . . . . .	145
Required Maintenance Schedule . . . . .	202

Roof Vent . . . . .	151
RV Braking System . . . . .	70
RV Storage . . . . .	175
Sanitizing the Fresh Water System . . . . .	101
Schwintek In-Wall Slideout System . . . . .	158
Sealant . . . . .	174
Slideout Systems . . . . .	154
Smoke Alarm . . . . .	38
Suggested Maintenance Checklist . . . . .	177
Thermostat . . . . .	151, 152
Tire and Loading Information Label . . . . .	55
Tire Maintenance . . . . .	59
Tire Pressure & Load Limits . . . . .	60
Tire Safety Tips . . . . .	63
Toilet . . . . .	104
Towing and Leveling . . . . .	69
Troubleshooting, Basic . . . . .	178
TV Roof Antenna . . . . .	150
Unhitching from a Tow Vehicle . . . . .	80
UVW (Unloaded Vehicle Weight) . . . . .	54
Warranty, (1) One Year Limited Base . . . . .	17
Warranty, (3) Three Year Limited Structural . . . . .	23
Warranty Service . . . . .	13
Water Control System . . . . .	100
Water Heater . . . . .	96
Weighing Your Tow Vehicle and RV . . . . .	57, 58
Weight Labels . . . . .	55
Weight Ratings & Definitions . . . . .	54
Wheel Nut Torque . . . . .	67
Windows . . . . .	174
Winterizing the Plumbing System . . . . .	102

## Customer Notes

---

Required Maintenance Schedule								
Maintenance Item	Every Trip	Monthly	Every 3 Months	Every 6 Months	Annually	Before/After Storage	As Required	<p><b>Procedure to be performed.</b>                      Maintenance schedules are minimum requirements. Extended use, extreme temperatures, high humidity or other extreme conditions will require more frequent maintenance.</p>
Appliances					●	●		Check settings and adjustments per manufacturer's guide.
		●						Make sure burner tubes/vents are clean and unobstructed.
					●	●		Clean and sanitize.
Awnings						●		Wash with warm water and mild detergent.
					●	●		Clean and lube moving parts with WD-40.
Axles & Suspension						●		Check u-bolts, springs and hangers for damage.
					●	●		Check torque - all bolts (see axle manufacturing guide for specs).
Baggage Doors		●					●	Confirm the doors seal tightly and are not leaking.
				●			●	Spray lock tumblers with dry graphite.
Brakes & Wheel Hubs					●			Check amp draw / shoe wear / adjustment (see manufacturing guide for specs).
					●		●	Lube bearings (as needed).
Electrical System	●		●			●		Check and service batteries.
			●		●	●		Test all GFI outlets.
					●	●		Service generator (if equipped) per manufacturer's manual.
Entry Door(s)	●					●		Make sure door latches and locks function properly.
				●		●		Lube hinges with light oil or WD-40.
				●		●		Adjust screen door and latch.
Entry Steps				●		●		Clean and lubricate with lithium spray.
Exterior Fiberglass and Metal			●			●		Wash with warm water and mild detergent
				●				Apply non-abrasive wax except on decals.
Exterior Moldings			●			●		Inspect sealant for voids / gaps /cracks.

<b>Required Maintenance Schedule</b>								
<b>Maintenance Item</b>	<b>Every Trip</b>	<b>Monthly</b>	<b>Every 3 Months</b>	<b>Every 6 Months</b>	<b>Annually</b>	<b>Before/After Storage</b>	<b>As Required</b>	<p><b>Procedure to be performed.</b>                      Maintenance schedules are minimum requirements. Extended use, extreme temperatures, high humidity or other extreme conditions will require more frequent maintenance.</p>
Frame & Underbelly					●	●		Check for damage, loose wires and debris. Clean as necessary.
			●				●	Check frame for rust and touch up as necessary.
Hitch / Coupler					●	●		Check for damage& wear. Clean and lubricate (with grease)
LP System					●			Have systems tested for leaks by qualified dealer.
					●			Have pressure and regulator settings checked by qualified dealer.
Plumbing System			●		●	●		Check hoses, fittings and pipes for leaks. Tighten as required.
					●	●		Lubricate termination valve cables (WD-40 or lithium grease).
					●			Winterize system (cold weather locations).
Roof & Roof Attachments			●			●		Inspect voids, gaps and cracks. Reseal as necessary.
				●		●		Clean roof with water and mild detergent.
					●	●		Clean and lube roof vent mechanisms with light oil.
Safety Equipment	●			●		●		Check operation of detectors. Remove and replace batteries every 6 months if equipped.
				●	●			Test and check fire extinguishers for proper charge.
	●	●			●			Test and confirm egress (exit) windows function properly.
Slide Rooms	●							Check slide roof for debris and clear.
	●		●			●		Check and clean all seals.
Wheels and Tires	●		●			●		Check wheels for proper lug torque.
			●			●		Inspect tires for wear and damage.
	●	●				●		Check for proper tire inflation.







11333 County Road 2  
Middlebury, IN 46540  
(574) 825-8000  
[www.granddesignrv.com](http://www.granddesignrv.com)